

- COMPOSANTS :
- Q1 : SECTIONNEUR AVEC INTERVERROUILLAGE PORTE
 - F1 : FUSIBLE MOTEUR 1
 - F2 : FUSIBLE MOTEUR 2
 - F4 : FUSIBLE CARTE MERE
 - C1 : CONDENSATEUR DE MARCHE MOTEUR 1
 - C2 : CONDENSATEUR DE MARCHE MOTEUR 2
 - AVC : ALARME VISUELLE
 - ASC : ALARME SONORE

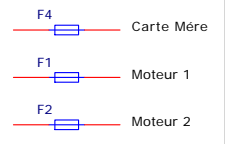
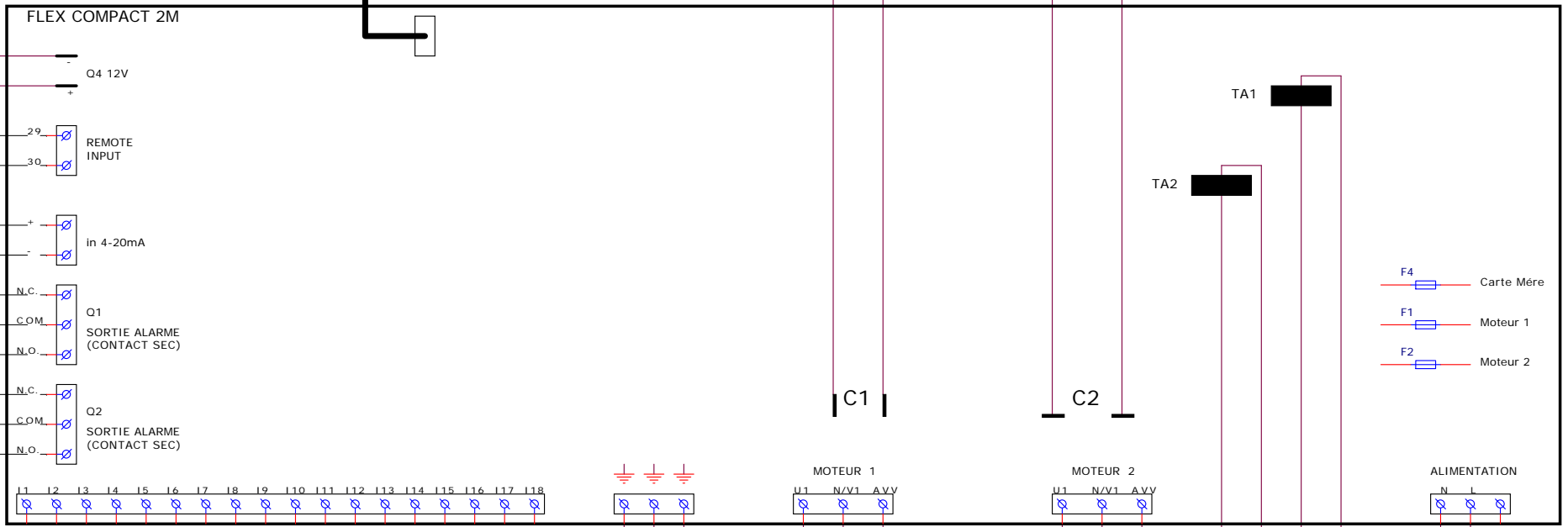
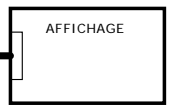
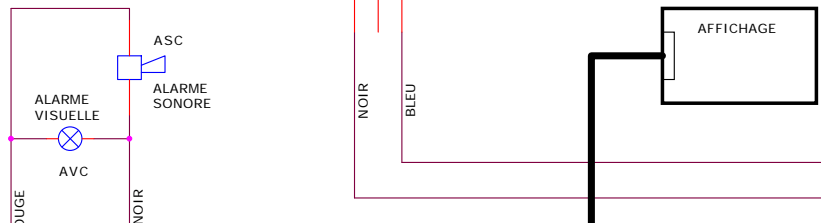
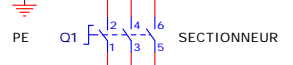

(POUR LES CONNEXIONS AUXILIAIRES, CONSULTEZ LE MANUEL D'UTILISATION ET D'INSTALLATION)

NOTE: RACCORDEMENT DES POMPES DE FORAGE

U = NOIR

N/V1 = GRIS

AVV = BRUN

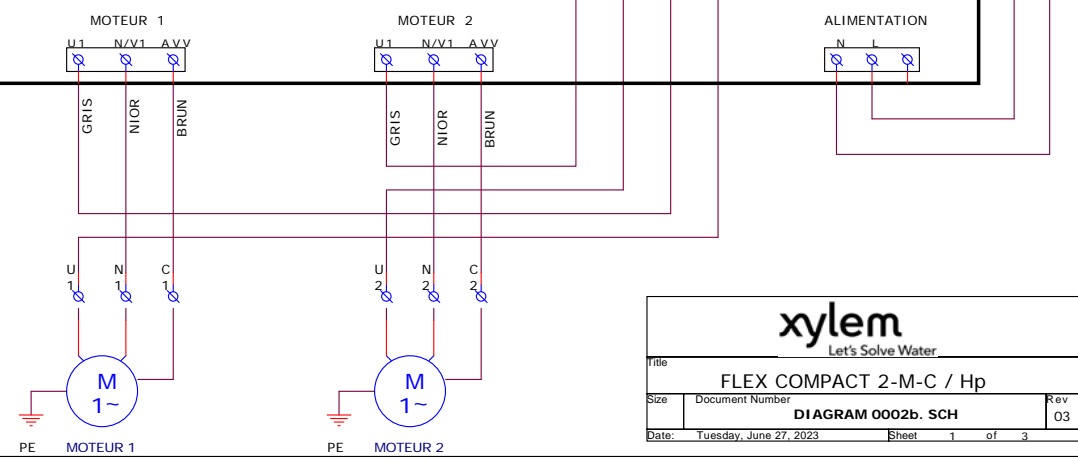

xylem
Let's Solve Water.

title FLEX COMPACT 2-M-C / Hp

Size Document Number **DIAGRAM 0002b. SCH** Rev 03

Date: Tuesday, June 27, 2023 Sheet 1 of 3

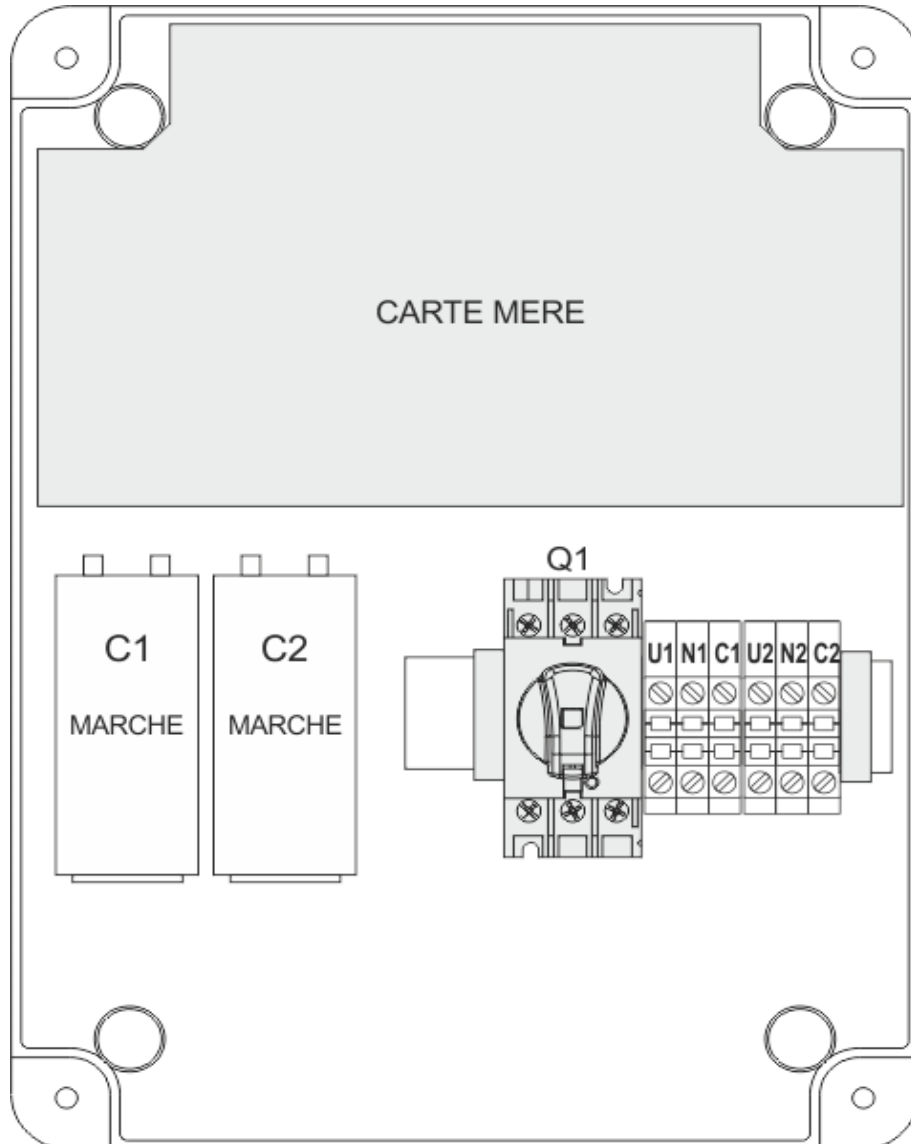

DISPOSITION INTERNE

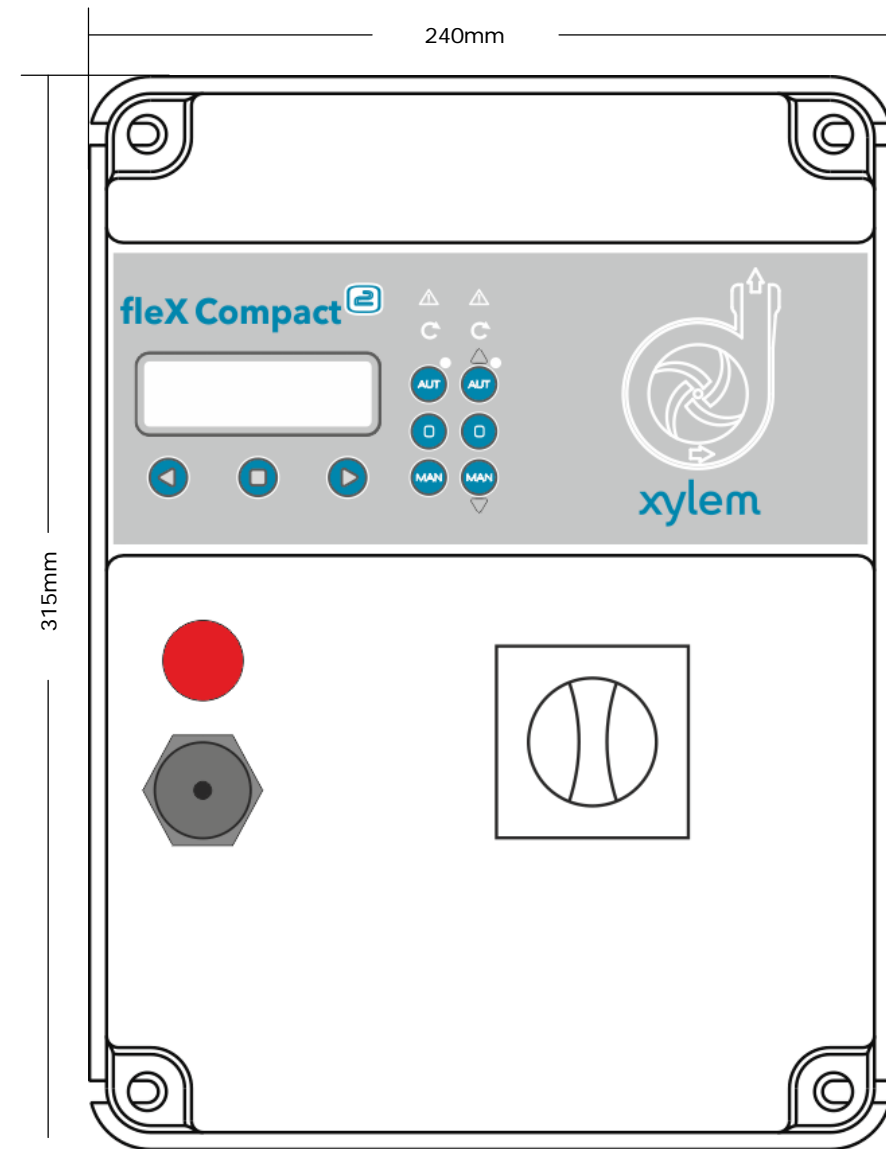

DIMENSIONS (H x L x P) : 315 x 245 x 170 mm

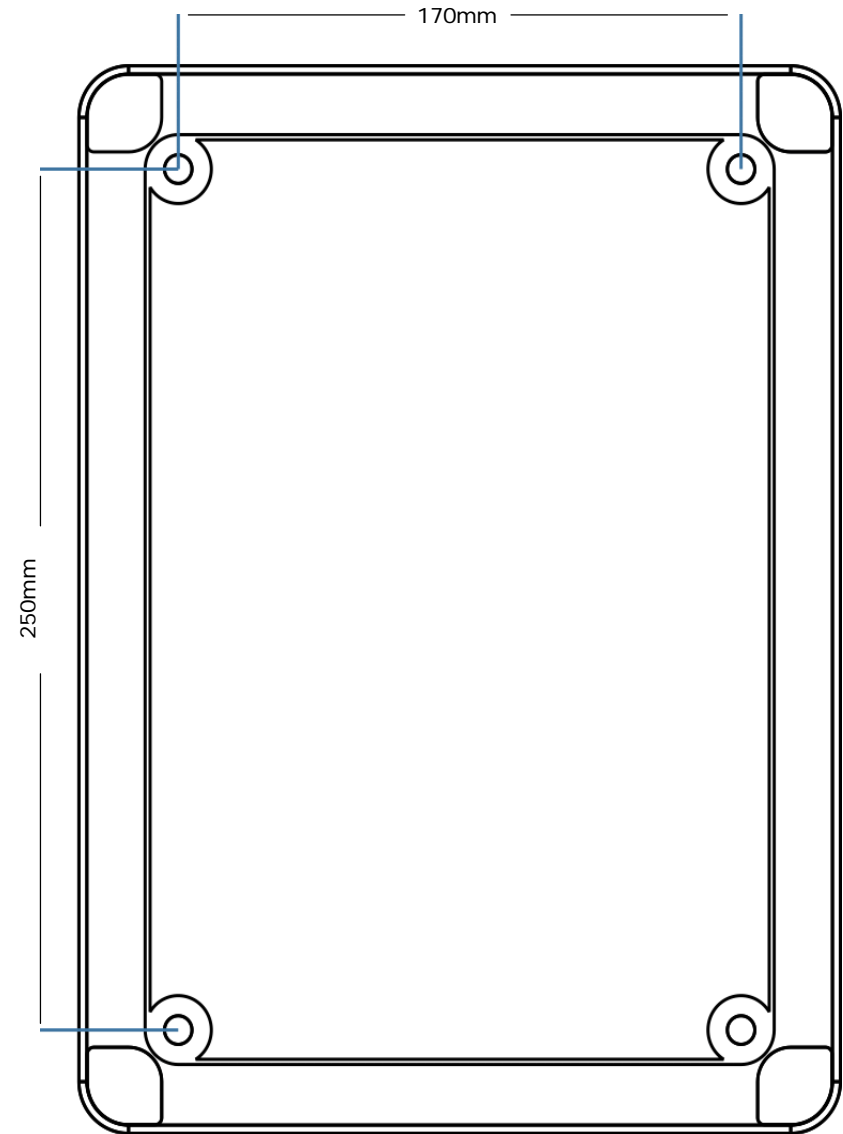

FIXATIONS (H x L) : 250 x 170 mm