

CR 3200

THERMOREACTOR



a xylem brand

CR 3200 - Contents

1	Overview	5
1.1	Components of the thermoreactor	6
2	Safety	7
2.1	Safety information	7
2.1.1	Safety information in this operating manual	7
2.1.2	Safety signs on the product	7
2.1.3	Further documents providing safety information	7
2.2	Safe operation	8
2.2.1	Authorized use	8
2.2.2	Requirements for safe operation	8
2.2.3	Unauthorized use	8
2.3	Personal protective equipment	9
3	Commissioning	10
3.1	General handling instructions	10
3.2	Scope of delivery	10
3.3	Unpacking and positioning	10
3.4	Initial commissioning	11
4	Basic principles of operation	13
4.1	Operating and display elements	13
4.1.1	Keys	14
4.1.2	Display	15
4.1.3	Control lamps (LEDs)	15
4.2	Operating modes	15
5	Operation	17
5.1	Inserting and removing the reaction cells	17
5.2	Starting a temperature program	17
5.3	Stopping a temperature program	18
5.4	Settings	19
5.4.1	Setting the display contrast	19
5.4.2	Setting the timer for the reaction time	21
6	Maintenance, cleaning, disposal	22
6.1	Maintenance	22
6.2	Exchanging the fuses	22
6.3	Cleaning the enclosure	23
6.4	Cleaning the thermoblock of spilled cell contents	23
6.5	Disposal	24
7	What to do if...	25
8	Technical Data	26

9 Replacement parts and accessories / options27

10 Index29

1 Overview

The CR 3200 thermoreactor is a dry temperature control device for use in the laboratory. It facilitates and safeguards the digestion with reaction cells.

8 temperature programs are permanently set.

- 1: 148 °C for 120 minutes
- 2: 120 °C for 30 minutes
- 3: 120 °C for 60 minutes
- 4: 120 °C for 120 minutes
- 5: 100 °C for 60 minutes
- 6: 148 °C for 20 minutes
- 7: 150 °C for 120 minutes
- 8: 100 °C for 30 minutes

8 further temperature programs can be freely programmed. The reaction temperature can be set from room temperature to 170 °C, the heating time in the range 0 ... 180 min.

The thermoreactor accommodates 24 reaction cells with an outer diameter of 16 mm.

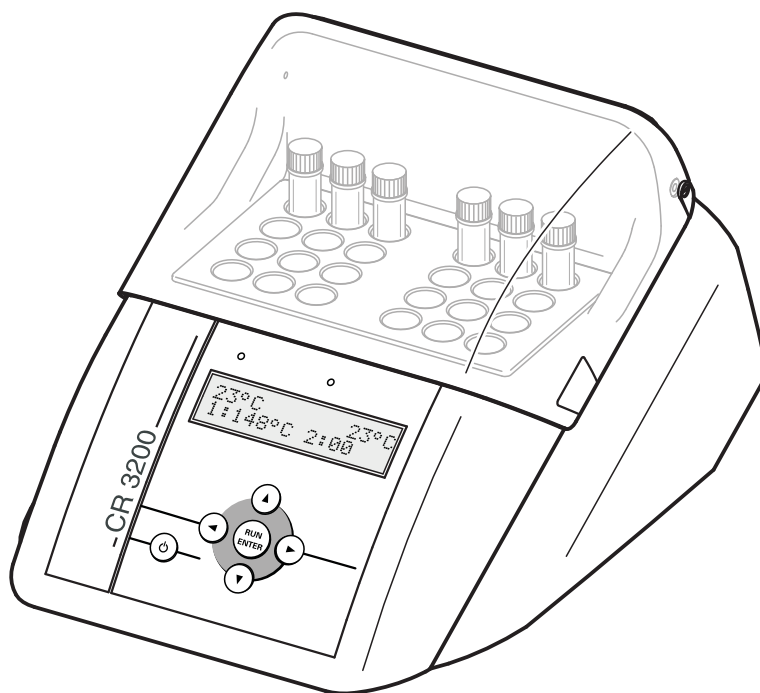

You will find information on accessories in the WTW catalog LABORATORY AND FIELD INFORMATION or on the Internet.

1.1 Components of the thermoreactor

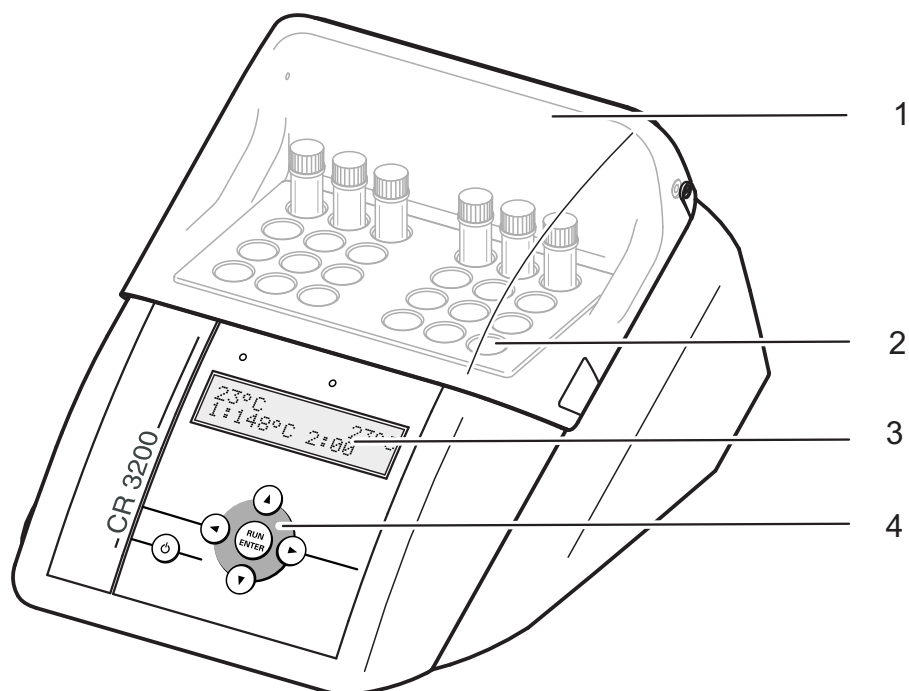

1	Protective cover
2	Thermoblock with cell shafts
3	Sample display
4	Keypad

2 Safety

2.1 Safety information

2.1.1 Safety information in this operating manual

This operating manual provides important information on the safe operation of the instrument. Read this operating manual thoroughly and make yourself familiar with the instrument before putting it into operation or working with it. The operating manual must be kept in the vicinity of the instrument so you can always find the information you need.

Important safety instructions are highlighted in this operating manual. They are indicated by the warning symbol (triangle) in the left column. The signal word (e.g. "CAUTION") indicates the level of danger:



WARNING

indicates a possibly dangerous situation that can lead to serious (irreversible) injury or death if the safety instruction is not followed.



CAUTION

indicates a possibly dangerous situation that can lead to slight (reversible) injury if the safety instruction is not followed.

Note

indicates a situation where goods might be damaged if the actions mentioned are not taken.

2.1.2 Safety signs on the product

Note all labels, information signs and safety symbols on the product. A warning symbol (triangle) without text refers to safety information in this operating manual.

2.1.3 Further documents providing safety information

The following documents provide additional information, which you should observe for your safety when working with the thermoreactor:

- Analysis specifications for the cell tests
- Safety datasheets for the cell tests

2.2 Safe operation

2.2.1 Authorized use

The authorized use is exclusively the carrying out of reactions for photometric determinations, with the aid of commercial test sets, in round cells with a diameter of 16 ± 0.2 mm. Only the operation and running of the product according to the instructions given in this operating manual is authorized (see chapter 8 TECHNICAL DATA). Any other use is considered unauthorized.

2.2.2 Requirements for safe operation

Note the following points for safe operation:

- The product may only be operated according to the authorized use specified above.
- The product may only be supplied with power by the energy sources mentioned in this operating manual.
- The product may only be operated under the environmental conditions mentioned in this operating manual.
- The round cells to be used including the screw caps must be suitable and tested for the intended application (temperature resistance, chemical stability against the reaction mixture, pressure resistance, tightness).
- The reaction mixture in the round cells must not be inflammable.
- For operation, the cell shafts have to be clean and free of obstacles.
- Round cells may only be inserted and heated with the cap screwed on.
- The instrument may only be opened if this is explicitly described in this operating manual (example: inserting and removing the cells).
- The connection cable and fuses may only be replaced with original WTW replacement parts.

2.2.3 Unauthorized use

The product must not be put into operation if:

- it is visibly damaged (e.g. after being transported)
- it was stored under adverse conditions for a lengthy period of time (storing conditions, see chapter 8 TECHNICAL DATA).

2.3 Personal protective equipment

For your safety, wear the following personal protective equipment to be protected against any (residual) risk while carrying out certain activities:

- Protective goggles and protective clothing with long sleeves as a protection against any splashes of hot and corrosive liquids
- Chemical-resistant gloves as a protection against contact with possibly noxious substances
- Heat protection gloves to touch hot parts
- Safety shoes for protection against heavy falling objects

Activity	Protective goggles	Protective clothing with long sleeves	Chemical resistant gloves	Heat protection gloves	Safety shoes
Transport, positioning					✓
Inserting or removing cells or the external temperature sensor	✓	✓		✓ (if the instrument is hot)	
Cleaning after a cell has broken or its content has been spilled	✓	✓	✓		

3 Commissioning

3.1 General handling instructions

Always protect the instrument against conditions that might damage its mechanical and electronic components. Observe the following points especially:

- For operation and storage, the temperature and air humidity must be within the limits specified in chapter 8 TECHNICAL DATA.
- The following impacts on the instrument have to be avoided in any situation:
 - Extreme dust, moisture and wetness
 - Intensive light and heat
 - Corrosive or solvent-containing vapors.
- Any spilled or splattered liquid and broken glass in the thermoblock have to be removed immediately (see section 6.4).
- The protection cover should always be closed when the instrument is not operating.
- The thermoblock must be empty while the instrument is being transported.

3.2 Scope of delivery

- Thermoreactor CR 3200
- Power cable
- Operating manual

3.3 Unpacking and positioning



CAUTION

The instrument is quite heavy. Therefore, there is a risk of injury for the lower extremities if it falls down. Wear safety shoes during the unpacking and positioning of the instrument.



CAUTION

Fire hazard! The thermoreactor may only be operated on a surface of nonflammable material. The ventilation slots in the bottom and rear panel of the instrument must always be free. Air circulation in the area of the ventilation slots must not be impeded.

Note

Please make sure to keep the original packing including the inner packages so the instrument will be optimally protected against strong impacts if it has to be transported. The original packing is also required for the appropriate return transport if the instrument has to be repaired. Please note that the warranty does not cover any damage caused by inappropriate transport.

Note

If the thermoreactor was transported from a cold environment to a warm environment, the formation of condensate can lead to the faulty functioning of the instrument. Wait until the thermoreactor has adapted to the changed environmental conditions before putting it back into operation.

Setting up the thermoreactor

- | | |
|---|--|
| 1 | Place the thermoreactor firmly on a flat, nonflammable surface. |
| 2 | Make sure that there is enough space between the thermoreactor and other instruments or devices that are heat sensitive. |

3.4 Initial commissioning

Adjusting the line voltage

- | | |
|---|---|
| 3 | Check whether the arrow on the back of the housing points to the line voltage stated on the fuse holder that is provided by the power supply system (115 or 230 V). |
|---|---|

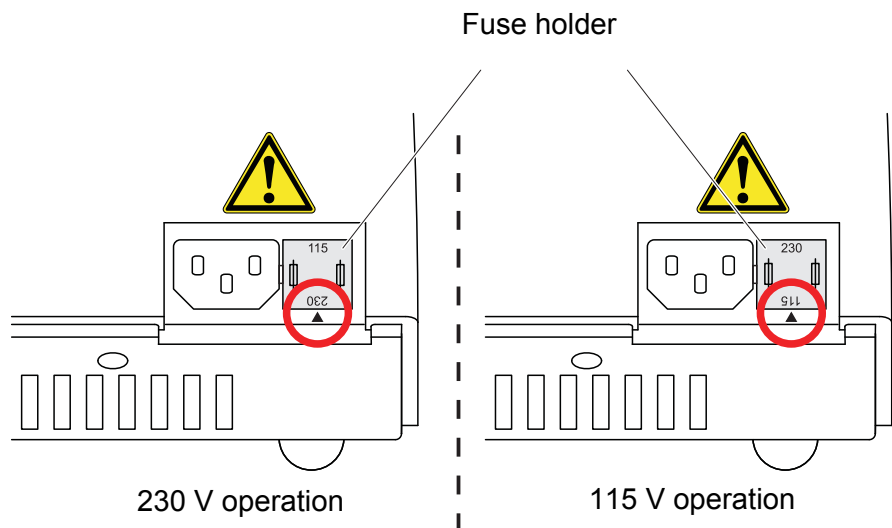

- | | |
|---|---|
| 4 | If the wrong line voltage is set, perform steps 5 to 7. |
| 5 | Pull out the fuse holder. |

- 6 Turn the fuse holder so that the arrow on the housing points to the line voltage (115 or 230 V) provided by the power supply system.
- 7 Push the fusion holder completely in.

Connecting the power cable

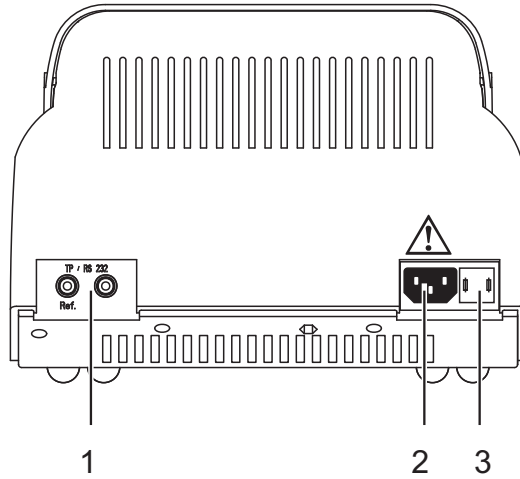

- 1 Connection for temperature sensor or PC
- 2 Connection for power cable
- 3 Fusion holder



CAUTION

Each time before commissioning, check the outside of the power cable for intactness. A damaged cable must be removed and replaced by an original power cable. Original power cables are listed in chapter 9 REPLACEMENT PARTS AND ACCESSORIES / OPTIONS. Exclusively use original power cables suitable for the country-specific power supply system. Do not use any line adapters (fire hazard).



If the power cable is not suitable for the power supply system of your country, please contact your supplier for an exchange.

- 8 Connect the power cable to the socket 2 on the thermoreactor.
- 9 Connect the power cable to an easily available power socket. The thermoreactor is now in the Standby mode. The display shows the name of the instrument.

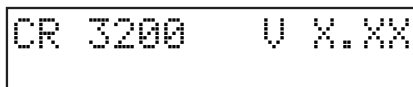

The thermoreactor is ready for operation.

4 Basic principles of operation

This chapter provides you with basic information on how to operate the thermoreactor.

4.1 Operating and display elements

Using the six keys of the keypad (see section 4.1.1) you control the thermoreactor.

Temperature values, available temperature programs or settings can be viewed in the display (see section 4.1.2).

Their color (red or green) and their state (flashing or illuminated) show the current operating state of the thermoreactor (see section 4.1.3).

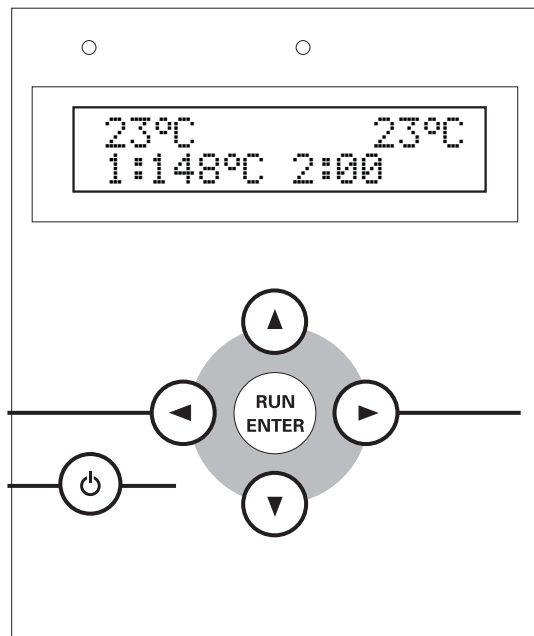

4.1.1 Keys

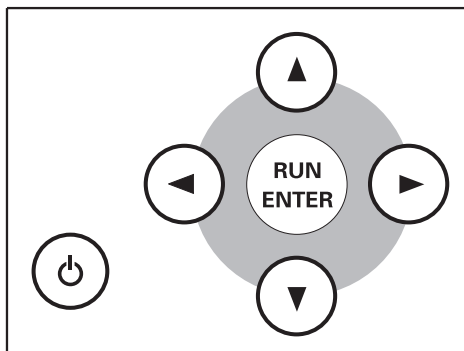

Key	Meaning
	On/off switch
	<ul style="list-style-type: none"> ● Making or confirming a selection or <ul style="list-style-type: none"> ● Starting the timer for the reaction time (active temperature program).
	Keep depressed and simultaneously press : Changing to the <i>SETUP</i> menu from the Standby mode
	<ul style="list-style-type: none"> ● Changing between the temperature setting and the reaction time setting (in the <i>SETUP</i> menu) or <ul style="list-style-type: none"> ● Canceling the active temperature program
	<ul style="list-style-type: none"> ● Selecting the temperature program (program selection) or <ul style="list-style-type: none"> ● Changing settings and switching between settings (<i>SETUP</i>) ● Starting the scrolling through settings by keeping the key depressed

4.1.2 Display

Example: Program selection

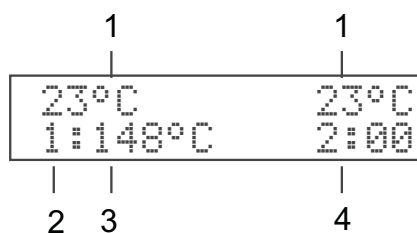

1	Temperature in the thermoblock
2	Number of the temperature program
3	Specified temperature
4	Reaction time in hours and minutes

4.1.3 Control lamps (LEDs)

The control lamps above the operating panel are assigned to the thermoblock and indicate the current operating state.

LED	flashes	is illuminated
green		Program selection
red	active temperature program: heating period or cooling period	active temperature program: reaction temperature reached
red and green	active temperature program: program canceling selected	

If the control lamps are off the thermoreactor is in the Standby mode.

4.2 Operating modes

The thermoreactor has three operating modes:

- Standby

The display shows the model and version number of the thermoreactor.

With the key combination  and  you move to the *SETUP* menu. There you can:

- Edit the 8 temperature programs and the temperature test program (setting the temperature and reaction time for the programs 9 to 16 and *T*, see section 5.5.1)
- Setting the display contrast (*CONTRAST:0* to 9, see section 5.4.1)

- Activating a manual confirmation before the timer for the reaction time is started (*START TIMER:MAN.* or *AUTO*, see section 5.4.2)
- Program selection
After switching on with  the display shows the current temperature values for the thermoblock.
The second display line shows the temperature programs and the temperature test program to be selected if a reaction time of at least one minute has been set (see section 5.5.1). The control lamps above the display for the selected thermoblock light up green.
- Active temperature program
The display shows the current temperature value for the thermoblock . The control lamps above the display light up or flash red.

5 Operation

5.1 Inserting and removing the reaction cells



WARNING

Always wear protective goggles and protective clothing with long sleeves as a protection against any splashes of hot and corrosive liquids. When dealing with cell tests always follow the relevant safety data sheets and analysis specifications.



CAUTION

Very hot - burn hazard. Wear heat protection gloves to remove the cells when they are hot. Place hot cells in a cell rack.

1	Open the protective cover.
2	Insert or remove the reaction cells from the cell shafts without jamming.
3	Close the protection cover.





When cold reaction cells are inserted in the preheated thermoblock it can temporarily cool down by approx. 3 °C.

5.2 Starting a temperature program

1	Switch on the thermoreactor with  .
---	--

```

23°C          23°C
1:148°C  2:00
  
```

2	Select a temperature program with   . You can select from 8 predefined temperature programs and a temperature test program (see section 5.6.1).
---	--

```

23°C          23°C
4:120°C  2:00
  
```

3	Start the displayed temperature program with  . The control lamps of the thermoblock flash red. The nominal reaction time (in hours and minutes) appears on the display.
---	---



The reaction temperature is reached when the temperature in the thermoblock is in a range of ± 1 °C around the adjusted temperature for two minutes constantly. The control lamps of the thermoblock will then light up red.

Operation with automatic timer

If the start of the timer for the reaction time has been set to automatic in the *SETUP* menu (*START TIMER:AUTO* see section 5.4.2), the reaction time automatically starts after the reaction temperature has been achieved. The reaction temperature is kept constant during the reaction time.

After the reaction time has expired the control lamps flash red.

The temperature program is finished.

The thermoreactor is in the program selection mode.

As soon as the thermoblock has cooled down to under 50 °C, the control lamps switch themselves off.

Operation with manual timer

If the start of the timer for the reaction time has been set to manual in the *SETUP* menu (*START TIMER:MAN.* see section 5.4.2), an S is displayed in front of the nominal reaction time. With this setting the thermoreactor controls the temperature until the timer for the reaction time is started by pressing .

100°C	100°C
S2:00	

- 4 Start the timer for the reaction time with . The S in front of the reaction time disappears.

The reaction temperature is kept constant during the reaction time. The control lamps of the thermoblock light up red.

After the reaction time has expired the control lamps flash red.

An audio signal sounds in addition.

- 5 Confirm the end of the reaction time for the thermoblock with .

The temperature program is finished.



The audio signal is finished.

The thermoreactor is in the program selection mode.



As soon as the thermoblock has cooled down to under 50 °C, the control lamps switch themselves off.

5.3 Stopping a temperature program

You can terminate a running program at any time.

- 1 Using  , terminate the running temperature program. The control lamp for the thermoblock flashes red/green. The safety query *STOP?* is displayed.

54°C STOP?	54°C
---------------	------

- 2 Using  confirm the safety query *STOP?*
The temperature program is finished.
The control lamps of the thermoblock will then light up green.
or:
Using  , exit *STOP?*.
The query *STOP?* disappears from the display. The temperature program is continued.



While *STOP?* is displayed the temperature program goes on running. As soon as a section of the temperature program is finished (e.g. after the end of the heating period or after the end of the reaction time), the *STOP?* display is overwritten.

5.4 Temperature test program

With the temperature test program you can check the temperature regulation and heating time for a thermoblock with the aid of the external temperature sensor TFK CR (see chapter 9 REPLACEMENT PARTS AND ACCESSORIES / OPTIONS). While the temperature test program is active, the display shows the current temperature of the thermoblock and at the same time the measured temperature value of the external temperature sensor.

The thermoreactor functions correctly if the temperature of the external temperature sensor does not deviate from the nominal temperature value by more than 2 °C.

If the deviations from the nominal value are greater, further measures can be necessary (see chapter 7 WHAT TO DO IF...).





The external temperature sensor has the same accuracy as the internal temperature sensor.

5.4.1 Starting the temperature test program



For the temperature test program to be started, the thermoreactor must have cooled down completely. All other temperature programs are blocked while the temperature test program is running.

- 1 Connect the external temperature sensor to the socket at the thermoreactor (see chapter 3 COMMISSIONING).
- 2 Insert the external temperature sensor in a cell shaft.
- 3 Switch on the thermoreactor with .
- 4 Using  , select the temperature test program *T*.

```

23°C      23°C
T: 80°C   0:30
    
```

- 5 Using , start the temperature test program *T*.

```

100,3°C   0:30
100,5°C   0:10
    
```

The first display line shows the nominal measuring time and the temperature of the thermoblock. The second display line shows the temperature of the external temperature sensor. After the nominal temperature has been reached, the measuring time is counted down in the second display line.

During the temperature regulation phase, the thermoreactor saves the measured temperature values of the external temperature sensor in a test report every 60 seconds.

As soon as the temperature test is finished, "*PRINT*" appears on the display.

```

100.0°C   0:30
          PRINT
    
```

You can now output the measuring data of the temperature test to a PC or printer.

You have the following options now:

- To connect the thermoreactor with a PC and transmit the test report to a terminal program (see section 5.5.2).
- To connect the thermoreactor with a printer and download the test report to the printer (see section 5.5.2).
- Using , exit the temperature test program.

The test report in the thermoreactor is erased in any case at the end.



CAUTION

Very hot - burn hazard. Wear heat protection gloves to remove the temperature sensor when it is hot. Place the hot temperature sensor on a heat resistant surface.

5.4.2 Outputting the test report to an external printer/PC

To transmit the temperature test report to a printer or PC, a printer cable or PC cable is required (see chapter 9 REPLACEMENT PARTS AND ACCESSORIES / OPTIONS).

You can record the test report with the aid of a terminal program on the PC side.

Generally, a terminal program serves to establish a connection to a meter at a data interface and to communicate with the meter via a console on the display. A terminal program usually offers the possibility to save the contents of the console in a text file or print it. If the terminal program is connected to the thermoreactor, it can receive the temperature test report and display it on the console.

Terminal programs are available by different manufacturers for different operating systems. If necessary, contact your administrator.

More detailed information can be taken from the user information of the terminal program.

Sample report

```
CR 3200 V.X.XX
Tref = 148 C
1: Tblock = 147.5 C
2: Tblock = 147.6 C
3: Tblock = 147.7 C
. . .
. . .
```

Downloading the test report

Precondition:

The temperature test is finished and *PRINT* is displayed (see page 5-22).

- 1 Disconnect the external temperature sensor from the thermoreactor.



When connecting the PC or printer cable observe the cable poling. Data transmission is possible with the correct poling only.

Socket assignment



1 Ref
2 TxD

- 2 Connect the thermoreactor to the PC or printer. (Cable see chapter 9 REPLACEMENT PARTS AND ACCESSORIES / OPTIONS). To do so:
 - plug the reference plug (unmarked) in the "Ref" socket (1).
 - plug the signal plug (marked by a red ring) in the socket (2).
- 3 Start the terminal program on the PC.
- 4 Set the following transmission data in the terminal program:

Baud rate	4800
Handshake	none
Parity	none
Data bits	8
Stop bits	1
Record	none

5 Start the data transmission with . After the transmission is finished the test report is deleted in the thermoreactor.

5.5 Settings





5.5.1 Editing a temperature program

The temperature programs 1 to 8 are installed permanently and cannot be changed.

The temperature programs 9 to 16 and the temperature test program can be edited according to individual requirements.





For the temperature test program, a TFK CR external temperature sensor is required (available as an accessory, see chapter 9 REPLACEMENT PARTS AND ACCESSORIES / OPTIONS).

- 1 Switch to the Standby mode.
- 2 Keep the  key depressed while pressing  to switch to the *SETUP* menu. *SETUP* and, in the second line, an editable parameter are displayed.
- 3 Usign  , select a temperature program no. 9 to 16 or the temperature test program.



- 4 Using , edit the selected temperature program. The two parameters temperature and time are displayed. The editing is marked on the display by *. The selected parameter is marked by an arrow < or >.





- 5 Using  , change the parameter (e.g. temperature).

- 6 | Using ◀ ▶, switch to the other parameter.



```

SETUP      *
T: 80°C > 0:30
  
```

- | | |
|---|--|
| 7 | Using ▲ ▼, change the parameter (e.g. reaction time). |
| 8 | Using  , confirm the changes.
The marking on the display (*) disappears. |
| 9 | Using  leave the <i>SETUP</i> menu.
The changes are stored.
The thermoreactor is switched on (operation mode: program selection). |

5.5.2 Setting the display contrast

The display contrast can be set in 10 steps.

- | | |
|---|---|
| 1 | Switch to the Standby mode. |
| 2 | Keep the  key depressed while pressing  to switch to the <i>SETUP</i> menu.
<i>SETUP</i> and, in the second line, an editable parameter are displayed. |
| 3 | Using ▲ ▼, select <i>CONTRAST</i> . |



```

SETUP
CONTRAST:5
  
```

- | | |
|---|--|
| 4 | Using  edit the contrast setting.
The editing is marked on the display by *. |
|---|--|

```

SETUP      *
CONTRAST:5
  
```





- | | |
|---|--|
| 5 | Using ▲ ▼, set the contrast from 0 to 9. |
| 6 | Using  , confirm the changes.
The marking on the display (*) disappears. |
| 7 | Using  leave the <i>SETUP</i> menu.
The changes are stored.
The thermoreactor is switched on (operation mode: program selection). |

5.5.3 Setting the timer for the reaction time

After the start of a temperature program the thermoblock starts heating up. Depending on the setting, the timer for the reaction time starts automatically after the reaction temperature has been reached or only after confirmation by keypressing.

With the setting *START TIMER:AUTO* the timer for the reaction time starts immediately after the reaction temperature has been reached.





With the setting *START TIMER:MAN.* the timer for the reaction time only starts after confirmation by keypressing.

1	Switch to the Standby mode.
2	Keep the  key depressed while pressing  to switch to the <i>SETUP</i> menu. <i>SETUP</i> and, in the second line, an editable parameter or a temperature program are displayed.
3	Using   , select <i>START TIMER</i> .

```

SETUP
START TIMER:MAN.

```

4	Set the start of the timer for the reaction time with  . The editing is marked on the display by *.
5	Using   , select <i>MAN.</i> or <i>AUTO</i> .
6	Using  , confirm the changes. The marking on the display (*) disappears.
7	Using  leave the <i>SETUP</i> menu. The changes are stored. The thermoreactor is switched on (operation mode: program selection).

6 Maintenance, cleaning, disposal

6.1 Maintenance

The thermoreactor CR 3200 is maintenance free. Check the ventilation slots on the rear panel of the instrument at regular intervals. Remove any accumulations of dust in the slots, e.g. with a vacuum cleaner. Do not use compressed air!



CAUTION

Fire hazard! The ventilation slots in the bottom and rear panel of the instrument must always be free. Air circulation in the area of the ventilation slots must not be impeded.

6.2 Exchanging the fuses



CAUTION

A defective fuse may only be replaced by an original fuse with UL approval. The original fuse is listed in chapter 9 REPLACEMENT PARTS AND ACCESSORIES / OPTIONS.

- 1 Disconnect the line power cable from the thermoreactor.

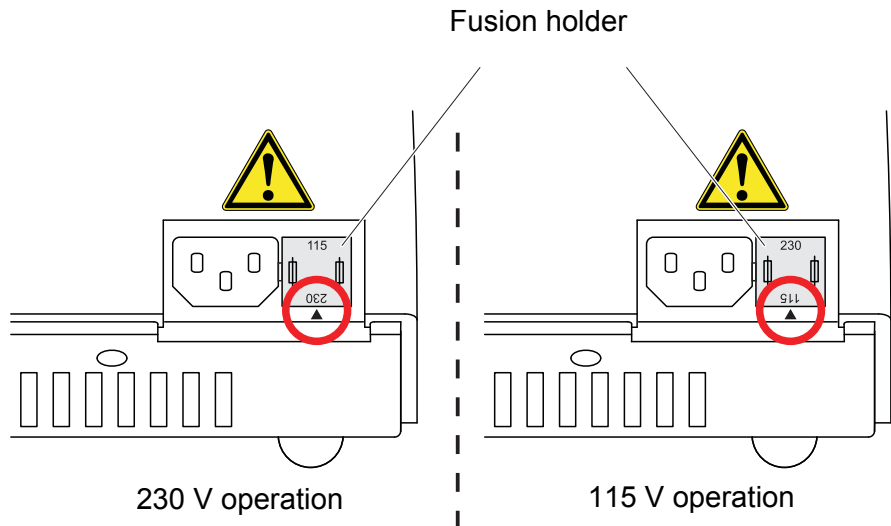

- 2 Pull out the fuse holder.
- 3 Exchange defective fuses.
- 4 Turn the fuse holder so that the arrow on the housing points to the line voltage (115 or 230 V) provided by the power supply system.
- 5 Push the fusion holder completely in.

6.3 Cleaning the enclosure

Wipe the thermoreactor with a damp cloth.

Note

The housing is made of synthetic material. Thus, avoid contact with acetone or detergents that contain solvents. Remove any splashes immediately.

6.4 Cleaning the thermoblocks of spilled cell contents

If liquid penetrated a thermoblock (e.g. from a leaking or broken cell), clean the thermoblock as follows:



WARNING

Cells can contain poisonous or corrosive substances. If the content was released, heed the safety datasheet of the cell test and take the required protective measures (protective goggles, protective gloves etc.).



CAUTION

Danger of cuts due to broken glass. Remove any broken glass with a pair of tweezers completely. Do not pick any broken glass with your bare fingers.



CAUTION

Burn hazard on the hot thermoblock. Prior to cleaning, allow the thermoreactor to cool down.

1	Switch off the thermoreactor and disconnect the power plug.
2	Allow the thermoreactor to cool down.
3	Unscrew the cover plate on top of the thermoblocks.
4	Remove any broken glass with a pair of tweezers <u>completely</u> .
5	Clean the cover plate, block surfaces and borings with a damp cloth.
6	Screw on the cover plate again.



CAUTION

Fire hazard. If any flammable detergents are used, completely remove all detergent residues prior to the next commissioning.



Discoloration that remains on the thermoblock and cover plate does not affect the functioning of the thermoreactor.

6.5 Disposal

Dispose of the thermoreactor as electronic waste at an appropriate collection point. It is illegal to dispose of the thermoreactor in household refuse.

7 What to do if...

There is nothing on the display	Cause The power supply is interrupted	Remedy <ul style="list-style-type: none"> – Check power cable and connections – Exchange the fuses – Have repaired by service department
Bars are displayed instead of the temperature (-°C)	Cause With an active temperature test program: The signal of the external temperature sensor was not recognized <hr/> In the program selection mode: Internal temperature sensor defective	Remedy <ul style="list-style-type: none"> – Connect the temperature sensor – Have repaired by service department <hr/> – Have repaired by service department
Temperature deviation during temperature test program	Cause Bad thermal contact between the external temperature sensor and the thermoblock	Remedy <ul style="list-style-type: none"> – Use original accessories only – Close the protection cover during the temperature test – Contact the service department
Cell contents spilled / thermoblock contaminated	Cause e.g. leaking cell	Remedy <ul style="list-style-type: none"> – see section 6.4

8 Technical Data

Reactor type	Dry temperature control device with safety cover
Cell shafts	2 x 12 cell shafts for reaction cells, diameter: 16 ± 0.2 mm
Reaction time setting	20 min, 30 min, 60 min, 120 min (via fixed programs) 8 freely adjustable programs: 0...180 min
Temperature setting	100 °C, 120 °C, 148 °C, 150 °C via fixed programs and 8 freely adjustable programs: Room temperature ...170 °C
Controlling accuracy	± 1 °C ± 1 digit
Temperature stability	± 0.5 K
Overtemperature protection	190 °C ± 5 °C
Heating time (with empty thermoblock) from 25 °C to	100 °C approx. 5 min 120 °C approx. 7 min 148 °C approx. 10 min
Temperature of the enclosure at an environmental temperature of 25 °C	< 30 °C with a block temperature of 148 °C
Housing materials	Upper part: PC/ABS Blend Lower part: PA66 Protective cover: PC Cover plate: PBT GF30
Dimensions	D x W x H: 312 x 255 x 185 mm
Weight:	4 kg
Output	unidirectional RS232 interface with 2 banana sockets for: <ul style="list-style-type: none"> ● External temperature sensor or <ul style="list-style-type: none"> ● Printer ● PC
Power supply	115/230 VAC 50/60 Hz, allowed voltage tolerance: ± 15 % Maximum power consumption: 560 W Fuses 2 x 6.3 AT
Protective class	I according to DIN VDE 0700 part 1

Overvoltage category	II
Protection	IP 20 according to EN 60529
Ambient temperature	Storage -25 °C to +65 °C Operation +5 °C to +40 °C
Climatic class	2 according to VDI/VDE 3540 Relative humidity: Yearly mean: < 75 % 30 days /year: 95 % Other days: 85 % Light dew: yes Site altitude: max. 5000 m above sea level
EMC	EN 61326-1 FCC 47 CFR Part 15
Test certificates	cETLus, CE
Safety standards	EN 61010-1 EN 61010-2-010 UL 61010-1 CAN/CSA C22.2#61010-1 CAN/CSA C22.2#61010-2-010

9 Replacement parts and accessories / options

Replacement parts

Designation	Accessory
REP3-3000 1005	Original fuse set (2 items; 6.3 A) with UL approval
REP3-3000 1006	Original power cable, type EU
REP3-3000 1007	Original power cable, type UK
REP3-3000 1008	Original power cable, type USA/Canada
REP3-3000 1009	Original power cable, type Australia

Accessories/Options

Designation	Accessory
TFK CR	External temperature sensor for the monitoring of test equipment of the CR 3200 and CR 4200 thermoreactors
AK CR/PC	PC cable for thermoreactors CR 3200 and CR 4200
AK CR/P	Printer cable for thermoreactors CR 3200 and CR 4200

10 Index

C

Commissioning	10
Components of the thermoreactor	6
Control lamps (LEDs)	15

F

Fuses	22
-------------	----

K

Keys	14
------------	----

M

Maintenance	22
-------------------	----

O

Operating and display elements	13
Operating modes	15

P

Program selection	16
-------------------------	----

S

Safety	7
Sample display	15
Scope of delivery	10
Setting the display contrast	19
Standby	15
Starting a temperature program	17

T

Temperature program active	16
Trouble shooting	25

W

What to do if... ..	25
---------------------	----

What can Xylem do for you?

We're a global team unified in a common purpose: creating innovative solutions to meet our world's water needs. Developing new technologies that will improve the way water is used, conserved, and re-used in the future is central to our work. We move, treat, analyze, and return water to the environment, and we help people use water efficiently, in their homes, buildings, factories and farms. In more than 150 countries, we have strong, long-standing relationships with customers who know us for our powerful combination of leading product brands and applications expertise, backed by a legacy of innovation.

For more information on how Xylem can help you, go to xyleminc.com.



Service address:

Xylem Analytics Germany
Sales GmbH & Co. KG
WTW
Dr.-Karl-Slevogt-Str. 1
82362 Weilheim
Germany

Tel.: +49 881 183-325
Fax: +49 881 183-414
E-Mail wtw.rma@xyleminc.com
Internet: www.WTW.com



Xylem Analytics Germany GmbH
Dr.-Karl-Slevogt-Str. 1
82362 Weilheim
Germany