

## QUICK START GUIDE

ba75977e04 11/2018

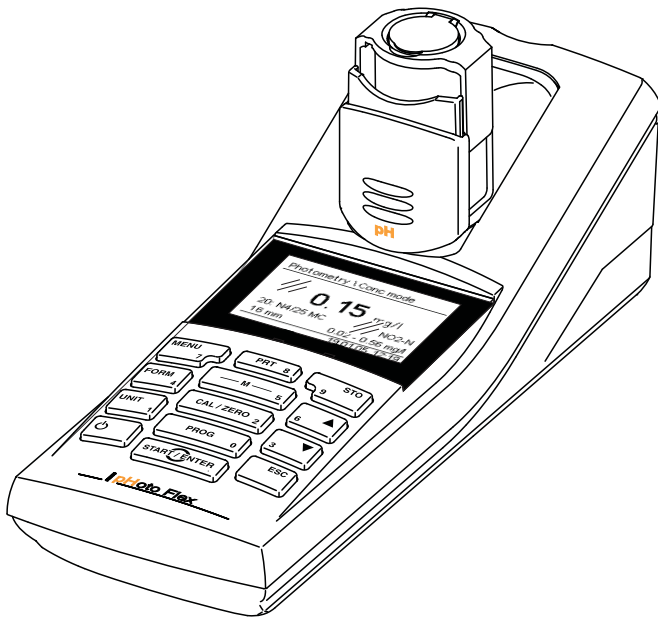

# photoFlex<sup>®</sup> pH

LED FILTER PHOTOMETER WITH INTEGRATED pH FUNCTION



a xylem brand

**Copyright**

© 2018 Xylem Analytics Germany GmbH  
Printed in Germany.

## Contents

<b>Safety</b> .....	<b>4</b>
<b>Display and socket field</b> .....	<b>4</b>
<b>Power supply</b> .....	<b>5</b>
<b>General operating principles</b> .....	<b>5</b>
<b>Initial commissioning</b> .....	<b>9</b>
<b>Operation</b> .....	<b>9</b>
Inserting a cell .....	9
Photometry .....	12
pH value / ORP voltage .....	14
<b>Maintenance, cleaning.</b> .....	<b>16</b>
<b>What to do if...</b> .....	<b>18</b>
General errors .....	18
Photometry .....	18
pH value / ORP voltage .....	19
<b>Technical data</b> .....	<b>21</b>
General data .....	21
Photometry .....	23
pH value / ORP voltage .....	24



Part of the process of consequently improving our products is the continuous further development of the range of photometric tests offered and the meter firmware. All current data for the pHotoFlex® pH can be found on the Internet under [www.WTW.com](http://www.WTW.com):

- Firmware
- Method data
- Analysis specifications
- Operating manual

You can easily transfer new firmware to your instrument with the aid of the AK 540/B cable and a PC. More detailed information can be found in the detailed operating manual on the CD-ROM provided.

## Safety

### Target group

The meter was developed for work in the field and in the laboratory. We assume that, as a result of their professional training and experience, the operators will know the necessary safety precautions to take when handling the chemicals of photometric test sets.

The personnel responsible for the commissioning, operation and maintenance must have the necessary qualifications for this work. If the personnel do not have the required skills they have to be instructed. Furthermore, it must be ensured that the personnel read and completely understand the present operating manual.

### Safety instructions

Important safety instructions are highlighted in this operating manual. They are indicated by the warning symbol (triangle) in the left column. The signal word (e.g. "Caution") indicates the level of danger:



#### CAUTION

indicates a possibly dangerous situation that can lead to slight (reversible) injury if the safety instruction is not followed.

#### NOTE

indicates a possibly dangerous situation where goods might be damaged if the actions mentioned are not taken.

### Safe operation



#### CAUTION

Danger of eye damage by visible and invisible LED radiation. In the cell shaft there are light emitting diodes (LED) of the 1M class. Do not look at the radiation using optical instruments. With normal, authorized use there is no hazard.

## Display and socket field

### Display

The graphic display shows all information of the current measurement in the measured value display. The illumination enables to read the display even in the darkness.

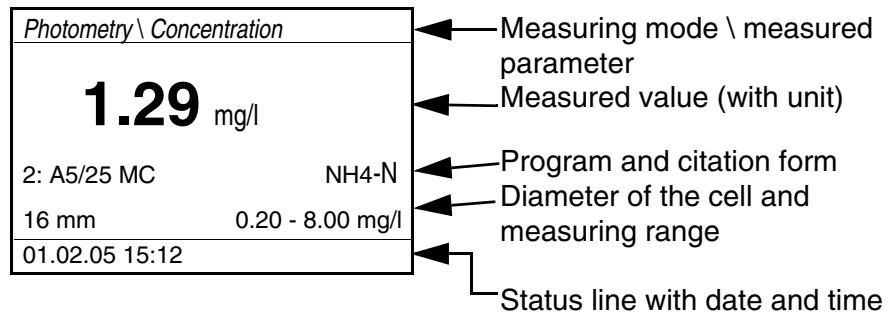

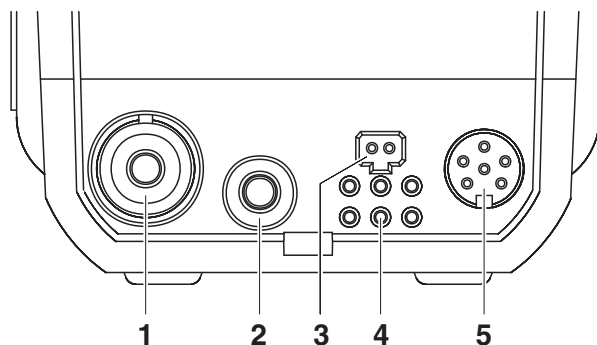
**Socket field****Identifying the connectors**

1	pH electrode
2	pH temperature sensor
3	Power pack (9 V DC, see page 22)
4	Contacts for operation on the LabStation
5	RS232 serial interface

**Power supply**

You can operate the meter either with batteries, rechargeable battery or a power pack.

The *LoBat* display indicator appears when the batteries or rechargeable battery is nearly discharged.

**General operating principles**

This section contains basic information on the operation of the pHotoFlex® pH.

**Operating modes**

- **Measurement**  
The display indicates measurement data in the measured value display
- **Calibration**  
The display indicates a calibration process with calibration information, or a process to carry out a zero adjustment
- **Data transmission**  
The meter transmits measuring datasets or calibration records to the serial interface
- **Configuration**  
The display indicates a menu with further menus, settings and functions

## Keypad



Select the measuring mode

<M> (long keystroke):

- *Photometry*
- *pH & ORP*

Select the measured parameter within a measuring mode

<M> (short keystroke):

- *pH & ORP*: *pH, ORP*
- *Photometry*:

*Concentration, Absorbance, % Transmission*



Start calibration (measuring mode *pH & ORP*)

Start zero adjustment or blank value measurement via the *Photometry \ Adjustment* menu

(measuring mode, *Photometry*)

<CAL/ZERO>



In the *Photometry* measuring mode: Select a program for concentration measurement

<PROG>



Open menus / confirm entries / start measurement

<START/ENTER>



Call up the *Configuration* menu (all settings are made here)

<MENU>



In the *Photometry* measuring mode, measured parameter, *Concentration*:

switch over between available citation forms

<FORM>



In the *Photometry* measuring mode, measured parameter, *Concentration*:

Switch over between available units <UNIT>



Switch the meter on/off

<ON/OFF>





Output display contents to RS232 interface (e.g. print)

<PRT>



Open the *Store* menu: <STO>

Quick storing: 2 x <STO>

 	Highlight menu items or selection / set values <▲>, <▼>
	Switch to the next higher menu level / cancel input <ESC>



Keys with an additional number printed on are assigned doubly. This enables to directly enter numbers in special menus. Thus, you can, for example, conveniently enter the date and time via the number keys.

### Measured value display

In the measured value display, you can

- select a measuring mode with <M> (long pressure)
- select a measured parameter in the active measuring mode (e. g. pH <-> mV) with <M> (short pressure)
- open the menu with <MENU>
- switch to the higher *Start* menu with <ESC>.

### Menus and dialogs

The menus for settings and dialogs in procedures contain further submenus. The selection is made with the <▲> <▼> keys. The current selection is highlighted as white text on a black background.

- Menus  
The name of the menu is displayed at the upper edge of the frame. Menus are opened by confirming with <START/ENTER>. Example:

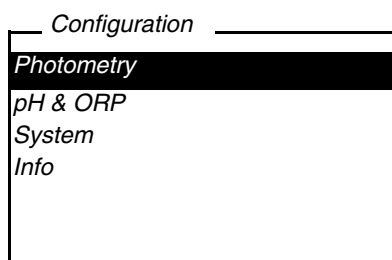

- Settings  
Settings are indicated by a colon. The current setting is displayed on the right-hand side. With <START/ENTER>, the selection of the possible settings is opened. Subsequently, the setting can be changed with <▲> <▼> and <START/ENTER>. Example:

System	
Language:	English
Beep:	Off
Illumination:	On
Contrast:	48 %
Temperature unit:	°C
Switchoff time:	30 min

● **Functions**

Functions are designated by the name of the function. They are immediately carried out by confirming with **<START/ENTER>**.  
 Example: display the *Calibration record* function (in the *pH & ORP / Calibration* menu).

pH & ORP	
<b>Calibration record</b>	
Cal. type:	AutoCal
TEC	
Calibration interval:	007 d
Unit for slope:	mV/pH
■ 2.00 4.01 7.00 10.01	

● **Messages**

Information or operating instructions are indicated by the ■ symbol. They cannot be selected.  
 Example:

pH & ORP	
■ Buffer recognition TEC	
■ Immerse sensor in buffer 1	
<b>Set temperature: 25 °C</b>	
Continue	

← The ■ indicates info texts, e.g. messages, notes or instructions



## Initial commissioning

### Switching on the meter

Press the <ON/OFF> key.

For a few seconds, the *Start* menu appears with a selection of the measuring modes. The measuring mode last selected is highlighted.

After a few seconds, the meter automatically switches to the measuring mode and measured parameter used last.

### Setting the language

The English language is set on delivery. Set a different language as follows:

1	Open the <i>Configuration</i> menu with the <MENU> key.
2	Open the <i>Configuration / System / Language</i> menu with the <▲> <▼> and <START/ENTER> keys.
3	Select the required language with the <▲> <▼> keys and confirm with <START/ENTER>.
4	Quit the menu with the <M> key.

### Setting the date and time

The date and time are set in the menu, *Configuration / System / Continue ... / Date/time*.

## Operation

### Inserting a cell

To be able to insert cells in the pHotoFlex® pH, the cell shaft has to be prepared to take in a cell.

1	<p>Push the dust cover (1) upward. The cell shaft for 28 mm cells is open.</p> <ul style="list-style-type: none"> <li>● Insert a 28 mm cell (see below)</li> <li>● Insert a 16 mm cell (see page 10)</li> </ul>
---	---

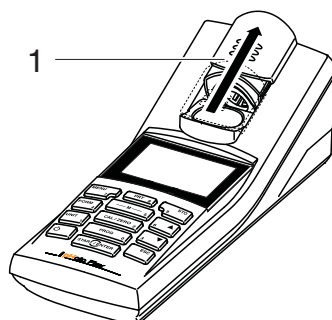

**Inserting a 28 mm cell**

- 2 Insert the cell so that it is positioned on the bottom of the cell shaft.  
The cell is ready to be measured.



**Inserting a 16 mm cell**

- 1 Put the fold-out cell shaft (2) in an upright position until it locks into place.

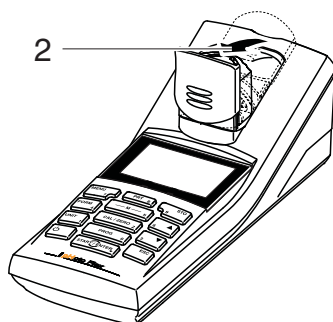

- 2 Pull up the height adapter (3).  
The cell shaft is extended.

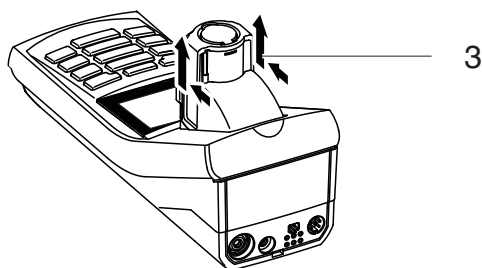

- 3 Open the external light cover (4) of the cell shaft.

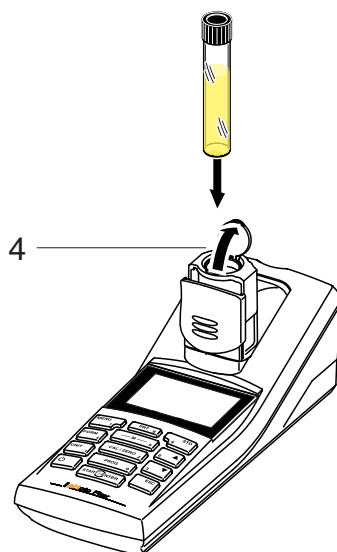

- |   |  |
|---|--|
| 4 | Insert the 16 mm cell (marking points forward) so that it is positioned on the bottom of the cell shaft. |
| 5 | Close the external light cover (4).<br>The cell is ready to be measured.                                 |

### Photometry

#### Measuring the concentration

- 1 Press the **<M>** key (long pressure) repeatedly until the *Photometry* measuring mode is selected.
- 2 Press the **<M>** key (short pressure) repeatedly until the measured parameter, *Concentration* is selected.

First concentration measurement with the pHotoFlex® pH

Second and all further concentration measurements

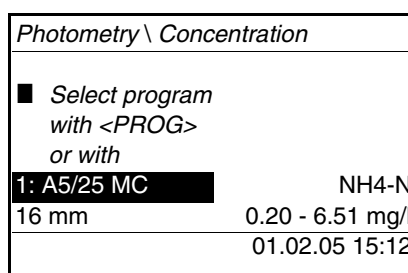
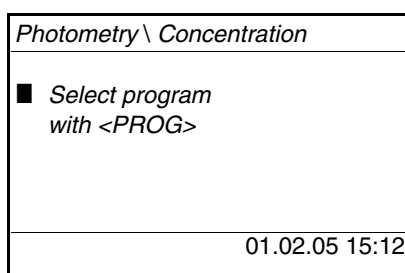

From the second concentration measurement, the data of the program last used is automatically displayed here.

With **<▲>** **<▼>** you can quickly switch between the ten programs last used.

- 3 Open the *Program number* display with **<PROG>**, enter the required program number with the number keys and confirm with **<START/ENTER>**.  
or (from the second concentration measurement):  
Select a program out of the last ten programs with **<▲>** **<▼>**.  
The program data is displayed.



If a program number is selected that requires a measured blank value, the menu automatically guides to the blank value measurement.

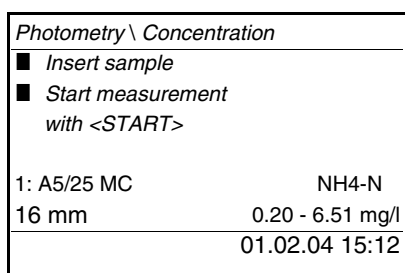

- 4 Insert the cell (see page 9).

- 5 Start the measurement with **<START/ENTER>**. Measurement is started. The result is displayed.

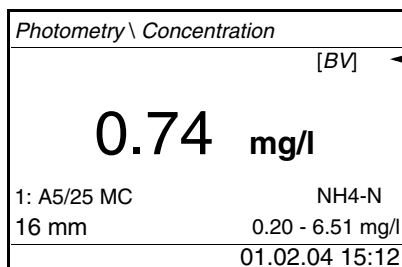

← A blank value measured by the user is used

**Blank value  
(reagent blank value)**

A blank value is required for every concentration measurement. For some programs (methods) for concentration measurement, the blank values are already stored in the meter. For all other programs, the blank value has to be determined separately before the first measurement.



You will find more information on blank values in the photometry analysis manual. A table with the programs and required blank values can be found in the analysis specifications.

**Zero adjustment**

The zero adjustment, i. e. measuring and storing the absorbance of a cell filled with water, is necessary after the meter is switched on.

Additionally, we recommend to carry out a zero adjustment if the ambient temperature has changed.

Only perform the zero adjustment against distilled water in an optically perfect cell. The zero adjustment must be performed separately for each cell type.

**Zero adjustment / blank value measurement**

1	Press the <b>&lt;M&gt;</b> key (long pressure) repeatedly until the <i>Photometry</i> measuring mode is selected.
2	Press the <b>&lt;M&gt;</b> key (short pressure) repeatedly until the measured parameter, <i>Concentration</i> is selected.
3	Press the <b>&lt;CAL/ZERO&gt;</b> key. The menu for adjustment measurements opens up.

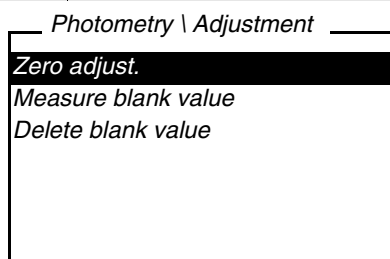

- 4 Using <▲> <▼> and <START/ENTER>, select and start the *Zero adjust.* or *Measure blank value* function.  
The menu-guided blank value measurement or zero adjustment starts.  
Follow the instructions on the display.

### pH value / ORP voltage

- 1 Connect a suitable pH or ORP electrode to the pHotoFlex® pH.
- 2 Press the <M> key (long pressure) repeatedly until the *pH & ORP* measuring mode is selected.

### Measuring the pH value

- 1 Immerse the pH electrode in the test sample.

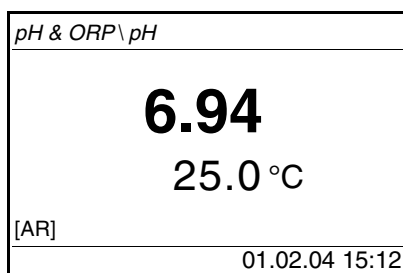

- 2 Press the <M> key (short pressure) repeatedly until the measured parameter, *pH* is selected.

**Measuring the ORP**

- 1 Submerge the ORP electrode in the sample.

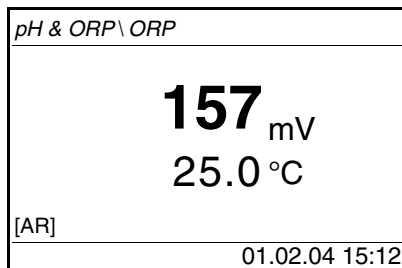

- 2 Press the <M> key (short pressure) repeatedly until the measured parameter, pH is selected.

**Calibration**

- 1 Press the <M> key (long pressure) repeatedly until the pH measuring mode is selected.
- 2 Press the <CAL/ZERO> key.
   
The menu-guided calibration begins.
   
Follow the instructions on the display.

**Calibrate**

- at regular intervals
- after connecting another electrode
- when the sensor symbol flashes:
  - after the calibration interval has expired
  - after voltage interruption (e.g. empty batteries, empty rechargeable battery)

## Maintenance, cleaning

### Maintenance

The meter is almost maintenance-free.

The only maintenance task is replacing the batteries or rechargeable battery.

#### NOTE

Make sure the poles of the batteries are the right way round. The ± signs on the batteries must correspond to the ± signs in the battery compartment.

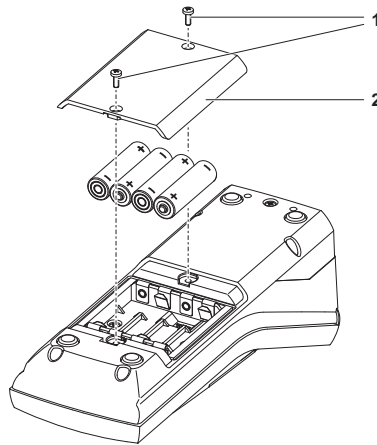

1	<p>Open the battery compartment:</p> <ul style="list-style-type: none"> <li>– Unscrew the two screws (1) on the underside of the meter,</li> <li>– Remove the lid of the battery compartment (2).</li> </ul>
2	<p>If necessary, take four old batteries out of the battery compartment.</p>
3	<p>Insert four batteries (3) in the battery compartment.</p>
4	<p>Close the battery compartment and fix it with the screws.</p>



Dispose of used batteries according to the local regulations of your country.

End users within the European Union are obligated to return used batteries (even ecologically compatible ones) to a collection point set up for recycling purposes.

Batteries are marked with the crossed-out waste container symbol. Therefore, they may not be disposed with the domestic waste.

### Cleaning

Occasionally wipe the outside of the meter with a damp, lint-free cloth. Disinfect the housing with isopropanol as required.

#### NOTE

The housing components are made out of synthetic materials



(polyurethane, ABS and PMMA). Thus, avoid contact with acetone and similar detergents that contain solvents. Remove any splashes immediately.

### Cleaning the cell shaft

If liquid is in the cell shaft (e.g. due to a spilled cell), clean the cell shaft as follows:



#### CAUTION

**Cells can contain poisonous or corrosive substances. If the content is released follow the danger warnings on the cell. If necessary, take corresponding protective measures (protective goggles, protective gloves etc.).**

- |   |   |
|---|---|
| 1 | Switch the pHotoFlex® pH off and pull out the power plug. |
| 2 | Rinse the cell shaft with distilled water.                |

### Cleaning the cells

Cells have to be clean, dry, and free of fingerprints and scratches. Therefore, clean them regularly:

- |   |   |
|---|---|
| 1 | Clean the cells inside and out with hydrochloric acid or laboratory soap.                               |
| 2 | Rinse out several times with distilled water.   |
| 3 | Let them dry in the air.  |
| 4 | Only hold the cells by the top or by the light protection cap so that the optical path is not impaired. |
| 5 | Before measuring, clean the cell with the enclosed cleaning cloth.                                      |



Scratches in the glass change the optical characteristics of the cell and falsify the measured value. For this reason, never use scratched cells!

## What to do if...

### General errors

#### Display, *LoBat*

Cause	Remedy
<ul style="list-style-type: none"> <li>– The batteries or rechargeable battery are largely depleted</li> </ul>	<ul style="list-style-type: none"> <li>– Insert new batteries</li> <li>– Charge the rechargeable battery</li> </ul>

#### Instrument does not react to keystroke

Cause	Remedy
<ul style="list-style-type: none"> <li>– Software error</li> <li>– Operating condition undefined or EMC load unallowed</li> </ul>	<ul style="list-style-type: none"> <li>– Processor reset: Press the &lt;START/ENTER&gt; and &lt;PRT&gt; key simultaneously.</li> </ul>

#### RS232 interface does not react

Cause	Remedy
<ul style="list-style-type: none"> <li>– Software error</li> <li>– Operating condition undefined or EMC load unallowed</li> </ul>	<ul style="list-style-type: none"> <li>– Processor reset: Press the &lt;START/ENTER&gt; and &lt;PRT&gt; key simultaneously.</li> </ul>

#### Error message, *Error 0, 8, 16, 16384*

Cause	Remedy
<ul style="list-style-type: none"> <li>– Instrument error</li> </ul>	<ul style="list-style-type: none"> <li>– Repeat measurement</li> <li>– Meter defective, send meter for repair and quote the error number</li> </ul>

### Photometry

#### Measuring range undercut or exceeded

Cause	Remedy
<ul style="list-style-type: none"> <li>– Program not suitable</li> </ul>	<ul style="list-style-type: none"> <li>– Select program with suitable measuring range</li> <li>– Dilute the sample</li> </ul>

**Obviously incorrect measured values**

Cause	Remedy
– Measurement disturbed by external light	– Close the external light cover.
– Cell not correctly inserted	– Insert the cell so that it is positioned on the bottom of the cell shaft.
– Cell contaminated	– Clean the cell
– Cell shaft contaminated	– Clean the cell shaft
– Dilution set incorrectly	– Set the dilution
– Selected program unsuitable	– Select other program
– Zero measurement incorrect	– Perform zero measurement
– Blank value incorrect	– Remeasure the blank value

**pH value / ORP voltage****Measuring range exceeded or undercut**

Cause	Remedy
<i>Electrode:</i>	
– Air bubble in front of the junction	– Remove air bubble
– Air in the junction	– Extract air or moisten junction
– Gel electrolyte dried out	– Replace electrode
<i>Test sample:</i>	
– The pH value lies outside the measuring range	– not possible

**Measured value display  
----  
(calibration error)**

Cause	Remedy
<i>Electrode:</i>	
– Junction contaminated	– Clean junction
– Membrane contaminated	– Clean membrane
– Moisture in the plug	– Dry plug

Cause	Remedy
– Not enough electrolyte	– Top up electrolyte
– Electrode obsolete	– Replace electrode
– Electrode broken	– Replace electrode
– Socket damp	– Dry socket

*Calibration procedure:*

– Incorrect solution temperature (without temperature sensor)	– Set up correct temperature
– Incorrect buffer solutions	– Select buffer solutions suitable for the calibration procedure
– Buffer solutions too old	– Use only once. Note the shelf life

**No stable measured value**

Cause	Remedy
<i>pH electrode:</i>	
– Junction contaminated	– Clean junction
– Membrane contaminated	– Clean membrane
<i>Test sample:</i>	
– pH value not stable	– Measure with air excluded if necessary
– Temperature not stable	– Temper if necessary
<i>Electrode + test sample:</i>	
– Conductivity too low (e.g. in ultrapure water)	– Use suitable electrode
– Temperature too high	– Use suitable electrode
– Organic liquids	– Use suitable electrode

**Obviously incorrect measured values**

Cause	Remedy
<i>pH electrode:</i>	
– Not connected	– Connect electrode

Cause	Remedy
– Cable broken	– Replace cable or electrode
– pH electrode unsuitable	– Use suitable electrode
– Temperature difference between buffer and test sample too high	– Adjust temperature of buffer or sample solutions
– Measurement procedure not suitable	– Follow special procedure

**Sensor symbol flashes**

Cause	Remedy
– Calibration interval expired	– Recalibrate the measuring system

**Technical data****General data**

<b>Dimensions</b>	approx. 236 x 86 x 117 mm	
<b>Weight</b>	approx. 0.6 kg (without batteries)	
<b>Mechanical structure</b>	Type of protection	IP 67
<b>Electrical safety</b>	Protective class	III
<b>Test certificates</b>	CE, FCC	
<b>Ambient conditions</b>	Storage	- 25 °C ... + 65 °C
	Operation	0 °C ... + 50 °C
	Climatic class	2
<b>Allowable relative humidity</b>	Yearly mean:	75 %
	30 days /year:	95 %
	other days:	85 %

<b>Power supply</b>	Batteries	4 x 1.5 V, type AA
	Operating time with battery operation	approx. 5000 measurements
	Rechargeable battery (optional)	5 x 1.2 V nickel metal hydride (NiMH), type AAA
	Power pack Charging device (optional)	FRIWO FW7555M/09, 15.1432.500-00 Friwo Part. No. 1883259 ----- RiHuiDa RHD20W090150 ----- Input: 100 ... 240 V ~ / 50 ... 60 Hz / 400 mA Output: 9 V = / 1,5 A Connection max. overvoltage category II Primary plugs contained in the scope of delivery: Euro, US, UK and Australian.
<b>Serial interface</b>	Connection of the cable AK 540/B or AK 540/S	
	Baud rate	adjustable: 1200, 2400, 4800, 9600, 19200 Baud
	Type	RS232
	Data bits	8
	Stop bits	2
	Parity	None
	Handshake	RTS/CTS
	Cable length	Max. 15 m
<b>Guidelines and norms used</b>	EMC	EC guideline 89/336/EEC EN 61326-1/A3:2003 FCC Class A
	Instrument safety	EC guideline 73/23/EEC EN 61010-1 :2001
	Climatic class	VDI/VDE 3540
	IP protection	EN 60529:1991

### **FCC Class A Equipment Statement**

*Note:* This equipment has been tested and found to comply with the limits for a Class A digital device, pursuant to Part 15 of the FCC Rules. These limits are designed to provide reasonable protection against harmful interference when the equipment is operated in a commercial environment. This equipment generates, uses, and can radiate radio frequency energy and, if not installed and used in accordance with the instruction manual, may cause harmful interference to radio communications. Operation of this equipment in a residential area is likely to cause harmful interference in which case the user will be required to correct the interference at his own expense.

### **Photometry**

<b>Optical measuring principle</b>	LED photometer with filter	
<b>Interference filter</b>	436 nm, 517 nm, 557 nm, 594 nm, 610 nm, 690 nm	
<b>Photometric reproducibility</b>	Accuracy:	± 2 nm
<b>Photometric resolution</b>	0.005 or better	
<b>Warm-up time</b>	0.001	
<b>Measuring time</b>	none	
<b>Measured parameters</b>	approx. 2s	
<b>Measuring range</b>	Concentration (method dependent, selectable display form), absorbance, transmission	
<b>User-defined programs</b>	Absorbance:	-0.200 ... +2.000
<b>Resolution</b>	Transmission:	1 ... 150 %
<b>Transmission</b>	100	
	1.00 ... 9.99	0.01 %
	10.0 ... 150	0.1 %

**pH value / ORP voltage**

**Measuring ranges, resolution**

Variable	Measuring range	Resolution
pH	- 2.00 ... + 16.00	0.01
U [mV]	- 1000 ... + 1000	1
T [°C]	- 5.0 ... + 100.0	0.1
T [°F]	- 23.0 ... + 212.0	0.1

**Manual temperature input**

Variable	Range	Increment
T <sub>manual</sub> [°C]	- 20 ... + 100	1

**Accuracy (± 1 digit)**

Variable	Accuracy	Temperature of the test sample
pH *	± 0.01	+ 15 °C ... + 35 °C
U [mV]	± 1	+ 15 °C ... + 35 °C
T [°C]	± 0.3	0 °C ... + 55 °C
T [°F]	± 0.54	0 °C ... + 55 °C

\* when measuring in a range of ± 2 pH around a calibration point





# What can Xylem do for you?

We're a global team unified in a common purpose: creating innovative solutions to meet our world's water needs. Developing new technologies that will improve the way water is used, conserved, and re-used in the future is central to our work. We move, treat, analyze, and return water to the environment, and we help people use water efficiently, in their homes, buildings, factories and farms. In more than 150 countries, we have strong, long-standing relationships with customers who know us for our powerful combination of leading product brands and applications expertise, backed by a legacy of innovation.

**For more information on how Xylem can help you, go to [xyleminc.com](http://xyleminc.com).**



**Service address:**

Xylem Analytics Germany  
Sales GmbH & Co. KG  
WTW  
Dr.-Karl-Slevogt-Str. 1  
82362 Weilheim  
Germany

Tel.: +49 881 183-325  
Fax: +49 881 183-414  
E-Mail [wtw.rma@xyleminc.com](mailto:wtw.rma@xyleminc.com)  
Internet: [www.WTW.com](http://www.WTW.com)



Xylem Analytics Germany GmbH  
Dr.-Karl-Slevogt-Str. 1  
82362 Weilheim  
Germany