



Multi 3620 IDS

DIGITAL METER FOR IDS SENSORS



a xylem brand

Copyright © 2017 Xylem Analytics Germany GmbH
Printed in Germany.

Multi 3620 IDS - Contents

1	Overview	7
1.1	MeterMulti 3620 IDS	7
1.2	Sensors	8
1.2.1	IDS sensors	8
1.2.2	Wireless operation of IDS sensors	8
1.2.3	IDS adapter for analog sensors	9
1.2.4	Automatic sensor recognition	9
2	Safety	10
2.1	Safety information	10
2.1.1	Safety information in the operating manual	10
2.1.2	Safety signs on the meter	10
2.1.3	Further documents providing safety information	10
2.2	Safe operation	11
2.2.1	Authorized use	11
2.2.2	Requirements for safe operation	11
2.2.3	Unauthorized use	11
3	Commissioning	12
3.1	Scope of delivery	12
3.2	Power supply	12
3.3	Initial commissioning	12
3.3.1	Inserting the rechargeable batteries	13
3.3.2	Connecting the power pack / charging the batteries	13
3.3.3	Switching on the meter	14
3.3.4	Setting the date and time	15
4	Operation	16
4.1	General operating principles	16
4.1.1	Keypad	16
4.1.2	Display	17
4.1.3	Status information	17
4.1.4	Connectors	18
4.1.5	Channel display	18
4.1.6	Sensor info.	19
4.1.7	Display of several sensors in the measuring mode	20
4.2	Switching on the meter	21
4.3	Switching off the meter	21
4.4	Login with user name	22
4.5	Navigation	23
4.5.1	Operating modes	23
4.5.2	Measured value display	24

4.5.3	Menus and dialogs	24
4.5.4	Navigation example 1: Setting the language	26
4.5.5	Example 2 on navigation: Setting the date and time	27
5	pH value.	29
5.1	Measuring	29
5.1.1	Measuring the pH value	29
5.1.2	Measuring the temperature	30
5.2	pH calibration.	31
5.2.1	Why calibrate?	31
5.2.2	When do you have to calibrate?	31
5.2.3	Automatic calibration (AutoCal)	31
5.2.4	Manual calibration (ConCal)	34
5.2.5	Calibration points	38
5.2.6	Calibration data	38
5.3	Continuous measurement control (CMC function)	40
5.4	QSC function (sensor quality control)	41
6	ORP	45
6.1	Measuring	45
6.1.1	Measuring the ORP	45
6.1.2	Measuring the temperature	46
6.2	ORP calibration	47
7	Dissolved oxygen	48
7.1	Measuring	48
7.1.1	Measuring D.O.	48
7.1.2	Measuring the temperature	50
7.2	FDO [®] check procedure (check of the FDO [®] 925).	50
7.2.1	Why should you check the sensor?	50
7.2.2	When should you check the sensor?	50
7.2.3	Carrying out the FDO [®] check procedure	51
7.2.4	Evaluation.	52
7.3	Calibration	52
7.3.1	Why calibrate?	52
7.3.2	When to calibrate?	52
7.3.3	Calibration procedure	53
7.3.4	Calibration in water vapor-saturated air	53
7.3.5	Calibration data	54
8	Conductivity	56
8.1	Measuring	56
8.1.1	Measuring the conductivity	56
8.1.2	Measuring the temperature	58
8.2	Temperature compensation.	58
8.3	Calibration	59
8.3.1	Why calibrate?	59
8.3.2	When to calibrate?	59
8.3.3	Determining the cell constant (calibration in control standard)	59
8.3.4	Calibration data	60

9	Turbidity measurement (VisoTurb® 900-P)	63
9.1	Measuring	63
9.1.1	Measuring the turbidity	63
9.2	Calibration	65
9.2.1	Why calibrate?	65
9.2.2	When to calibrate?	65
9.2.3	Calibration standards	66
9.2.4	Carry out calibration	66
9.2.5	Calibration data	68
10	Settings	70
10.1	pH measurement settings	70
10.1.1	Settings for pH measurements	70
10.1.2	Buffer sets for calibration	71
10.1.3	Calibration interval	73
10.2	ORP measurement settings	74
10.2.1	Settings for ORP measurements	74
10.3	D.O. measurement settings	74
10.3.1	Settings for D.O. sensors	74
10.4	Cond measurement settings	76
10.4.1	Settings for IDS conductivity sensors	76
10.5	Turb measurement settings	78
10.5.1	Settings for turbidity sensors	78
10.6	Sensor-independent settings	79
10.6.1	<i>System</i>	79
10.6.2	<i>Data storage</i>	80
10.6.3	<i>Automatic Stability control</i>	81
10.6.4	Automatic switch-off function	81
10.6.5	Display illumination	81
10.7	Reset	81
10.7.1	Resetting the measurement settings	82
10.7.2	Resetting the system settings	84
11	Data memory	85
11.1	Manual storage	85
11.2	Automatic data storage at intervals	85
11.3	Measurement data memory	88
11.3.1	Editing the measurement data memory	88
11.3.2	Erasing the measurement data memory	89
11.3.3	Measurement dataset	89
12	Transmitting data	91
12.1	Saving data to a USB memory device	91
12.2	Transmitting data to a USB printer	91
12.3	Transmitting data to a PC	93
12.4	MultiLab Importer	95
13	Maintenance, cleaning, disposal	96
13.1	Maintenance	96
13.1.1	General maintenance activities	96

13.1.2	Replacing the rechargeable batteries	96
13.2	Cleaning	97
13.3	Packing	97
13.4	Disposal	97
14	What to do if...	98
14.1	General information	98
14.2	pH	99
14.3	Dissolved oxygen	101
14.4	Conductivity	101
14.5	Turbidity	102
15	Technical data.	103
15.1	General data	103
15.2	Measuring ranges, resolution, accuracy	104
16	Appendix: Firmware update	105
16.1	Firmware update for the meter Multi 3620 IDS	105
16.2	Firmware-Update for IDS Sensors	106
17	Glossary	107
18	Index	109

1 Overview

1.1 MeterMulti 3620 IDS

The compact, digital precision meter Multi 3620 IDS enables you to carry out pH measurements, ORP measurements, conductivity measurements, dissolved oxygen (D.O.) measurements and turbidity measurements quickly and reliably.

The Multi 3620 IDS provides the maximum degree of operating comfort, reliability and measuring certainty for all applications.

The Multi 3620 IDS supports you in your work with the following functions:

- proven calibration procedures
- automatic stability control (AR)
- automatic sensor recognition
- CMC (continuous measurement control)
- QSC (sensor quality control).

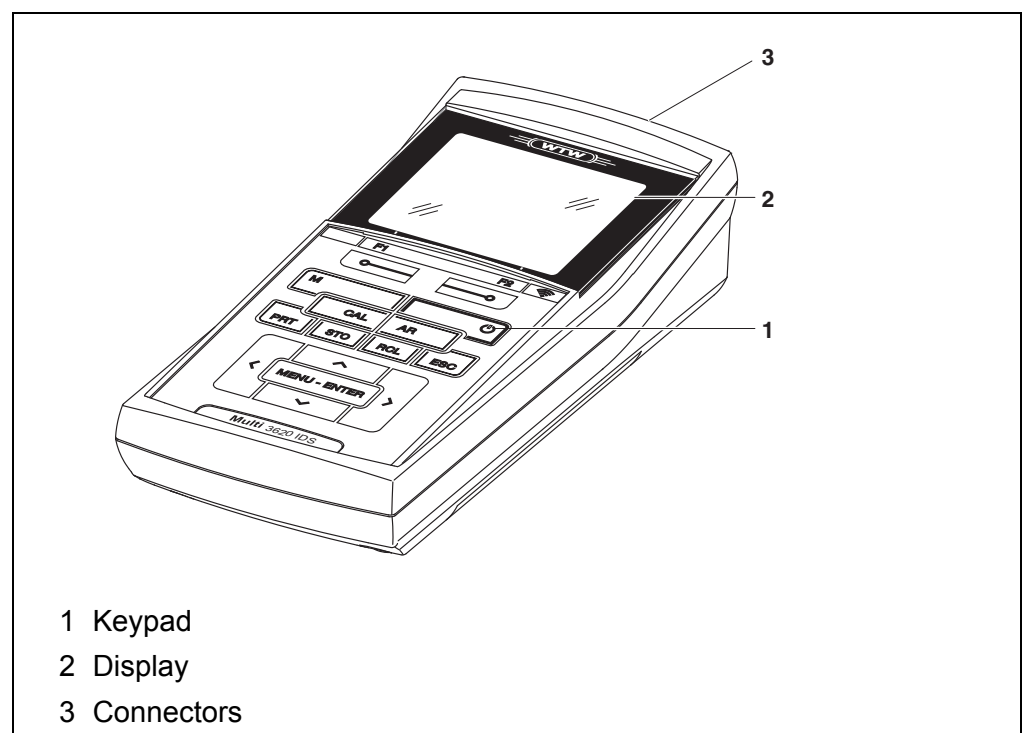

1.2 Sensors

1.2.1 IDS sensors

IDS sensors

- support the automatic sensor recognition
- show only the settings relevant to the specific sensor in the setting menu
- process signals in the sensor digitally so that precise and interference-free measurements are enabled even with long cables
- facilitate to assign a sensor to a measured parameter with differently colored couplings
- have quick-lock couplings with which to fix the sensors to the meter.



Information on available IDS sensors is given on the Internet.

Sensor data from IDS sensors

IDS sensors transmit the following sensor data to the meter:

- SENSOR ID
 - Sensor name
 - Sensor series number
- Calibration data
- Measurement settings

The calibration data are updated in the IDS sensor after each calibration procedure. A message is displayed while the data are being updated in the sensor.



In the measured value display, you can display the sensor name and series number of the selected sensor with the [Info] softkey. You can then display further sensor data stored in the sensor with the [More] softkey (see section 4.1.6 SENSOR INFO).

1.2.2 Wireless operation of IDS sensors

With the aid of the adapters in the IDS WLM System, IDS sensors with plug head connectors (variant P) can be wirelessly connected to your Multi 3620 IDS.



Further information on the wireless operation of IDS sensors:

- Web resources
- Operating manual of the IDS WLM System.

1.2.3 IDS adapter for analog sensors

With the aid of an IDS adapter, you can also operate analog sensors on the Multi 3620 IDS. The combination of the IDS adapter and analog sensor behaves like an IDS sensor.



Information on available IDS adapters is given on the Internet. Detailed information on the IDS adapter is given in the operating manual of the adapter.

1.2.4 Automatic sensor recognition

The automatic sensor recognition for IDS sensors allows

- to operate an IDS sensor with different meters without recalibrating
- to operate different IDS sensors at one meter without recalibration
- to assign measurement data to an IDS sensor
 - Measurement datasets are always stored and output with the sensor name and sensor series number.
- to assign calibration data to an IDS sensor
 - Calibration data and calibration history are always stored and output with the sensor name and sensor series number.
- to activate the correct cell constant for conductivity sensors automatically
- to hide menus automatically that do not concern this sensor

To be able to use the automatic sensor recognition, a meter that supports the automatic sensor recognition (e.g. Multi 3620 IDS) and a digital IDS sensor are required.

In digital IDS sensors, sensor data are stored that clearly identify the sensor. The sensor data are automatically taken over by the meter.

2 Safety

2.1 Safety information

2.1.1 Safety information in the operating manual

This operating manual provides important information on the safe operation of the meter. Read this operating manual thoroughly and make yourself familiar with the meter before putting it into operation or working with it. The operating manual must be kept in the vicinity of the meter so you can always find the information you need.

Important safety instructions are highlighted in this operating manual. They are indicated by the warning symbol (triangle) in the left column. The signal word (e.g. "CAUTION") indicates the level of danger:



WARNING

indicates a possibly dangerous situation that can lead to serious (irreversible) injury or death if the safety instruction is not followed.



CAUTION

indicates a possibly dangerous situation that can lead to slight (reversible) injury if the safety instruction is not followed.

NOTE

indicates a possibly dangerous situation where goods might be damaged if the actions mentioned are not taken.

2.1.2 Safety signs on the meter

Note all labels, information signs and safety symbols on the meter and in the battery compartment. A warning symbol (triangle) without text refers to safety information in this operating manual.

2.1.3 Further documents providing safety information

The following documents provide additional information, which you should observe for your safety when working with the measuring system:

- Operating manuals of sensors and other accessories
- Safety datasheets of calibration or maintenance accessories (such as buffer solutions, electrolyte solutions, etc.)

2.2 Safe operation

2.2.1 Authorized use

The authorized use of the meter consists exclusively of the measurement of the pH, ORP, conductivity and dissolved oxygen in a laboratory environment.

Only the operation and running of the meter according to the instructions and technical specifications given in this operating manual is authorized (see section 15 TECHNICAL DATA, page 103).

Any other use is considered unauthorized.

2.2.2 Requirements for safe operation

Note the following points for safe operation:

- The meter may only be operated according to the authorized use specified above.
- The meter may only be supplied with power by the energy sources mentioned in this operating manual.
- The meter may only be operated under the environmental conditions mentioned in this operating manual.
- The meter may only be opened if this is explicitly described in this operating manual (example: Inserting the batteries).

2.2.3 Unauthorized use

The meter must not be put into operation if:

- it is visibly damaged (e.g. after being transported)
- it was stored under adverse conditions for a lengthy period of time (storing conditions, see section 15 TECHNICAL DATA, page 103).

3 Commissioning

3.1 Scope of delivery

- MeterMulti 3620 IDS
- 4 NiMH rechargeable batteries 1.2 V Mignon type AA
- USB cable (A plug on mini B plug)
- Power pack
- Short instructions
- Detailed operating manual (4 languages)
- CD-ROM with
 - USB drivers
 - detailed operating manual
 - Software MultiLab Importer

3.2 Power supply

The Multi 3620 IDS is supplied with power in the following ways:

- Battery operation with NiMh rechargeable batteries
- Mains operation with the supplied power pack.
The NiMh batteries are automatically charged while the power pack is connected.
- USB operation via a connected USB-B cable.
The NiMh batteries are not charged

3.3 Initial commissioning

Perform the following activities:

- Insert the batteries and charge them
- Connect the power pack (mains operation / battery charging)
- Switch on the meter
- Set the date and time

3.3.1 Inserting the rechargeable batteries

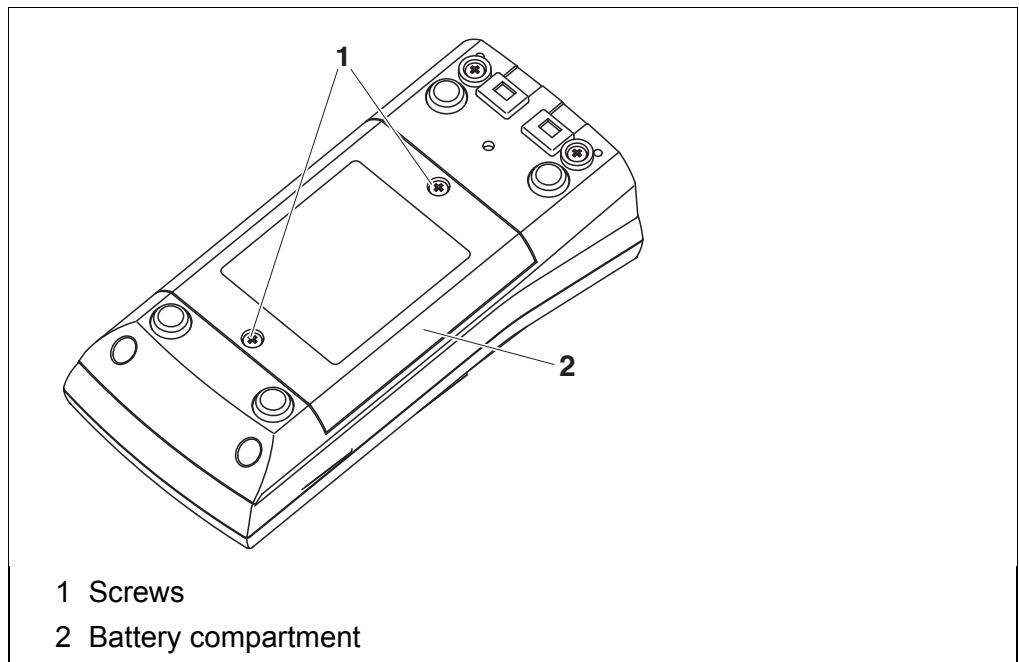

- 1 Unscrew the two screws (1) on the underside of the meter.
- 2 Open the battery compartment (2) on the underside of the meter.



CAUTION

Make sure that the poles of the rechargeable batteries are positioned correctly.
The \pm signs on the batteries must correspond to the \pm signs in the battery compartment.

- 3 Place four rechargeable batteries (type Mignon AA) in the battery compartment.
- 4 Close the battery compartment (2) and tighten the screws (1).

3.3.2 Connecting the power pack / charging the batteries



CAUTION

Use original power packs only (see section 15.1).

The line voltage at the operating site must lie within the input voltage range of the original power pack (see section 15.1).

**CAUTION**



The batteries in the battery compartment are automatically charged when the power pack is connected.

Make sure that only NiMH rechargeable batteries are in the battery compartment. The charging process is optimized for NiMH batteries. Other battery types can cause damage during the charging process.

Make sure that the ambient temperature is not more than 40 °C (104 °F) when the power pack is connected.

- 1 Connect the plug of the power pack to the socket for the power pack on the Multi 3620 IDS.
- 2 Connect the original power pack to an easily accessible power outlet.
- 3 Charge the batteries completely prior to putting the meter into operation for the first time.
The charging process takes approx. 24 hours.

**Operating condition
of the batteries**

Symbol	Explanation
	Line power operation with charge function Batteries are automatically charged in the background
	Battery operation Batteries fully charged
	Battery operation Batteries almost empty

3.3.3 Switching on the meter

- 1 Press the **<On/Off>** key.
The meter performs a self-test.
The display shows the manufacturer's logo while the self-test is being performed.
- 2 Connect the sensor.
The meter switches to the measuring mode (measured value display).



The meter has an energy saving feature to avoid unnecessary power consumption during battery operation. The energy saving feature switches off the meter during battery operation if no key is pressed during the adjusted interval. (How to set the switch-off interval, see section 10.6). The switch-off interval of the energy saving feature is not active when the meter is supplied with power via the power pack or the USB-B cable.

3.3.4 Setting the date and time

3 See section 4.5.5

4 Operation

4.1 General operating principles

4.1.1 Keypad

In this operating manual, keys are indicated by brackets <.> .

The key symbol (e.g. <ENTER>) generally indicates a short keystroke (under 2 sec) in this operating manual. A long keystroke (approx. 2 sec) is indicated by the underscore behind the key symbol (e.g. <ENTER_>).





<F1>: <F2>:	Softkeys providing situation dependent functions, e.g.: <F1>/[Info]: View information on a sensor
<On/Off>: <On/Off_>:	Switches the meter on or off
<M>:	Selects the measured parameter
<CAL>: <CAL_>:	Calls up the calibration procedure Displays the calibration data
<AR>	Freezes the measured value (HOLD function) Switches the AutoRead measurement on or off
<STO>: <STO_>:	Saves a measured value manually Opens the menu for the automatic save function
<RCL>: <RCL_>:	Displays the manually stored measured values Displays the automatically stored measured values
<▲><▼>: <◀><▶>:	Menu control, navigation
<ENTER>: <ENTER_>:	Opens the menu for measurement settings / Confirms entries Opens the menu for system settings
<PRT> <PRT_>	Outputs stored data to the interface Outputs displayed data to the interface at intervals
<ESC>:	Cancels an action



4.1.2 Display

Example (pH):

1 Status information (meter)
 2 Status information (sensor)
 3 Measured value
 4 Measured parameter
 5 Continuous measurement control (CMC function)
 6 Channel display: Plug position of the sensor
 7 Sensor symbol (calibration evaluation, calibration interval)
 8 Measured temperature (with unit)
 9 Softkeys and date + time

4.1.3 Status information

AutoCal e.g. TEC	Calibration with automatic buffer recognition, e.g. with the buffer set: Technical buffers
ConCal	Calibration with any buffers
Error	An error occurred during calibration
AR	Stability control (AutoRead) is active
HOLD	Measured value is frozen (<AR> key)
	Batteries are almost empty
	Mains operation
	Mains operation with charge function Batteries are automatically charged in the background.
	Data are automatically output to the USB-B interface at intervals

	Data are output to the USB-A interface (USB flash drive)
	Data are output to the USB-A interface (USB printer). If there is a USB-B connection at the same time (e.g. to a PC), the data are output to the USB-B interface only.
	Power supply via the USB-B interface Batteries are not being charged

4.1.4 Connectors

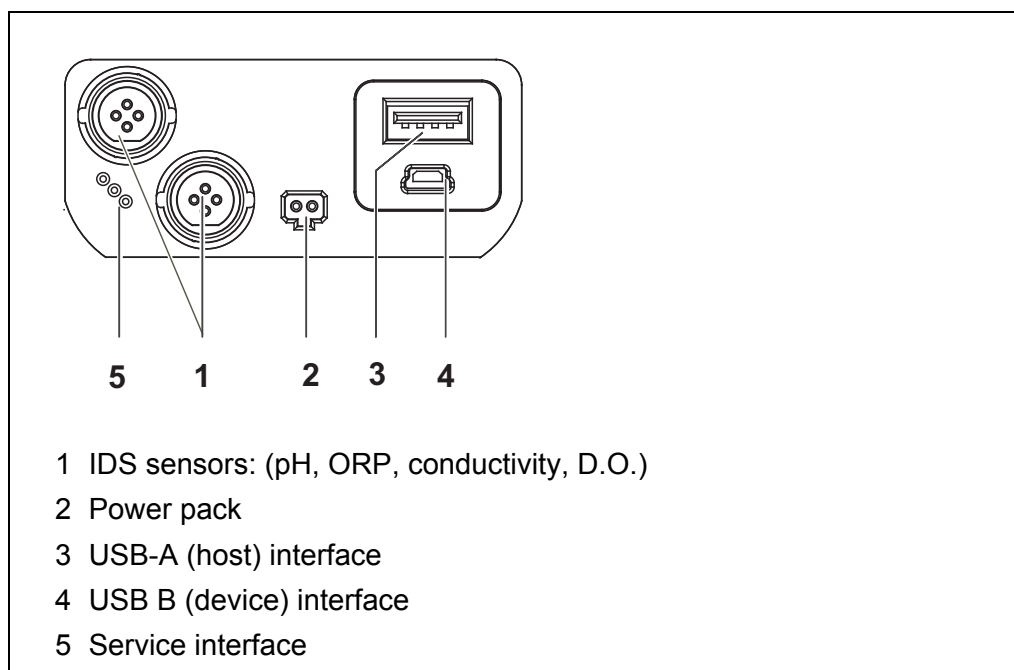

CAUTION

Only connect sensors to the meter that cannot return any volt-ages or currents that are not allowed (> SELV and > current circuit with current limiting).
 WTW IDS sensors and IDS adapters meet these requirements.

4.1.5 Channel display

The Multi 3620 IDS administers the sensors connected and displays which sensor is plugged to which connection.

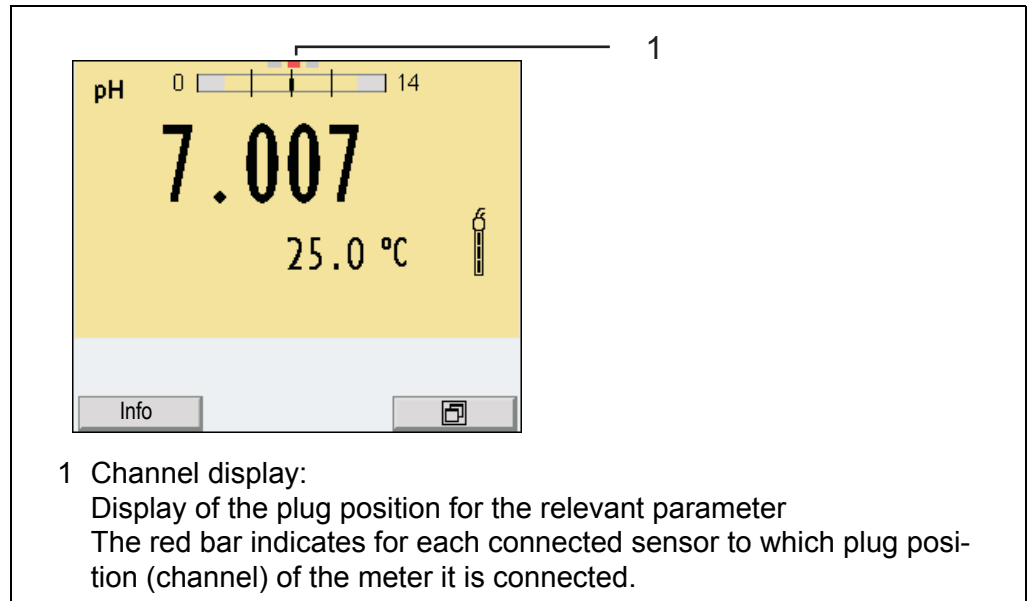

4.1.6 Sensor info

You can display the current sensor data and sensor settings of a connected sensor at any time. The sensor data are available in the measured value display with the [*Info*] softkey.

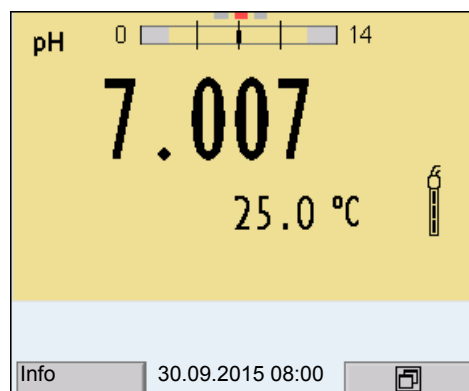

- 1 In the measured value display:
 Display the sensor data (sensor name, series number) with [*Info*].

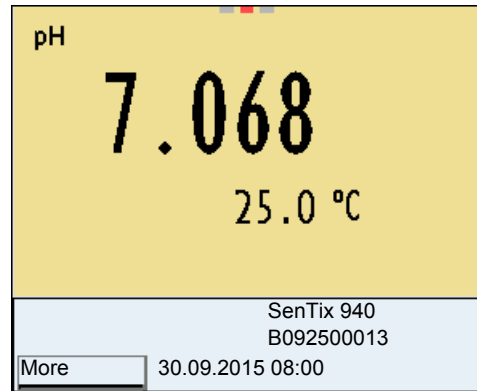

2 Display further sensor data (settings) with [More].

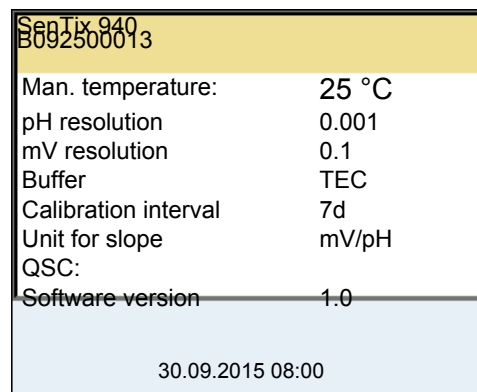

4.1.7 Display of several sensors in the measuring mode

The measured values of the connected sensors can be displayed in the following ways:

- Clear display of all connected sensors
- Detailed display of one sensor
(e.g. incl. CMC feature with pH sensors)

With the softkey you can very easily switch between the two display types. The suitable softkey is displayed depending on the operating situation.

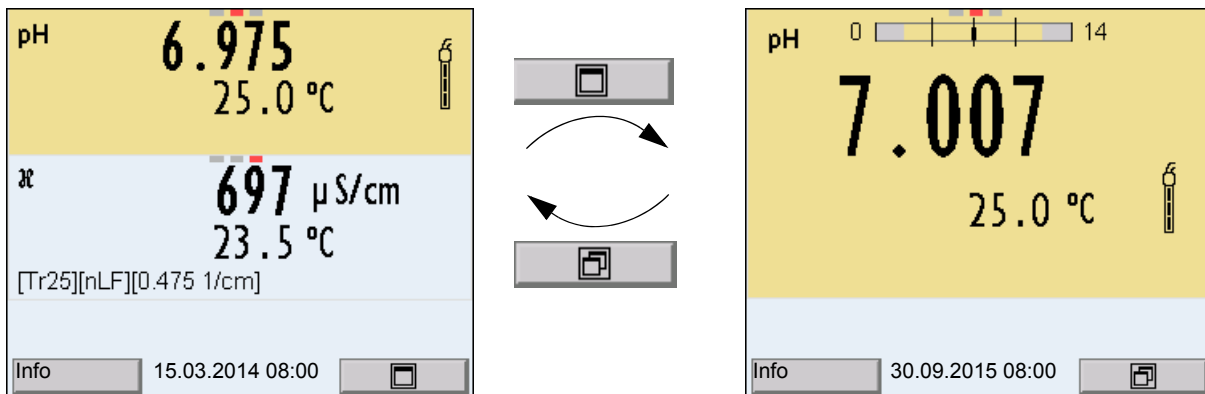

4.2 Switching on the meter

- 1 Switch the meter on with **<On/Off>**.
The meter performs a self-test.
- 2 Connect the sensor.
The meter is ready to measure.

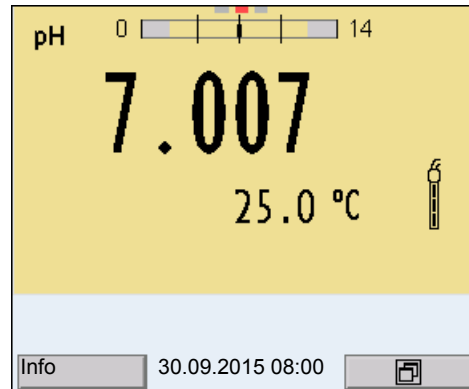

If the user administration function is activated, the *Login* dialog appears after the meter is switched on (see section 4.4).

The user administration function is not active in the delivery condition.

The user administration is activated by the administrator via the PC software MultiLab User (see MultiLab User operating manual).

4.3 Switching off the meter

- 1 Switch the printer off with **<On/Off>**.

4.4 Login with user name

After activation of the user administration by the administrator (software Multi-Lab User, on enclosed CD-ROM), measurements with the meter are only possible after login with a user name. The user name is documented with the measured values and in records.

All user names entered by the administrator are listed in the *User name* menu. The administrator determines for each user whether or not a password is required for the login to the meter.

If the *Password* menu item is grayed out, no password is required for the login.

- 1 Switch the meter on with **<On/Off>** (or **<On/Off_>**).
The *Login* dialog appears.

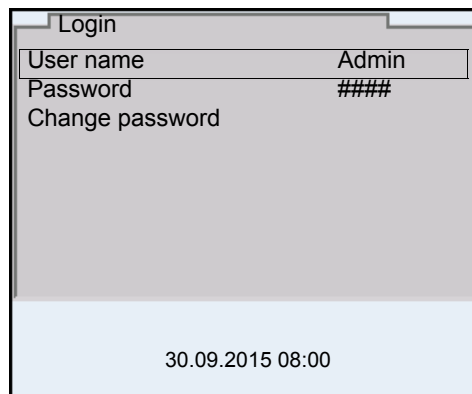

- 2 Using **<▲><▼>**, select the menu item, *User name* and confirm with **<ENTER>**.
The user name is highlighted.
- 3 Using **<▲><▼>**, select a user name and confirm with **<ENTER>**.



The login is done immediately if no password is required.
If a sensor is connected the measured value display appears.

- 4 If a password is required:
Using **<▲><▼>**, select the menu item, *Password* and confirm with **<ENTER>**.



The user specifies the password when he or she first logs in with a user name.
A valid password consists of 4 digits.
The user can change the password with the next login.

- 5 Change the digit of the highlighted position with <▲><▼>. Switch to the next position of the password with <◀><▶>. When the password was completely entered, confirm with <ENTER>. The login takes place. If a sensor is connected the measured value display appears.

Changing the password

If the administrator has set up the access with password protection:

- 1 Switch the meter on with <On/Off> (or <On/Off_>). The *Login* dialog appears.
- 2 Using <▲><▼>, select the menu item, *User name* and confirm with <ENTER>. The user name is highlighted.
- 3 Using <▲><▼>, select a user name and confirm with <ENTER>.
- 4 Using <▲><▼>, select the menu item, *Change password* and confirm with <ENTER>.
- 5 In the *Password* field, enter the old password with <▲><▼> and <◀><▶> and confirm it with <ENTER>.
- 6 In the *New password* field, enter the new password with <▲><▼> and <◀><▶> and confirm it with <ENTER>. The password is changed. The login takes place. If a sensor is connected the measured value display appears.

Forgotten the password?

Contact the administrator.

4.5 Navigation

4.5.1 Operating modes

Operating mode	Explanation
Measuring	The measurement data of the connected sensor are shown in the measured value display
Calibration	The course of a calibration with calibration information, functions and settings is displayed

Operating mode	Explanation
Storing in memory	The meter stores measuring data automatically or manually
Transmitting data	The meter transmits measuring data and calibration records to a USB-B interface automatically or manually.
Setting	The system menu or a sensor menu with submenus, settings and functions is displayed

4.5.2 Measured value display

In the measured value display, you can

- use <▲><▼> to select one of several connected sensors. The selected sensor is displayed with a colored background.
The following actions / menus refer to the selected sensor
- open the menu for calibration and measurement settings with <ENTER> (short keystroke)
- open the *Storage & config* menu with the sensor-independent settings with <ENTER_> (long pressure (approx. 2 s) on <ENTER>).
- change the display in the selected measuring screen (e. g. pH <-> mV) by pressing <M>.

4.5.3 Menus and dialogs

The menus for settings and dialogs in procedures contain further subelements. The selection is done with the <▲><▼> keys. The current selection is displayed with a frame.

- Submenus
The name of the submenu is displayed at the upper edge of the frame. Submenus are opened by confirming with <ENTER>. Example:

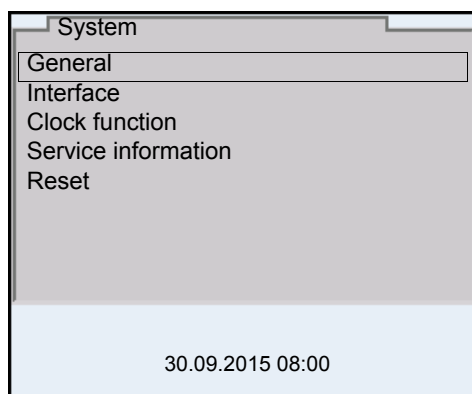

- Settings
Settings are indicated by a colon. The current setting is displayed on the right-hand side. The setting mode is opened with <ENTER>. Subsequently,

the setting can be changed with <▲><▼> and <ENTER>. Example:

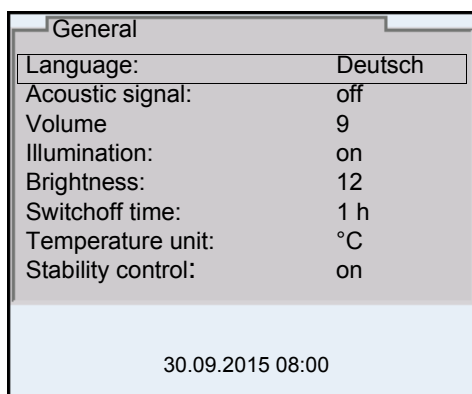

- **Functions**

Functions are designated by the name of the function. They are immediately carried out by confirming with <ENTER>. Example: Display the *Calibration record* function.

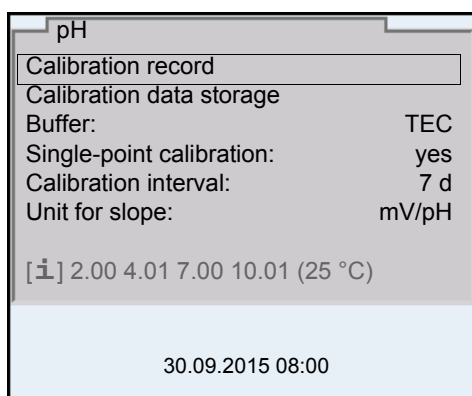

- **Messages**

Information is marked by the [i] symbol. It cannot be selected. Example:

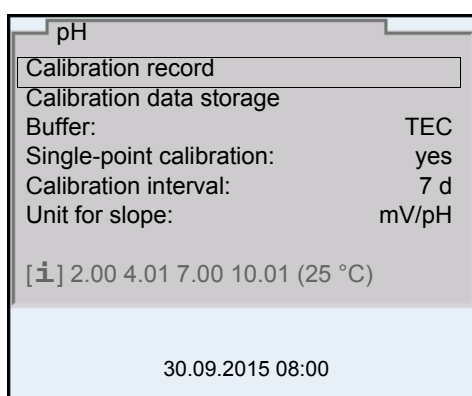

The principles of navigation are explained in the two following sections by reference of examples:

- Setting the language (section 4.5.4)
- Setting the date and time (see section 4.5.5).

4.5.4 Navigation example 1: Setting the language

- 1 Press the **<On/Off>** key.
The measured value display appears.
The instrument is in the measuring mode.

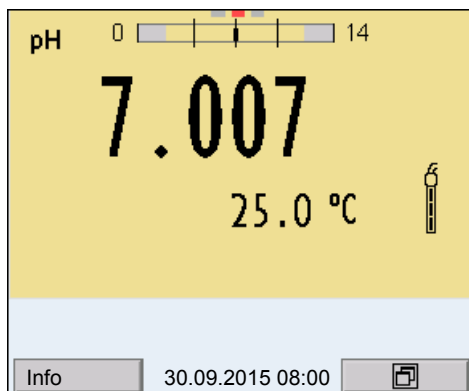

- 2 Open the *Storage & config* menu with **<ENTER_>**.
The instrument is in the setting mode.

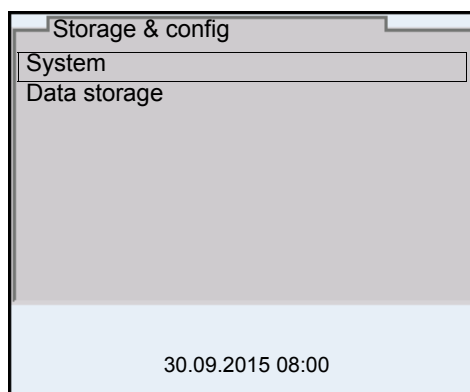

- 3 Select the *System* submenu with **<▲><▼>**.
The current selection is displayed with a frame.
- 4 Open the *System* submenu with **<ENTER>**.

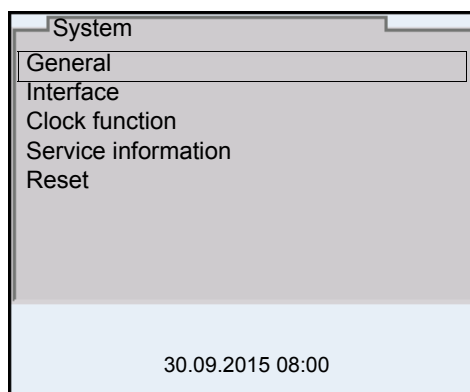

- 5 Select the *General* submenu with <▲><▼>. The current selection is displayed with a frame.
- 6 Open the *General* submenu with <ENTER>.

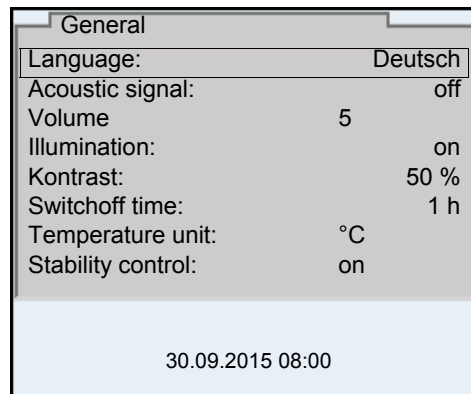

- 7 Open the setting mode for the *Language* with <ENTER>.

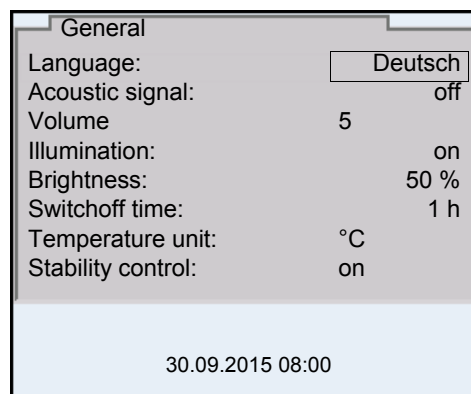

- 8 Select the required language with <▲><▼>.
- 9 Confirm the setting with <ENTER>. The meter switches to the measuring mode. The selected language is active.

4.5.5 Example 2 on navigation: Setting the date and time

The meter has a clock with a date function. The date and time are indicated in the status line of the measured value display. When storing measured values and calibrating, the current date and time are automatically stored as well.

The correct setting of the date and time and date format is important for the following functions and displays:

- Current date and time

- Calibration date
- Identification of stored measured values.

Therefore, check the time at regular intervals.



The date and time are reset to default after a fall of the supply voltage (empty batteries).

Setting the date, time and date format

The date format can be switched from the display of day, month, year (*dd.mm.yy*) to the display of month, day, year (*mm/dd/yy* or *mm.dd.yy*).

- 1 In the measured value display:
Open the *Storage & config* menu with **<ENTER_>**.
The instrument is in the setting mode.
- 2 Select and confirm the *System / Clock function* menu with **<▲><▼>** and **<ENTER>**.
The setting menu for the date and time opens up.

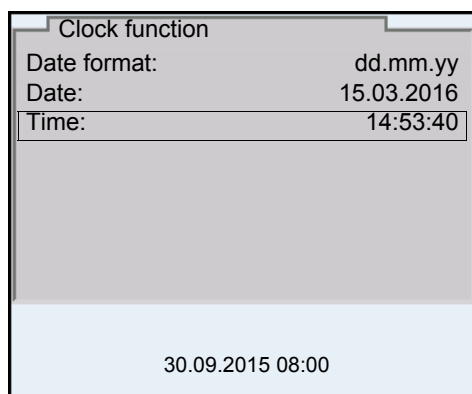

- 3 Select and confirm the *Time* menu with **<▲><▼>** and **<ENTER>**.
The hours are highlighted.
- 4 Change and confirm the setting with **<▲><▼>** and **<ENTER>**.
The minutes are highlighted.
- 5 Change and confirm the setting with **<▲><▼>** and **<ENTER>**.
The seconds are highlighted.
- 6 Change and confirm the setting with **<▲><▼>** and **<ENTER>**.
The time is set.
- 7 If necessary, set the *Date* and *Date format*. The setting is made similarly to that of the time.
- 8 To make further settings, switch to the next higher menu level with **<ESC>**.
or
Switch to the measured value display with **<M>**.
The instrument is in the measuring mode.

5 pH value

5.1 Measuring

5.1.1 Measuring the pH value



The sensor connection and the USB-B (device) interface are galvanically insulated. This facilitates interference-free measurements also in the following cases:

- Measurement in grounded test samples
- Measurement with several sensors connected to one Multi 3620 IDS in one test sample

- 1 Connect the IDS-pH sensor to the meter. The pH measuring window is displayed.
- 2 If necessary, select the measured parameter with **<M>**.
- 3 If necessary, calibrate or check the IDS-pH sensor.
- 4 Immerse the IDS-pH sensor in the test sample.

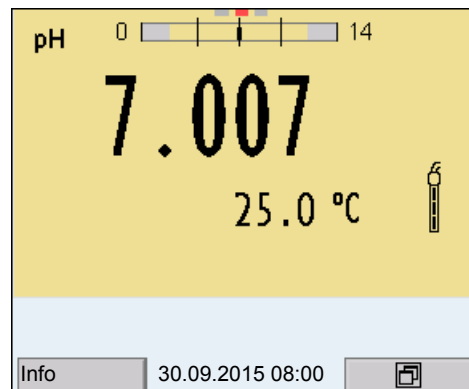

- 5 Select the pH or mV display with **<M>**.

Stability control (AutoRead)

The stability control function (*AutoRead*) continually checks the stability of the measurement signal. The stability has a considerable impact on the reproducibility of measured values. The display of the measured parameter flashes until a stable measured value is available.

You can start the *Stability control* function manually at any time, irrespective of the setting for automatic *Stability control* (see section 10.6.3) in the *System* menu.

- 1 Freeze the measured value with **<AR>**. The [HOLD] status indicator is displayed.

- 2 Using **<ENTER>**, activate the *Stability control* function manually. The [AR] status indicator appears while the measured value is assessed as not stable. A progress bar is displayed and the display of the measured parameter flashes. The [HOLD][AR] status indicator appears as soon as a stable measured value is recognized. The progress bar disappears and the display of the measured parameter stops flashing. The current measurement data is output to the interface. Measurement data meeting the stability control criterion is marked by AR.



You can prematurely terminate the *Stability control* function manually with **<ENTER>** at any time. If the *Stability control* function is prematurely terminated, the current measurement data are output to the interface without the AutoRead info.

- 3 Release the frozen measured value again with **<AR>** or **<M>**. The [AR] status display disappears. The display switches back to the previous indication.

Criteria for a stable measured value

The *Stability control* function checks whether the measured values are stable within the monitored time interval.

Measured parameter	Time interval	Stability in the time interval
pH value	15 seconds	Δ : better than 0.01 pH
Temperature	15 seconds	Δ : better than 0.5 °C

The minimum duration until a measured value is assessed as stable is the monitored time interval. The actual duration is mostly longer.

5.1.2 Measuring the temperature

For reproducible pH measurements, it is essential to measure the temperature of the test sample.

Most IDS sensors measure the temperature with a temperature sensor integrated in the IDS sensor.

When operating a sensor without integrated temperature sensor, e.g. via an IDS-pH adapter, there are the following ways to measure the temperature of the test sample:

- Measurement of the temperature with the integrated temperature sensor of an IDS sensor.
If the measured value is taken over from an IDS sensor, the status indicator [TP ↑] is displayed in the measurement window of the IDS-pH adapter. The status indicator [TP ↓] is displayed in the measurement window of the IDS-pH sensor providing the temperature value.
- Manual determination and input of the temperature.



The settings for the temperature are selected in the menu for calibration and measurement settings (see section 10.1.1).

5.2 pH calibration

5.2.1 Why calibrate?

During the operation of an IDS-pH sensor, the zero point (asymmetry) and slope of the sensor change with time. As a result, an inexact measured value is displayed. Calibration determines the current values of the zero point and slope of the pH sensor and stores them in the measuring instrument. Thus, you should calibrate at regular intervals.

5.2.2 When do you have to calibrate?

- Routinely within the framework of the company quality assurance
- When the calibration interval has expired

5.2.3 Automatic calibration (AutoCal)

Make sure that in the sensor menu, *Buffer* menu, the buffer set is correctly selected (see section 10.1.1).

Use one to five buffer solutions of the selected buffer set in any order.

Below, calibration with Technical buffers (TEC) is described. When other buffer sets are used, other nominal buffer values are displayed. Apart from that, the procedure is identical.



If single-point calibration was set in the menu, the calibration procedure is automatically finished with the measurement of buffer solution 1 and the calibration record is displayed.

- 1 In the measured value display, select the measured parameter pH or mV with <M>.

- 2 Start the calibration with **<CAL>**.
The calibration display for the first buffer appears (voltage display).

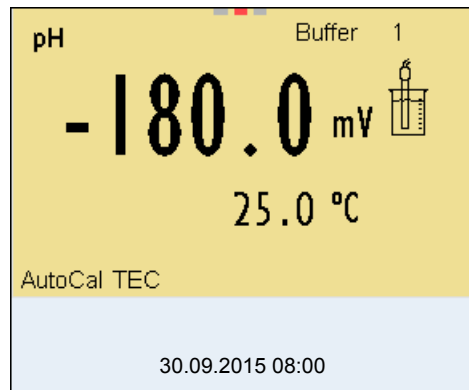

- 3 Thoroughly rinse the IDS sensor with deionized water.
- 4 Immerse the IDS-pH sensor in buffer solution 1.
- 5 For measurements without temperature sensor (e.g. when using an IDS adapter):
Measure the temperature of the buffer manually and enter it with **<▲><▼>**.
- 6 Start the measurement with **<ENTER>**.
The measured value is checked for stability (stability control).
The [AR] status indicator is displayed. The measured parameter flashes.

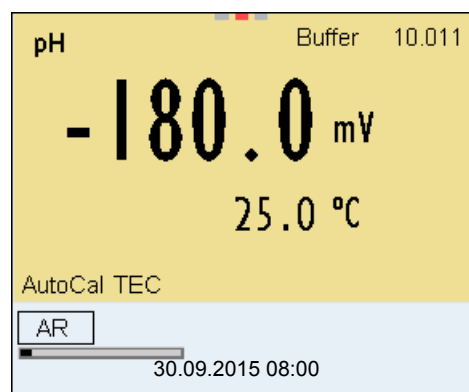

- 7 Wait for the end of the measurement with stability control or accept the calibration value with **<ENTER>**.
The calibration display for the next buffer appears (voltage display).
- 8 If necessary, finish the calibration procedure as a single-point calibration with **<M>**.
The calibration record is displayed.



For **single-point calibration**, the instrument uses the Nernst slope (-59.2 mV/pH at 25 °C) and determines the zero point of the IDS-pH sensor.

Continuing with two-point calibration

- 9 Thoroughly rinse the IDS sensor with deionized water.
- 10 Immerse the IDS-pH sensor in buffer solution 2.
- 11 When measuring without temperature sensor:
Measure the temperature of the buffer manually and enter it with **<▲><▼>**.
- 12 Start the measurement with **<ENTER>**.
The measured value is checked for stability (stability control).
The [AR] status indicator is displayed. The measured parameter flashes.

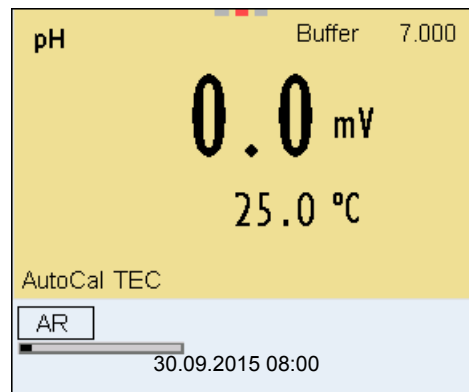

- 13 Wait for the measurement with stability control to be completed or terminate the stability control and take over the calibration value with **<ENTER>**.
The calibration display for the next buffer appears (voltage display).
- 14 If necessary, finish the calibration procedure as a two-point calibration with **<M>**.
The calibration record is displayed.

Continuing with three- to five-point calibration

- 15 Thoroughly rinse the IDS-pH sensor with deionized water.
- 16 Immerse the IDS-pH sensor in the next buffer solution.
- 17 When measuring without temperature sensor:
Measure the temperature of the buffer manually and enter it with **<▲><▼>**.
- 18 Start the measurement with **<ENTER>**.
The measured value is checked for stability (stability control).
The [AR] status indicator is displayed. The measured parameter flashes.

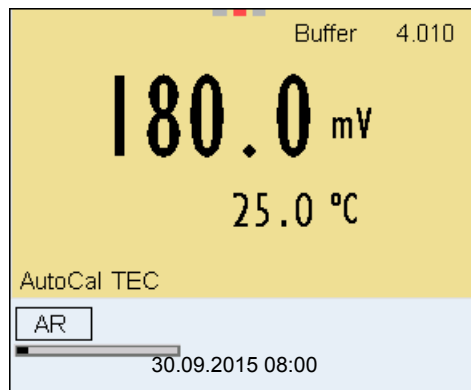

- 19 Wait for the measurement with stability control to be completed or terminate the stability control and take over the calibration value with **<ENTER>**.
The calibration display for the next buffer appears (voltage display).
- 20 If necessary, use **<M>** to finish the calibration.
The calibration record is displayed.
or
Switch to calibration with the next buffer with **<ENTER>**.



Calibration is automatically completed after the last buffer of a buffer set has been measured. Then the calibration record is displayed.

The calibration line is determined by linear regression.

5.2.4 Manual calibration (ConCal)

Make sure that in the sensor menu, *Buffer* menu, the *ConCal* buffer set is correctly selected (see section 10.1.1).

Use one to five buffer solutions in any order. The pH values of the buffer solutions should differ by at least one pH unit.



If single-point calibration was set in the menu, the calibration procedure is automatically finished with the measurement of buffer solution 1 and the calibration record is displayed.

- 1 In the measured value display, select the measured parameter pH or mV with **<M>**.
- 2 Start the calibration with **<CAL>**.
The calibration display for the first buffer appears (voltage display).

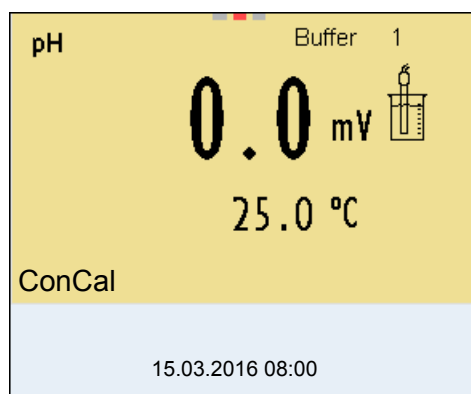

- 3 Thoroughly rinse the IDS sensor with deionized water.
- 4 Immerse the IDS sensor in buffer solution 1.
- 5 For measurements without temperature sensor (e.g. when using an IDS adapter): Measure the temperature of the buffer manually and enter it with **<▲><▼>**.
- 6 Start the measurement with **<ENTER>**. The measured value is checked for stability (stability control). The [AR] status indicator is displayed. The measured parameter flashes.

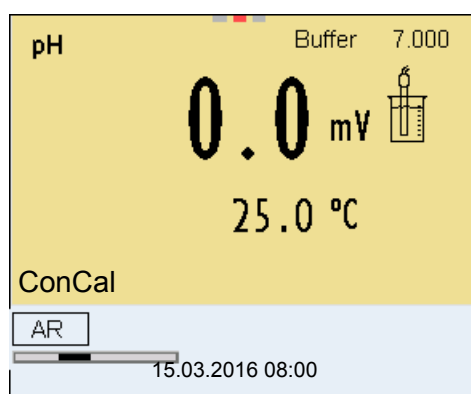

- 7 Wait for the measurement with stability control to be completed or terminate the stability control and take over the calibration value with **<ENTER>**. The pH value of the buffer solution is displayed.

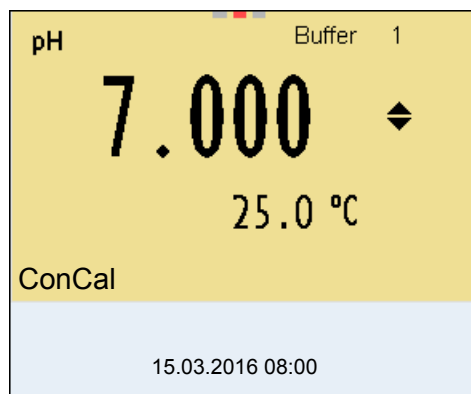

- 8 Set the nominal buffer value for the measured temperature with **<▲><▼>**.
- 9 Accept the calibration value with **<ENTER>**.
The calibration display for the next buffer appears (voltage display).
- 10 If necessary, finish the calibration procedure as a single-point calibration with **<M>**.
The calibration record is displayed.



For **single-point calibration**, the instrument uses the Nernst slope (-59.2 mV/pH at 25 °C) and determines the zero point of the IDS-pH sensor.

Continuing with two-point calibration

- 11 Thoroughly rinse the IDS sensor with deionized water.
- 12 Immerse the IDS sensor in buffer solution 2.
- 13 When measuring without temperature sensor:
Measure the temperature of the buffer manually and enter it with **<▲><▼>**.
- 14 Start the measurement with **<ENTER>**.
The measured value is checked for stability (stability control).
The [AR] status indicator is displayed. The measured parameter flashes.
- 15 Wait for the measurement with stability control to be completed or terminate the stability control and take over the calibration value with **<ENTER>**.
The pH value of the buffer solution is displayed.

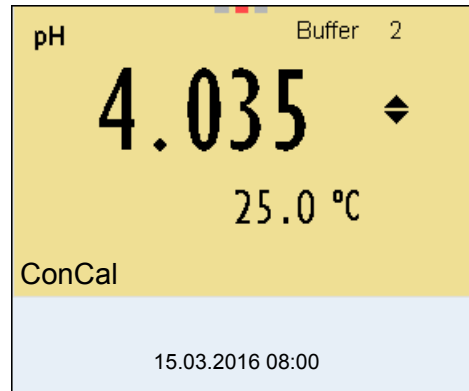

- 16 Set the nominal buffer value for the measured temperature with **<▲><▼>**.
- 17 Accept the calibration value with **<ENTER>**.
The calibration display for the next buffer appears (voltage display).
- 18 If necessary, finish the calibration procedure as a two-point calibration with **<M>**.
The calibration record is displayed.

**Continuing with
three- to five-point
calibration**

- 19 Thoroughly rinse the IDS-pH sensor with deionized water.
- 20 Immerse the IDS-pH sensor in the next buffer solution.
- 21 When measuring without temperature sensor:
Measure the temperature of the buffer manually and enter it with **<▲><▼>**.
- 22 Start the measurement with **<ENTER>**.
The measured value is checked for stability (stability control).
The [AR] status indicator is displayed. The measured parameter flashes.
- 23 Wait for the measurement with stability control to be completed or terminate the stability control and take over the calibration value with **<ENTER>**.
The pH value of the buffer solution is displayed.

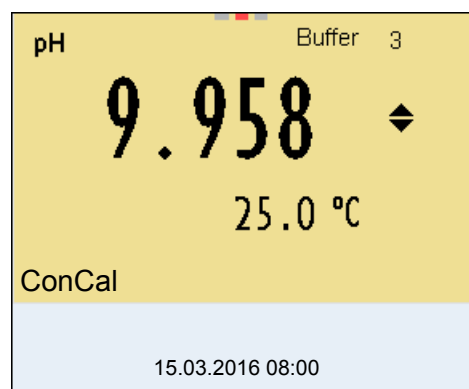

- 24 Set the nominal buffer value for the measured temperature with **<▲><▼>**.
- 25 Accept the calibration value with **<ENTER>**.
The calibration display for the next buffer appears (voltage display).
- 26 If necessary, use **<M>** to finish the calibration.
The calibration record is displayed.
or
Continue calibrating using the next buffer with **<ENTER>**.



After the fifth buffer has been measured the calibration is automatically finished. Then the calibration record is displayed.

The calibration line is determined by linear regression.

5.2.5 Calibration points

Calibration can be performed using one to five buffer solutions in any order (single-point to five-point calibration). The meter determines the following values and calculates the calibration line as follows:

	Determined values	Displayed calibration data
1-point	<i>Asy</i>	<ul style="list-style-type: none"> ● Zero point = <i>Asy</i> ● Slope = Nernst slope (-59.2 mV/pH at 25 °C)
2-point	<i>Asy</i> <i>Slp.</i>	<ul style="list-style-type: none"> ● Zero point = <i>Asy</i> ● Slope = <i>Slp.</i>
3-point to 5-point	<i>Asy</i> <i>Slp.</i>	<ul style="list-style-type: none"> ● Zero point = <i>Asy</i> ● Slope = <i>Slp.</i> <p>The calibration line is calculated by linear regression.</p>



You can display the slope in the units, mV/pH or % (see section 10.1.1).

5.2.6 Calibration data

The calibration data can be displayed and then output to the interface.

Displaying the calibration data



The calibration protocol of the last calibration is available in the menu *Calibration / Calibration record*. To open it in the measured value display, press the **<CAL_>** key.

The calibration records of the last 10 calibrations are available in the menu *Calibration / Calibration data storage / Display*. To open the *Calibration* menu in the measured value display, press the **<ENTER>** key.

Menu item	Setting/function	Explanation
<i>Calibration / Calibration data storage / Display</i>	-	Displays the calibration records. Further options: <ul style="list-style-type: none"> ● Scroll through the calibration records with <<>><>>. ● Output the displayed calibration record to the interface with <PRT>. ● Output all calibration records to the interface with <PRT_>. ● Quit the display with <ESC> or <ENTER>. ● Switch directly to the measured value display with <M>.
<i>Calibration / Calibration data storage / Output to USB flash drive or printer</i>	-	Outputs the stored calibration data to the USB-A interface (USB memory device/USB printer)
<i>Calibration / Calibration data storage / Output to RS232/USB</i>	-	Outputs the stored calibration data to the USB-B interface (PC)

Calibration evaluation

After calibrating, the meter automatically evaluates the calibration. The zero point and slope are evaluated separately. The worse evaluation of both is taken into account. The evaluation appears on the display and in the calibration record.

Display	Calibration record	Zero point [mV]	Slope [mV/pH]
	+++	-15 ... +15	-60.5 ... -58
	++	-20 ... +20	-58 ... -57
	+	-25 ... +25	-61 ... -60.5 or -57 ... -56

Display	Calibration record	Zero point [mV]	Slope [mV/pH]
 Clean the IDS sensor according to the sensor operating manual	-	-30 ... +30	-62 ... -61 or -56 ... -50
<i>Error</i> Eliminate the error according to chapter 14 WHAT TO DO IF...	<i>Error</i>	< -30 or > 30	... -62 or ... -50



For pH IDS sensors, you can optionally enable a more finely graded calibration evaluation (QSC) (see section 5.4).

Calibration record (USB output)

```
Multi 3620 IDS
Ser. no. 09250023

CALIBRATIONpH
Calibration date 15.03.2016 16:13:33
SenTix 940
Ser. no. B092500013

TEC
Buffer 1          4.01
Buffer 2          7.00
Buffer 3          10.01
Voltage 1         184.0 mV   24.0 °C
Voltage 2         3.0 mV    24.0 °C
Voltage 3        -177.0 mV   24.0 °C
Slope             -60.2 mV/pH
Asymmetry         4.0 mV
Sensor            +++

etc...
```

5.3 Continuous measurement control (CMC function)

The Continuous Measurement Control (CMC function) facilitates to evaluate the current measured value instantly and definitely.

After each successful calibration the scale of the pH measuring range is displayed in the measured value display. Here you can very clearly see whether or not the current measured value is in the calibrated part of the measuring range.

The following information is displayed:

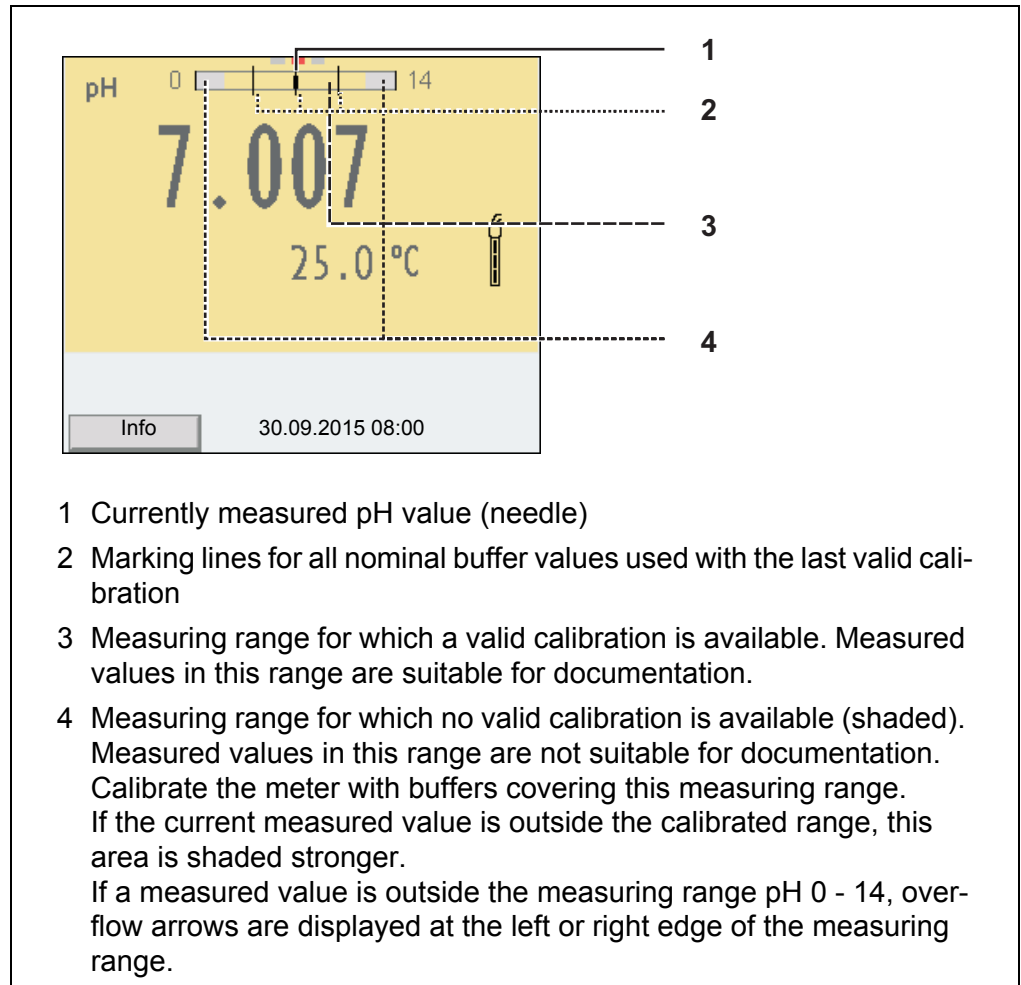

The limits of the calibrated range are determined by the buffers used for calibration:

Lower limit:	Buffer with lowest pH value - 2 pH units
Upper limit:	Buffer with highest pH value + 2 pH units

5.4 QSC function (sensor quality control)

General information on the QSC function

The QSC function (Quality Sensor Control) is a new sensor evaluation for digital IDS sensors. It evaluates the condition of an IDS-pH sensor individually and with a very fine grading.

On the display, the QSC color scale (from green to yellow) indicates the current sensor evaluation by means of a pointer.

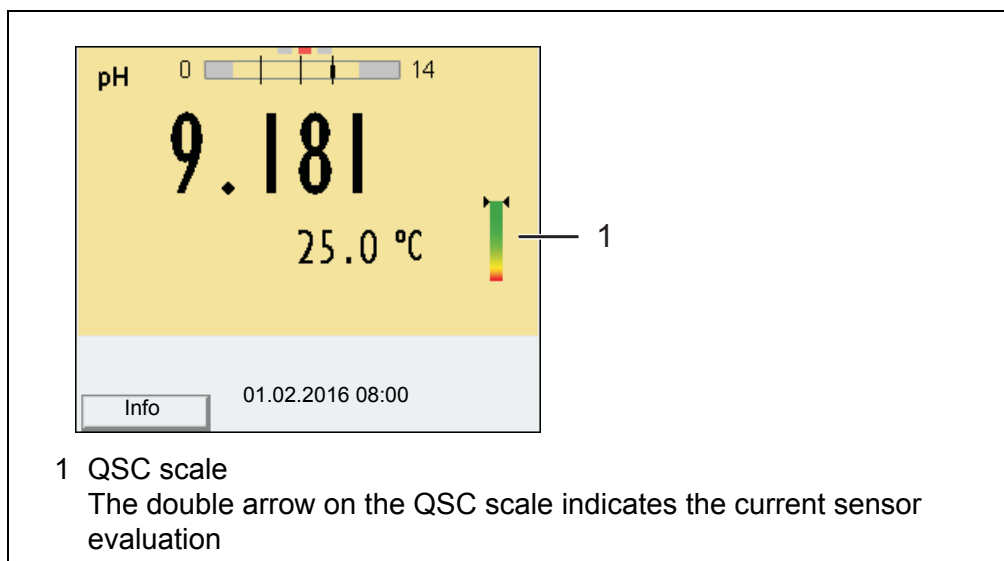

In the printout, the sensor evaluation is quoted as a percentage (1-100).

The finely graded sensor evaluation of the QSC function promptly calls your attention to changes of the sensor.

Thus you can do what is necessary to restore the optimum measuring quality (e.g. clean, calibrate or replace the sensor).

Sensor evaluation with / without QSC function

With QSC function	Without QSC function (sensor symbol)
Very fine grading of the sensor evaluation (100 grades)	Rough grading of the sensor evaluation (4 grades)
The reference value is individually determined for each sensor during the QSC initial calibration.	A theoretical reference value is used for all sensors
Low tolerances for zero point and slope when using QSC buffer solutions	Greater tolerances for zero point and slope when using commercial buffer sets
Additional QSC calibration required (with special QSC buffer set)	No additional calibration required

QSC calibration

The QSC function is enabled by once carrying out an additional three-point calibration with special QSC buffer solutions. It covers the measuring range of the sensor (pH 2 to pH 11). The QSC initial calibration determines the actual condition of the sensor and stores it as a reference in the sensor.

To meet the high requirements of a QSC initial calibration, the QSC initial calibration should optimally be carried out with the initial commissioning of the sensor.

Carry out the normal calibrations for your special measuring range with your usual standard solutions as previously done.



As soon as the QSC function was enabled for an IDS sensor, it is not possible to return to the sensor evaluation with the sensor symbol for this sensor.

Carrying out a QSC initial calibration

- 1 Open the menu for measurement settings with **<ENTER>**.
- 2 In the QSC menu, select *First calibration* with **<▲><▼>**.
The calibration display appears. *AutoCal QSC-Kit* is displayed as the buffer.
Exclusively use the QSC-Kit for the QSC calibration. If you use other buffers, you will have no valid QSC calibration.

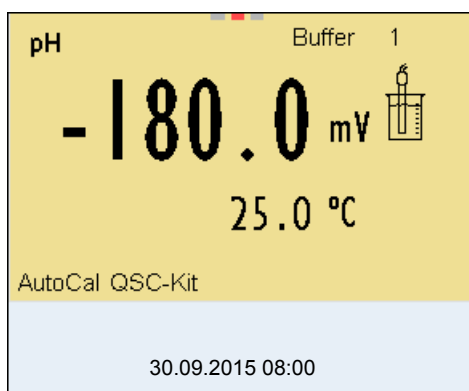

- 3 Calibration with the buffers of the QSC-Kit is done like a normal three-point calibration.
Follow the user guide.



Carry out the QSC initial calibration very carefully. It determines the reference value for the sensor. This reference value cannot be overwritten or reset.

As soon as the QSC function was enabled, it is not possible to return to the sensor evaluation with the sensor symbol.

- 4 As soon as the three-point calibration has been successfully carried out you can decide whether to accept or discard the calibration as the QSC initial calibration.

The QSC initial calibration is completed. The sensor is calibrated. If you want to calibrate with special buffers for your measurements, you can subsequently carry out a normal calibration with your buffers. The reference values determined with the QSC calibration are also used for the evaluation of normal calibrations. In the measured value display, the color scale of the QSC function is always displayed. A double arrow on the color scale indicates the current sensor evaluation.

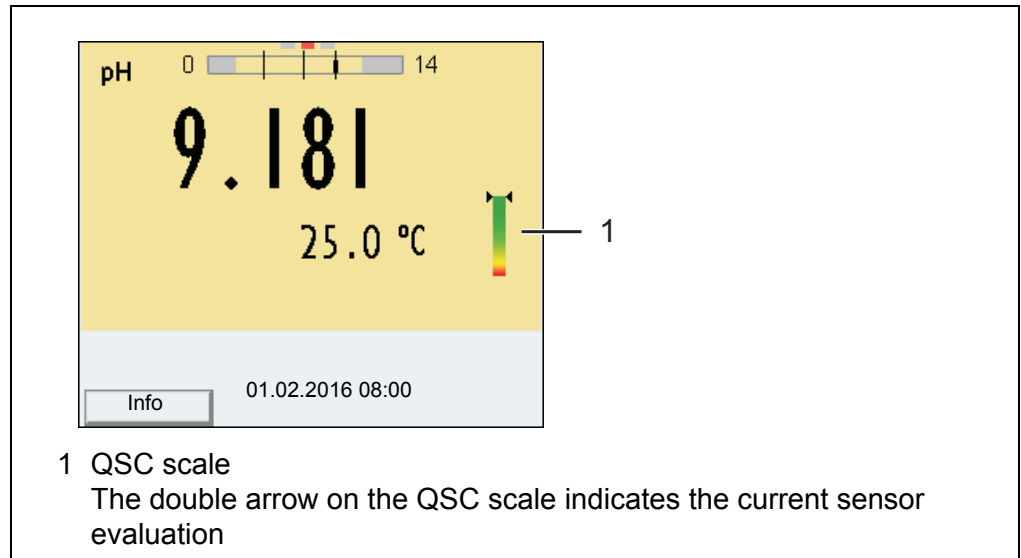

You can carry out QSC control calibrations at greater intervals than normal calibrations.

A QSC control calibration can, e.g. be useful if the sensor evaluation noticeably changed (after some normal calibrations).

Carrying out a QSC control calibration

- 1 Open the menu for measurement settings with **<ENTER>**.
- 2 In the QSC menu, select *Control calibration* with **<▲><▼>**.
The calibration display appears. *AutoCal QSC-Kit* is displayed as the buffer.
Exclusively use the QSC-Kit for the QSC calibration. If you use other buffers, you will have no valid QSC control calibration.
- 3 Follow the user guide.
The calibration is carried out like a normal three-point calibration. As soon as the three-point calibration has been successfully carried out you can decide whether to accept or discard the calibration as the QSC control calibration.

6 ORP

6.1 Measuring

6.1.1 Measuring the ORP



The sensor connection and the USB-B (device) interface are galvanically insulated. This facilitates interference-free measurements also in the following cases:

- Measurement in grounded test samples
- Measurement with several sensors connected to one Multi 3620 IDS in one test sample

- 1 Connect the IDS-ORP sensor to the meter. The ORP measuring window is displayed.
- 2 Check the meter with the IDS-ORP sensor.
- 3 Immerse the IDS-ORP sensor in the test sample.

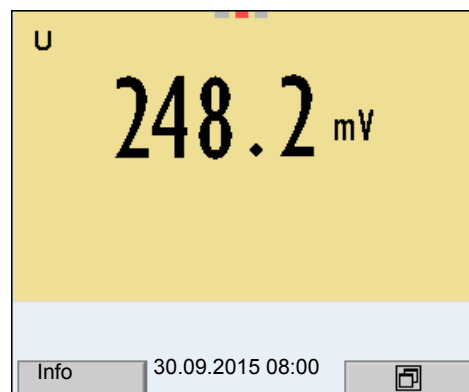

- 4 Select the mV display with **<M>**.

Stability control (AutoRead)

The stability control function (*AutoRead*) continually checks the stability of the measurement signal. The stability has a considerable impact on the reproducibility of measured values. The display of the measured parameter flashes until a stable measured value is available.

You can start the *Stability control* function manually at any time, irrespective of the setting for automatic *Stability control* (see section 10.6.3) in the *System* menu.

- 1 Freeze the measured value with **<AR>**. The [HOLD] status indicator is displayed.

- 2 Using **<ENTER>**, activate the *Stability control* function manually. The [AR] status indicator appears while the measured value is assessed as not stable. A progress bar is displayed and the display of the measured parameter flashes. The [HOLD][AR] status indicator appears as soon as a stable measured value is recognized. The progress bar disappears and the display of the measured parameter stops flashing. The current measurement data is output to the interface. Measurement data meeting the stability control criterion is marked by AR.



You can prematurely terminate the *Stability control* function manually with **<ENTER>** at any time. If the *Stability control* function is prematurely terminated, the current measurement data are output to the interface without the AutoRead info.

- 3 Release the frozen measured value again with **<AR>** or **<M>**. The [AR] status display disappears. The display switches back to the previous indication.

Criteria for a stable measured value

The *Stability control* function checks whether the measured values are stable within the monitored time interval.

Measured parameter	Time interval	Stability in the time interval
ORP	15 seconds	Δ : better than 0.3 mV
Temperature	15 seconds	Δ : better than 0.5 °C

The minimum duration until a measured value is assessed as stable is the monitored time interval. The actual duration is mostly longer.

6.1.2 Measuring the temperature

For reproducible ORP measurements, it is essential to measure the temperature of the test sample.

When operating a sensor without integrated temperature sensor, you first have to measure and enter the temperature of the sample.

The measuring instrument recognizes whether a suitable sensor is connected and automatically switches on the temperature measurement.

The display of the temperature indicates the active temperature measuring mode:

Temperature sensor	Resolution of the temp. display	Mode
yes	0.1 °C	Automatic with temperature sensor
-	1 °C	Manual

6.2 ORP calibration



ORP electrodes are not calibrated. You can, however, check ORP electrodes by measuring the ORP of a test solution and comparing the value with the nominal value.

7 Dissolved oxygen

7.1 Measuring

7.1.1 Measuring D.O.



The sensor connection and the USB-B (device) interface are galvanically insulated. This facilitates interference-free measurements also in the following cases:

- Measurement in grounded test samples
- Measurement with several sensors connected to one Multi 3620 IDS in one test sample

- 1 Connect the D.O. sensor to the meter. The D.O. measuring screen is displayed.
- 2 Check or calibrate the meter with the sensor.
- 3 Immerse the D.O. sensor in the test sample.

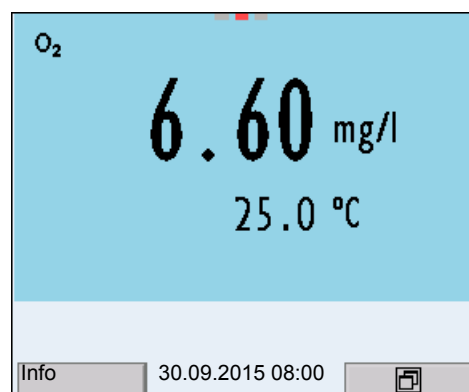

Selecting the displayed measured parameter

You can switch between the following displays with **<M>**:

- D.O. concentration [mg/l]
- D.O. saturation [%]
- D.O. partial pressure [mbar].

Salinity correction

When measuring the concentration of solutions with a salt content of more than 1 g/l, a salinity correction is required.

You have the following options to measure the salinity:

- Measurement of the salinity with an IDS conductivity sensor.
If the measured value from an IDS conductivity sensor is taken over, the status indicator [Sal ↑] is displayed in the measurement window of the IDS oxygen sensor. The status indicator [Sal ↓] is displayed in the measurement window of the IDS conductivity sensor.
- Manual determination and input of the salinity.



You can switch the salinity correction on or off and enter the salinity in the menu for calibration and measurement settings (see section 10.4.1).

Freezing the measured value (HOLD function)

With the HOLD function, you can freeze the current measured value. The displayed measured value stops changing until you switch the HOLD function off.

- 1 Freeze the measured value with **<AR>**.
The [HOLD] status indicator is displayed.



If the HOLD function is active, you can, e.g. start a manual measurement with stability control.

- 2 Release the frozen measured value again with **<AR>**.
The HOLD function is switched off.
The [HOLD] status display disappears.

Stability control (AutoRead)

The stability control function (*AutoRead*) continually checks the stability of the measurement signal. The stability has a considerable impact on the reproducibility of measured values. The display of the measured parameter flashes until a stable measured value is available.

You can start a measurement with *Stability control* manually at any time, irrespective of the setting for automatic *Stability control* (see section 10.6.3) in the *System* menu.

- 1 Freeze the measured value with **<AR>**.
The [HOLD] status indicator is displayed.
- 2 Using **<ENTER>**, activate the *Stability control* function manually. The [AR] status indicator appears while the measured value is assessed as not stable. A progress bar is displayed and the display of the measured parameter flashes.
The [HOLD][AR] status indicator appears as soon as a stable measured value is recognized. The progress bar disappears and the display of the measured parameter stops flashing.
The current measurement data is output to the interface. Measurement data meeting the stability control criterion is marked by AR.



You can prematurely terminate the *Stability control* function manually with **<ENTER>** at any time. If the *Stability control* function is prematurely terminated, the current measurement data are not output to the interface.

- 3 Using **<ENTER>**, start a further measurement with *Stability control*.
or
Release the frozen measured value again with **<AR>**.
The display switches to the measured value display.
The [AR][HOLD] status display disappears.

Criteria for a stable measured value

The *Stability control* function checks whether the measured values are stable within the monitored time interval.

Measured parameter	Time interval	Stability in the time interval
D.O. concentration	20 seconds	Δ : better than 0.03 mg/l
D.O. saturation	20 seconds	Δ : better than 0.4 %
D.O. partial pressure	20 seconds	Δ : Better than 0.8 mbar
Temperature	15 seconds	Δ : better than 0.5 °C

The minimum duration until a measured value is assessed as stable is the monitored time interval. The actual duration is mostly longer.

7.1.2 Measuring the temperature

For reproducible D.O. measurements, it is essential to measure the temperature of the test sample.

IDS D.O. sensors measure the temperature with a temperature sensor integrated in the IDS sensor.

7.2 FDO[®] check procedure (check of the FDO[®] 925)

7.2.1 Why should you check the sensor?

With the FDO[®] Check procedure, you can find out in a simple manner whether the FDO[®] 925[®] D.O. sensor should be cleaned or calibrated.

7.2.2 When should you check the sensor?

Checking can be useful in the following cases:

- When the check interval has expired
- If the measured values seem to be implausible
- If you assume that the sensor cap is contaminated or at the end of its lifetime
- After the sensor cap was exchanged

- Routinely within the framework of the company quality assurance

7.2.3 Carrying out the FDO[®] check procedure

FDO[®] check procedure	Check in water vapor-saturated air. Use the check and storage beaker (FDO [®] Check) to carry out the FDO [®] Check [®] procedure.
Stability control (AutoRead)	The Stability control function (AutoRead) is automatically activated for the FDO [®] Check.

Proceed as follows to carry out the FDO[®] Check procedure:

- 1 Connect the D.O. sensor to the meter.
- 2 Place the D.O. sensor in the check and storage beaker.



The sponge in the check and storage beaker must be moist (not wet). Leave the sensor in the check and storage beaker long enough so it can adapt to the ambient temperature.

- 3 In the measuring menu, start the FDO[®] Check procedure with *FDO Check / Start FDO Check*. The meter switches to the measured parameter, %.

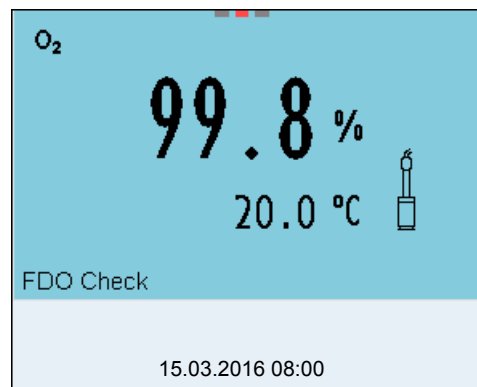

- 4 Start the measurement with **<ENTER>**. The measured value is checked for stability (stability control). The [AR] status indicator is displayed. The measured parameter flashes.
- 5 Wait for the AutoRead measurement to be completed (status indicator [HOLD][AR]) or accept the measured value with **<ENTER>**. The measured value is frozen.

- 6 Switch to the measured value display with **<M>**.
The check measurement is not documented.

7.2.4 Evaluation

The evaluation is based on the accuracy required by the used. Together with the nominal value (100 %) this results in a validity scope for the check.

If the measured value is within the validity scope, no cleaning or user calibration is required.

If the measured value is outside the validity scope, the sensor shaft and membrane should be cleaned, and the check should then be repeated (see section 5.4.1).

Example:

- Required accuracy: $\pm 2\%$.
- In water vapor-saturated air or air-saturated water, the nominal value for the relative D.O. saturation (abbreviated: saturation) is 100 %.
- Therefore, the validity scope is 98 ... 102 %
- The check resulted in a measured value of 99.3 %

The measurement error is within the specified validity scope.
No cleaning or user calibration is required.

7.3 Calibration

7.3.1 Why calibrate?

D.O. sensors age. This changes the slope of the D.O. sensor. Calibration determines the current slope of the sensor and stores this value in the instrument.



The FDO[®] 925 D.O. sensor ages so little it does not have to be regularly calibrated.

To detect changes of the sensor as early as possible, the FDO[®] Check procedure can be useful (see section 7.2).

7.3.2 When to calibrate?

- If your evaluation of the FDO[®] Check procedure suggests a calibration
- When the calibration interval has expired
- When your accuracy requirements are especially high
- Routinely within the framework of the company quality assurance

7.3.3 Calibration procedure

Calibration in water vapor-saturated air.

To calibrate the FDO[®] 925 use the calibration and storage beaker.

7.3.4 Calibration in water vapor-saturated air

Proceed as follows to calibrate the D.O. sensor:

- 1 Connect the D.O. sensor to the meter.
- 2 Place the FDO[®] 925 oxygen sensor in the check and storage beaker.



The sponge in the check and storage beaker must be moist (not wet). Leave the sensor in the check and storage beaker long enough so it can adapt to the ambient temperature.

- 3 Start the calibration with **<CAL>**.
The last calibration data (relative slope) is displayed.

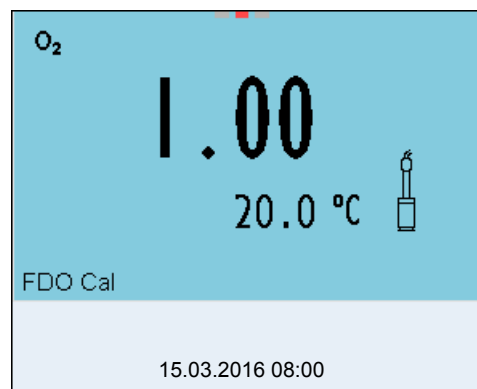

- 4 Start the measurement with **<ENTER>**.
The measured value is checked for stability (stability control).
The [AR] status indicator is displayed. The measured parameter flashes.
- 5 Wait for the AutoRead measurement to be completed (status indicator [HOLD][AR]) or
accept the calibration value with **<ENTER>**.
The calibration record is displayed and output to the interface.
- 6 Switch to the measured value display with **<ENTER>**.

Stability control (AutoRead)

In calibration, the Stability control function (AutoRead) is automatically activated.

7.3.5 Calibration data



The calibration record is automatically transmitted to the interface after calibrating.

Displaying the calibration record

The calibration data can be displayed and then output to the interface.

The calibration protocol of the last calibration is available in the menu *Calibration / Calibration record*. To open it in the measured value display, press the **<CAL_>** key.



The calibration records of the last 10 calibrations are available in the menu *Calibration / Calibration data storage / Display*. To open the *Calibration* menu in the measured value display, press the **<ENTER>** key.

Menu item	Setting/function	Explanation
<i>Calibration / Calibration data storage / Display</i>	-	Displays the calibration records. Further options: <ul style="list-style-type: none"> ● Scroll through the calibration records with <<>><>>. ● Output the displayed calibration record to the interface with <PRT>. ● Output all calibration records to the interface with <PRT_>. ● Quit the display with <ESC> or <ENTER>. ● Switch directly to the measured value display with <M>.
<i>Calibration / Calibration data storage / Output to USB flash drive or printer</i>	-	Outputs the stored calibration data to the USB-A interface (USB memory device/USB printer)
<i>Calibration / Calibration data storage / Output to RS232/USB</i>	-	Outputs the stored calibration data to the USB-B interface (PC)

Calibration evaluation

After calibrating, the meter automatically evaluates the current status of the calibration. The evaluation appears on the display and in the calibration record.

**Calibration
evaluation FDO[®] 925**

Display	Calibration record	Relative slope
	+++	S = 0.94 ... 1.06
	++	S = 0.92 ... 0.94 or S = 1.06 ... 1.08
	+	S = 0.90 ... 0.92 or S = 1.08 ... 1.10
<i>Error</i>	<i>Error</i>	S < 0.90 or S > 1.10
Perform error elimination according to chapter 14 WHAT TO DO IF...		

**Calibration record
(USB output)**

```

Multi 3620 IDS
Ser. no. 10139695

CALIBRATION Ox
Calibration date 15.03.2016 16:13:33
FDO 925
Ser. no. 10146858

SC-FDO 925           10158765
Relative slope       0.98
Sensor               +++

```

8 Conductivity

8.1 Measuring

8.1.1 Measuring the conductivity



The sensor connection and the USB-B (device) interface are galvanically insulated. This facilitates interference-free measurements also in the following cases:

- Measurement in grounded test samples
- Measurement with several sensors connected to one Multi 3620 IDS in one test sample

- 1 Connect an IDS conductivity sensor to the meter. The conductivity measuring window is displayed. The *Messzelle* and cell constant for the connected IDS conductivity sensor are automatically taken over.
- 2 Immerse the IDS conductivity sensor in the test sample.

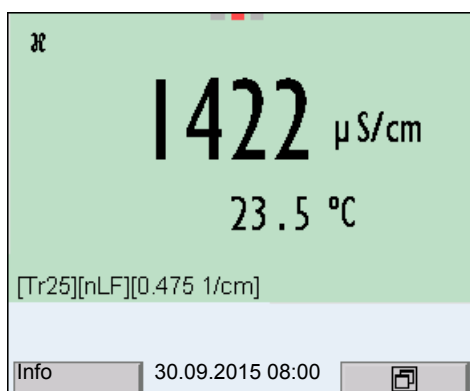

Selecting the displayed measured parameter

You can switch between the following displays with **<M>**:

- Conductivity [$\mu\text{S}/\text{cm}$] / [mS/cm]
- Resistivity [$\Omega\cdot\text{cm}$] / [$\text{k}\Omega\cdot\text{cm}$] / [$\text{M}\Omega\cdot\text{cm}$]
- Salinity SaL []
- Total dissolved solids TDS [mg/l] / [g/l]

The factor to calculate the total dissolved solids is set to 1.00 in the factory. You can adjust this factor to meet your requirements in the range 0.40 ... 1.00. The factor is set in the menu for the parameter TDS.

Freezes the measured value (HOLD function)

With the HOLD function, you can freeze the current measured value. The displayed measured value stops changing until you switch the HOLD function off.

- 1 Freeze the measured value with **<AR>**. The [HOLD] status indicator is displayed.



If the HOLD function is active, you can, e.g. start a manual measurement with stability control.

- 2 Release the frozen measured value again with **<AR>**.
The HOLD function is switched off.
The [HOLD] status display disappears.

Stability control (AutoRead)

The stability control function (*AutoRead*) continually checks the stability of the measurement signal. The stability has a considerable impact on the reproducibility of measured values. The display of the measured parameter flashes until a stable measured value is available.

You can start the *Stability control* function manually at any time, irrespective of the setting for automatic *Stability control* (see section 10.6.3) in the *System* menu.

- 1 Freeze the measured value with **<AR>**.
The [HOLD] status indicator is displayed.
- 2 Using **<ENTER>**, activate the *Stability control* function manually.
The [AR] status indicator appears while the measured value is assessed as not stable. A progress bar is displayed and the display of the measured parameter flashes.
The [HOLD][AR] status indicator appears as soon as a stable measured value is recognized. The progress bar disappears and the display of the measured parameter stops flashing.
The current measurement data is output to the interface. Measurement data meeting the stability control criterion is marked by AR.



You can prematurely terminate the *Stability control* function manually with **<ENTER>** at any time. If the *Stability control* function is prematurely terminated, the current measurement data are output to the interface without the AutoRead info.

- 3 Using **<ENTER>**, start a further measurement with *Stability control*.
or
Release the frozen measured value again with **<AR>**.
The display switches to the measured value display.
The [AR][HOLD] status display disappears.

Criteria for a stable measured value

The *Stability control* function checks whether the measured values are stable within the monitored time interval.

Measured parameter	Time interval	Stability in the time interval
Conductivity χ	10 seconds	Δ : better than 1.0% of measured value
Temperature	15 seconds	Δ : better than 0.5 °C

The minimum duration until a measured value is assessed as stable is the monitored time interval. The actual duration is mostly longer.

8.1.2 Measuring the temperature

For reproducible conductivity measurements, it is essential to measure the temperature of the test sample.

IDS sensors measure the temperature with a temperature sensor integrated in the IDS sensor.

8.2 Temperature compensation

The calculation of the temperature compensation is based on the preset reference temperature, 20 °C or 25 °C. It appears on the display as *Tr20* or *Tr25*.

You can select one of the following temperature compensation methods:

- **Nonlinear temperature compensation (*nLF*)** according to EN 27 888
- **Linear temperature compensation (*Lin*)** with adjustable coefficient in the range 0.000 ... 10.000 %/K
- No temperature compensation (off)



The reference temperature and temperature compensation are set in the menu for the parameter, conductivity (see section 10.4.1).

Application tips

Select the following temperature compensations given in the table according to the respective test sample:

Test sample	Temperature compensation	Display indicator
Natural water (ground water, surface water, drinking water)	<i>nLF</i> according to EN 27 888	<i>nLF</i>
Ultrapure water	<i>nLF</i> according to EN 27 888	<i>nLF</i>
Other aqueous solutions	<i>lin</i> Set linear temperature coefficient 0.001 ... 10.000 %/K	<i>lin</i>

Test sample	Temperature compensation	Display indicator
Salinity (sea-water)	Automatic <i>nLF</i> according to IOT (International Oceanographic Tables)	<i>Sal, nLF</i>

8.3 Calibration

8.3.1 Why calibrate?

Aging slightly changes the cell constant, e.g. due to coatings. As a result, an inexact measured value is displayed. The original characteristics of the cell can often be restored by cleaning the cell. Calibration determines the current value of the cell constant and stores this value in the meter. Thus, you should calibrate at regular intervals.

8.3.2 When to calibrate?

- After connecting a sensor
- Routinely within the framework of the company quality assurance
- When the cleaning interval has expired

8.3.3 Determining the cell constant (calibration in control standard)

You can determine the actual cell constant of the IDS conductivity sensor by calibrating with the control standard in the following range:

- 0.450 ... 0.500 cm⁻¹
(e.g. TetraCon 925, nominal cell constant 0.475)

The cell constant is determined in the control standard, 0.01 mol/l KCl.

In the default condition, the calibrated cell constant of the IDS sensor is set to 0.475 cm⁻¹ (IDS conductivity sensor TetraCon 925).

Stability control (AutoRead)

In calibration, the Stability control function (AutoRead) is automatically activated.

For this calibration procedure, the *Type* setting must be set to *cal*. Proceed as follows to determine the cell constant:

- 1 Connect an IDS conductivity sensor to the meter.
- 2 In the measured value display, select the conductivity parameter with **<M>**.
- 3 Start the calibration with **<CAL>**.
The cell constant that was calibrated last is displayed.

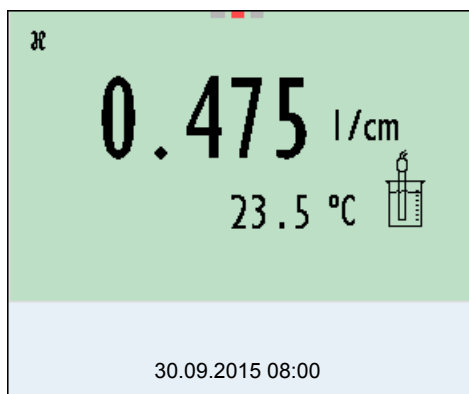

- 4 Immerse the IDS conductivity sensor in the control standard solution, 0.01 mol/l KCl.
- 5 Start the measurement with **<ENTER>**.
The measured value is checked for stability (stability control).
The [AR] status indicator is displayed. The measured parameter flashes.
- 6 Wait for the measurement with stability control to be completed (status indicator [HOLD][AR]) or
accept the calibration value with **<ENTER>**.
The calibration record is displayed and output to the interface.
- 7 Switch to the measured value display with **<ENTER>**.

8.3.4 Calibration data



The calibration record is automatically transmitted to the interface after calibrating.

The calibration data can be displayed and then output to the interface.

Displaying the calibration record

The calibration protocol of the last calibration is available in the menu *Calibration / Calibration record*. To open it in the measured value display, press the **<CAL_>** key.

The calibration records of the last 10 calibrations are available in the menu *Calibration / Calibration data storage / Display*. To open the *Calibration* menu in the measured value display, press the **<ENTER>** key.

Menu item	Setting/function	Explanation
<i>Calibration / Calibration data storage / Display</i>	-	Displays the calibration records. Further options: <ul style="list-style-type: none"> ● Scroll through the calibration records with <◀><▶>. ● Output the displayed calibration record to the interface with <PRT>. ● Output all calibration records to the interface with <PRT_>. ● Quit the display with <ESC> or <ENTER>. ● Switch directly to the measured value display with <M>.
<i>Calibration / Calibration data storage / Output to USB flash drive or printer</i>	-	Outputs the stored calibration data to the USB-A interface (USB memory device/USB printer)
<i>Calibration / Calibration data storage / Output to RS232/USB</i>	-	Outputs the stored calibration data to the USB-B interface (PC)

Calibration evaluation

After calibration, the meter automatically evaluates the current status of the calibration. The evaluation appears on the display and in the calibration record.

Display	Calibration record	Cell constant [cm ⁻¹]
	+++	Within the range 0.450 ... 0.500 cm ⁻¹
<i>Error</i>	<i>Error</i>	Outside the range 0.450 ... 0.500 cm ⁻¹ Eliminate the error according to chapter 14 WHAT TO DO IF...

**Calibration record
(USB output)**

Multi 3620 IDS
Ser. no. 09250023

CALIBRATION Cond
Calibration date 15.03.2016 16:13:33
TetraCon 925
Ser. no. 09250033

Cell constant 0.476 1/cm 25.0 °C
Sensor +++

9 Turbidity measurement (VisoTurb® 900-P)

9.1 Measuring

9.1.1 Measuring the turbidity



The sensor connection and the USB-B (device) interface are galvanically insulated. This facilitates interference-free measurements also in the following cases:

- Measurement in grounded test samples
- Measurement with several sensors connected to one Multi 3620 IDS in one test sample

Preparatory activities

Perform the following preparatory activities when you want to measure:

- Avoid gas bubbles (e.g. air bubbles) in the test sample.
- Use suitable vessels for measurement and calibration (see operating manual of the VisoTurb® 900-P sensor).
- Heed the minimum depth of immersion for the sensor

- 1 Connect a turbidity sensor to the measuring instrument. The turbidity measuring screen is displayed. The data for the connected IDS turbidity sensor are automatically taken over.
- 2 Fill the test sample into a lightproof measuring beaker up to a level of at least 6 cm.
- 3 When immersing the sensor in the test sample, hold the sensor at an angle.
- 4 For measuring, position the sensor upright.
- 5 Position the sensor in a way that meets the following requirements.
 - Distance to the bottom: 6 cm
 - Distance to the walls of the beaker: 2 cm
 - Minimum depth of immersion: 2 cm



To position the sensor optimally and permanently while it is measuring, fix it on a support.

Measuring

You can carry out turbidity measurements as follows:

- 1 Perform the preparatory activities.

- 2 Immerse the sensor in the test sample at an angle and then position it in the measuring container.

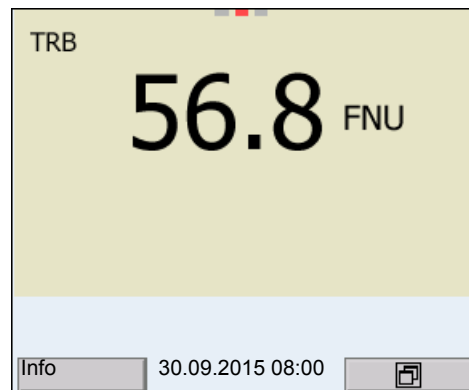

Selecting the displayed measured parameter

You can switch between the following displays with **<M>**:

- Turbidity [FNU]
- Turbidity [NTU]

Freezes the measured value (HOLD function)

With the HOLD function, you can freeze the current measured value. The displayed measured value stops changing until you switch the HOLD function off.

- 1 Freeze the measured value with **<AR>**.
The [HOLD] status indicator is displayed.



If the HOLD function is active, you can, e.g. start a manual measurement with stability control.

- 2 Release the frozen measured value again with **<AR>**.
The HOLD function is switched off.
The [HOLD] status display disappears.

Stability control (AutoRead)

The stability control function (*AutoRead*) continually checks the stability of the measurement signal. The stability has a considerable impact on the reproducibility of measured values. The display of the measured parameter flashes until a stable measured value is available.

You can start the *Stability control* function manually at any time, irrespective of the setting for automatic *Stability control* (see section 10.6.3) in the *System* menu.

- 1 Freeze the measured value with **<AR>**.
The [HOLD] status indicator is displayed.

- 2 Using **<ENTER>**, activate the *Stability control* function manually. The [AR] status indicator appears while the measured value is assessed as not stable. A progress bar is displayed and the display of the measured parameter flashes. The [HOLD][AR] status indicator appears as soon as a stable measured value is recognized. The progress bar disappears and the display of the measured parameter stops flashing. The current measurement data is output to the interface. Measurement data meeting the stability control criterion is marked by AR.



You can prematurely terminate the *Stability control* function manually with **<ENTER>** at any time. If the *Stability control* function is prematurely terminated, the current measurement data are output to the interface without the AutoRead info.

- 3 Using **<ENTER>**, start a further measurement with *Stability control*.
or
Release the frozen measured value again with **<AR>**.
The display switches to the measured value display.
The [AR][HOLD] status display disappears.

Criteria for a stable measured value

The *Stability control* function checks whether the measured values are stable within the monitored time interval.

Measured parameter	Time interval	Stability in the time interval
Turbidity (FNU/NTU)	15 seconds	Δ : better than 1.0% of measured value

The minimum duration until a measured value is assessed as stable is the monitored time interval. The actual duration is mostly longer.

9.2 Calibration

9.2.1 Why calibrate?

The calibration line of the sensor is determined and stored through calibrating.

9.2.2 When to calibrate?

- When the calibration interval has expired
- At regular intervals

9.2.3 Calibration standards

Calibrate with 1 to 3 turbidity standard solutions. The standard solutions must be selected in the following order.

Standard solution	Range (FNU/NTU)
1	0.0 ... 1.0
2	5.0 ... 200.0
3	200.0 ... 4000.0

The turbidity expected in the measurement dictates the number and selection of the standards. Calibration has to be carried out for the range with the highest turbidity to be expected and for all lower ranges. The standard solutions for this have to be selected in ascending order, starting with standard 1.

Example: If you expect turbidity values in the range 200 ... 4000 FNU/NTU, you have to carry out a 3-point calibration.

The measurement precision is also dependent on the selected standard solutions. Therefore, the selected standard solutions should cover the value range expected of the turbidity measurement.

If the measured turbidity is outside the measurement range, OFL is displayed.



As the standard with turbidity value 0.0 FNU you can use clean tap water or filtered, deionized water in a suitable calibration vessel, depending on the required quality (see operating manual of the sensor VisoTurb® 900-P). This standard should be freshly prepared prior to every calibration. Suitable bottles are listed in the price list of the WTW catalog "Lab and field instrumentation".

Standards with turbidity values for the calibration ranges 2 and 3 are available as accessories (see price list of the WTW catalog "Lab and field instrumentation"). Calibration can be carried out in the bottles the standards are delivered in. The standards can be used several times within their shelf life.

Replace the standards solutions if you have any doubts concerning their quality or after the expiration date.

9.2.4 Carry out calibration

- 1 Perform the preparatory activities.
- 2 Connect the turbidity sensor to the measuring instrument. The turbidity measuring screen is displayed.
- 3 Keep the standard solutions ready in suitable calibration vessels.
- 4 In the measured value display, select the TRB measuring window with <▲> <▼> and <M>.

- 5 Start the calibration with **<CAL>**.
The calibration display appears.

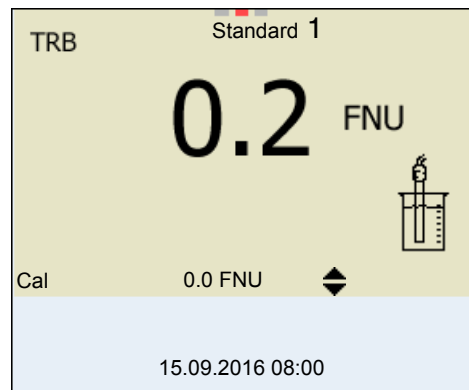

- 6 Thoroughly rinse the turbidity sensor with distilled water and dry it with a lint-free cloth.
- 7 Immerse the turbidity sensor in the test sample at an angle.
- 8 Position the turbidity sensor in the measuring vessel.
- 9 Use **<▲>** **<▼>** and **<◀><▶>** to set the concentration of the standard solution for each digit and confirm with **<ENTER>**.
The standard solution is measured.
The measured value is checked for stability (AutoRead).
- 10 Wait for the end of the AutoRead measurement.
The calibration display for the next standard solution appears.

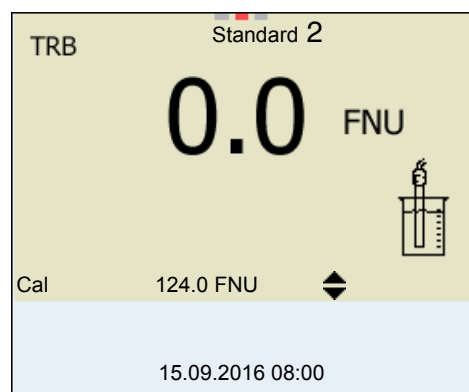

Continuing with two-point calibration

- 11 Thoroughly rinse the turbidity sensor with distilled water and dry it with a lint-free cloth.
- 12 Immerse the turbidity sensor in the test sample at an angle.
- 13 Position the turbidity sensor in the measuring vessel.

- 14 Use <▲> <▼> and <◀><▶> to set the concentration of the standard solution for each digit and confirm with <ENTER>. The standard solution is measured. The measured value is checked for stability (AutoRead).
- 15 Wait for the end of the AutoRead measurement. The calibration display for the next standard solution appears.

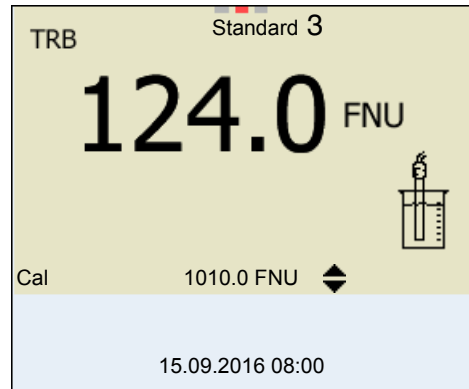

- 16 If necessary, terminate the calibration as a two-point calibration with <M>. The new calibration values are displayed. or Continue with three-point calibration.

Continuing with three-point calibration

Repeat the steps 11 to 15 with the third standard solution. The new calibration values are displayed after the last calibration step was completed.

9.2.5 Calibration data

Displays the calibration data



Calibration The calibration protocol of the last calibration is available in the menu <ENTER> / *Calibration record*. To open it in the measured value display, press the <CAL_> key.

The calibration records of the last 10 calibrations are available in the menu *Calibration* / *Calibration data storage* / *Display*. To open the *Calibration* menu in the measured value display, press the <ENTER> key.

Menu item	Setting/ function	Explanation
<i>Calibration / Calibration data storage / Display</i>	-	Displays the calibration record. Further options: <ul style="list-style-type: none"> ● Scroll through the calibration records with <<<>>>. ● Output the displayed calibration record to the interface with <PRT>. ● Output all calibration records to the interface with <PRT_>. ● Quit the display with <ESC> or <ENTER>. ● Switch directly to the measured value display with <M>.
<i>Calibration / Calibration data storage / Output to RS232/USB</i>	-	Outputs the calibration records to the interface.

Calibration evaluation

After calibrating, the meter automatically evaluates the calibration.

Display	Calibration record	Explanation
	+++	Optimum calibration
		Good calibration

Calibration record (USB output)

```
Multi 3620 IDS
Ser. no. 12345678

CALIBRATION TRB:
VisoTurb 900-P
Ser. no. 14E999003
18.09.2016 08:09:10

# 1          0.0 FNU
# 2          124.0 FNU
Sensor      +++
_____
```

10 Settings

10.1 pH measurement settings

10.1.1 Settings for pH measurements

The settings are made in the menu for calibration and measurement settings of the pH/ORP measurement. To open the settings, display the required measured parameter in the measured value display and press the **<ENTER>** key. After completing the settings, switch to the measured value display with **<M>**. Default settings are printed in **bold**.

Menu item	Possible setting	Explanation
<i>Calibration / Calibration record</i>	-	Displays the calibration record of the last calibration.
<i>Calibration / Calibration data storage / Display</i>	-	Displays the last calibration records (max. 10)
<i>Calibration / Calibration data storage / Output to USB flash drive or printer</i>	-	Outputs the stored calibration data to the USB-A interface (USB memory device/USB printer)
<i>Calibration / Calibration data storage / Output to RS232/USB</i>	-	Outputs the stored calibration data to the USB-B interface (PC)
<i>Calibration / Buffer</i>	TEC NIST/DIN ConCal ...	Buffer sets to be used for pH calibration. More buffers and details, see section 5.2.
<i>Calibration / Single-point calibration</i>	yes no	Quick calibration with 1 buffer
<i>Calibration / Calibration interval</i>	1 ... 7 ... 999 d	<i>Calibration interval</i> for the IDS-pH sensor (in days). The meter reminds you to calibrate regularly by the flashing sensor symbol in the measuring screen.
<i>Calibration / Unit for slope</i>	mV/pH %	Unit of the slope. The % display refers to the Nernst slope of -59.2 mV/pH (100 x determined slope/Nernst slope).
<i>QSC / First calibration</i>	-	Starts the initial calibration with QSC buffers. This menu item is only available as long as no initial calibration was carried out with the connected IDS sensor.
<i>QSC / Record of first calibration</i>	-	Displays the calibration record of the QSC initial calibration.

Menu item	Possible setting	Explanation
<i>QSC / Control calibration</i>	-	Starts the control calibration with QSC buffers. This menu item is only available if an initial calibration was carried out with the connected IDS sensor.
<i>Man. temperature</i>	-25... +25... +130 °C	Entry of the manually determined temperature. This menu item is only available if an IDS adapter is connected. This menu item is only available if an IDS sensor without temperature sensor is connected.
<i>Alternative temperature</i>	<i>on</i> <i>off</i>	Takes over the temperature value from an IDS sensor. This menu item is only available if an IDS adapter and an IDS sensor with integrated temperature sensor are connected.
<i>pH resolution</i>	0.001 0.01 0.1	Resolution of the pH display
<i>mV resolution</i>	0.1 1	Resolution of the mV display
<i>Reset</i>	-	Resets all sensor settings to the delivery condition (see section 10.7.1).

10.1.2 Buffer sets for calibration

You can use the buffer sets quoted in the table for an automatic calibration. The pH values are valid for the specified temperature values. The temperature dependence of the pH values is taken into consideration during calibration.

No.	Buffer set *	pH values	at
1	ConCal	Any	Any
2	<i>NIST/DIN</i> DIN buffers according to DIN 19266 and NIST Traceable Buffers	1.679 4.006 6.865 9.180 12.454	25 °C
3	<i>TEC</i> WTW Technical buffers	2.000 4.010 7.000 10.011	25 °C
4	<i>Merck 1*</i>	4.000 7.000 9.000	20 °C

No.	Buffer set *	pH values	at
5	<i>Merck 2 *</i>	1.000 6.000 8.000 13.000	20 °C
6	<i>Merck 3 *</i>	4.660 6.880 9.220	20 °C
7	<i>Merck 4 *</i>	2.000 4.000 7.000 10.000	20 °C
8	<i>Merck 5 *</i>	4.010 7.000 10.000	25 °C
9	<i>DIN 19267</i>	1.090 4.650 6.790 9.230	25 °C
10	<i>Mettler Toledo USA *</i>	1.679 4.003 7.002 10.013	25 °C
11	<i>Mettler Toledo EU *</i>	1.995 4.005 7.002 9.208	25 °C
12	<i>Fisher *</i>	2.007 4.002 7.004 10.002	25 °C
13	<i>Fluka BS *</i>	4.006 6.984 8.957	25 °C
14	<i>Radiometer *</i>	1.678 4.005 7.000 9.180	25 °C
15	<i>Baker *</i>	4.006 6.991 10.008	25 °C
16	<i>Metrohm *</i>	3.996 7.003 8.999	25 °C

No.	Buffer set *	pH values	at
17	<i>Beckman</i> *	4.005 7.005 10.013	25 °C
18	<i>Hamilton Duracal</i> *	4.005 7.002 10.013	25 °C
19	<i>Precisa</i> *	3.996 7.003 8.999	25 °C
20	<i>Reagecon TEC</i> *	2.000 4.010 7.000 10.000	25 °C
21	<i>Reagecon 20</i> *	2.000 4.000 7.000 10.000 13.000	20 °C
22	<i>Reagecon 25</i> *	2.000 4.000 7.000 10.000 13.000	25 °C
23	<i>Chemsolute</i> *	2.000 4.000 7.000 10.000	20 °C
24	<i>USABlueBook</i> *	4.000 7.000 10.000	25 °C
25	<i>YSI</i> *	4.000 7.000 10.000	25 °C

Brand names or trade names are trademarks of their respective owners protected by law.

10.1.3 Calibration interval

The calibration evaluation is displayed as a sensor symbol.

After the QSC function has been enabled the sensor symbol is replaced by the QSC color scale (see section 5.4).

After the specified calibration interval has expired, the sensor symbol or the QSC color scale flashes. It is still possible to measure.



To ensure the high measuring accuracy of the measuring system, calibrate after the calibration interval has expired.

Setting the calibration interval

The calibration interval is set to 7 days (d7) in the factory. You can change the interval (1 ... 999 days):

- 1 Open the menu for measurement settings with **<ENTER>**.
- 2 In the *Calibration / Calibration interval* menu, set the calibration interval with **<▲><▼>**.
- 3 Confirm the setting with **<ENTER>**.
- 4 Quit the menu with **<M>**.

10.2 ORP measurement settings

10.2.1 Settings for ORP measurements

The settings are made in the menu for measurement settings of the ORP measurement. To open the settings, display the required measured parameter in the measured value display and press the **<ENTER>** key. After completing the settings, switch to the measured value display with **<M>**. Default settings are printed in **bold**.

Menu item	Possible setting	Explanation
<i>mV resolution</i>	0.1 1	Resolution of the mV display
<i>Reset</i>	-	Resets all sensor settings to the delivery condition (see section 10.7.1).

10.3 D.O. measurement settings

10.3.1 Settings for D.O. sensors

The settings are available in the menu for measurement and calibration settings. To open the settings, display the required measured parameter in the measured value display and press the **<ENTER>** key. After completing the settings, switch to the measured value display with **<M>**.

Menu item	Possible setting	Explanation
<i>Calibration / Calibration record</i>	-	Displays the calibration record of the last calibration.
<i>Calibration / Calibration data storage / Display</i>	-	Displays the last calibration records (max. 10)
<i>Calibration / Calibration data storage / Output to USB flash drive or printer</i>	-	Outputs the stored calibration data to the USB-A interface (USB memory device/USB printer)
<i>Calibration / Calibration data storage / Output to RS232/USB</i>	-	Outputs the stored calibration data to the USB-B interface (PC)
<i>Calibration / Calibration interval</i>	1 ... 180 ... 999 d	<i>Calibration interval</i> for the D.O. sensor (in days). The meter reminds you to calibrate regularly by the flashing sensor symbol in the measuring screen.
<i>FDO Check / Start FDO Check</i>	-	Starts the FDO [®] check procedure
<i>FDO Check / Check interval</i>	1 ... 60 ... 999 d	Interval for the <i>FDO Check</i> (in days). The meter reminds you to check the sensor regularly by <i>FDO Check</i> status indicator in the measuring screen.
<i>Sal automatic</i>	<i>on</i> <i>off</i>	Automatic salt content correction for concentration measurements. The measured salinity value is taken over by a connected conductivity sensor. This menu item is only available if an IDS conductivity sensor is connected.
<i>Sal correction</i>	<i>on</i> <i>off</i>	Manual salt content correction for concentration measurements.

Menu item	Possible setting	Explanation
<i>Salinity</i>	0.0 ... 70.0	Salinity or salinity equivalent for the salt content correction. This menu item is only available if the automatic salt content correction is switched off and the manual salt content correction is switched on.
<i>Response time t90</i>	30 ... 300	Response time of the signal filter (in seconds). A signal filter in the sensor reduces the limits of variation of the measured value. The signal filter is characterized by the response time t90. This is the time after which 90 % of a signal change is displayed. This menu item is only available if sensor and meter support this function. You can update the firmware of sensor and meter (see chapter 16).
<i>Reset</i>	-	Resets all sensor settings to the delivery condition (see section 10.7.1).

10.4 Cond measurement settings

10.4.1 Settings for IDS conductivity sensors

The settings are made in the menu for the measured parameter, conductivity. To open the settings, display the required measured parameter in the measured value display and press the **<ENTER>** key. After completing the settings, switch to the measured value display with **<M>**.

The possible settings are individually displayed for each sensor. Below the setting menu is displayed for two IDS sensors (TetraCon 925, LR 925/01). Default settings are printed in **bold**.

Setting
menuTetraCon 925

Menu item	Possible setting	Explanation
<i>Calibration / Calibration record</i>	-	Displays the calibration record of the last calibration.
<i>Calibration / Calibration data storage / Display</i>	-	Displays the last calibration records (max. 10)
<i>Calibration / Calibration data storage / Output to USB flash drive or printer</i>	-	Outputs the stored calibration data to a connected USB memory device/ USB printer)
<i>Calibration / Calibration data storage / Output to RS232/USB</i>	-	Outputs the calibration data storage to the interface
<i>Calibration / Calibration interval</i>	1 ... 150 ... 999 d	<i>Calibration interval</i> for the IDS conductivity sensor (in days). The meter reminds you to calibrate regularly by the flashing sensor symbol in the measuring screen.
<i>Type</i>	<i>Cal</i> <i>man</i>	Measuring cell used Measuring cells whose cell constant is determined by calibration in the KCL control standard solution. Calibration range: 0.450 to 0.500 cm ⁻¹ The currently valid cell constant is displayed in the status line. Freely adjustable cell constant in the range 0.450 ... 0.500 cm ⁻¹ .
<i>Man. cell const.</i>	0.450 ... 0.475 ... 0.500 cm⁻¹	Display and setting options for the cell constant.
<i>Temp. comp. (TC) / Method</i>	nLF <i>Lin</i> <i>off</i>	Procedure for temperature compensation (see section 8.2). This setting is only available for the measured parameters, x and p.
<i>Temp. comp. (TC) / Linear coeff.</i>	0.000 ... 2.000 ... 10.000 %/K	Coefficient of the linear temperature compensation. This menu item is only available when the linear temperature compensation is set.

Menu item	Possible setting	Explanation
<i>Temp. comp. (TC) / Reference temp.</i>	20 °C 25 °C	Reference temperature This setting is only available for the measured parameters, χ and ρ .
<i>TDS factor</i>	0.40 ... 1.00	Factor for TDS value
<i>Reset</i>	-	Resets all sensor settings to the delivery condition (see section 10.7.1).

Setting menu
LR 925/01

Menu item	Possible setting	Explanation
<i>Cell constant</i>	0.090 ... 0.100 ... 0.110 cm ⁻¹	Display and setting options for the cell constant
<i>Temp. comp. (TC) / Method</i>	nLF Lin off	Procedure for temperature compensation (see section 8.2). This setting is only available for the measured parameters, χ and ρ .
<i>Temp. comp. (TC) / Linear coeff.</i>	0.000 ... 2.000 ... 10.000 %/K	Coefficient of the linear temperature compensation. This menu item is only available when the linear temperature compensation is set.
<i>Temp. comp. (TC) / Reference temp.</i>	20 °C 25 °C	Reference temperature This setting is only available for the measured parameters, χ and ρ .
<i>TDS factor</i>	0.40 ... 1.00	Factor for TDS value
<i>Reset</i>	-	Resets all sensor settings to the delivery condition (see section 10.7.1).

10.5 Turb measurement settings

10.5.1 Settings for turbidity sensors

The settings are made in the menu for the measured parameter, turbidity. To open the settings, display the required measured parameter in the measured value display and press the **<ENTER>** key. After completing the settings, switch to the measured value display with **<M>**.

The possible settings are individually displayed for each sensor. Default settings are printed in **bold**.

Setting menu of the
VisoTurb® 900-P

Menu item	Possible setting	Explanation
<i>Calibration / Calibration record</i>	-	Displays the calibration record of the last calibration.
<i>Calibration / Calibration data storage / Display</i>	-	Displays the last calibration records (max. 10)
<i>Calibration / Calibration data storage / Output to USB flash drive or printer</i>	-	Outputs the stored calibration data to a connected USB memory device/ USB printer)
<i>Calibration / Calibration data storage / Output to RS232/USB</i>	-	Outputs the calibration data storage to the interface
<i>Calibration / Calibration interval</i>	1 ... 30 ... 999 d	<i>Calibration interval</i> for the turbidity sensor (in days). The meter reminds you to calibrate regularly by the flashing sensor symbol in the measuring screen.
<i>Auflösung</i>	0.1 1	Resolution of the FNU/NTU display
<i>Reset</i>	-	Resets all sensor settings to the delivery condition (see section 10.7.1).

10.6 Sensor-independent settings**10.6.1 System**

To open the *Storage & config* menu, press the **<ENTER_>** key in the measured value display. After completing the settings, switch to the measured value display with **<M>**.

Default settings are printed in **bold**.

Menu item	Setting	Explanation
<i>System / General / Language</i>	<i>Deutsch</i> English (more)	Selects the menu language
<i>System / General / Acoustic signal</i>	on off	Switches on/off the beep on keystroke
<i>System / General / Illumination</i>	Auto on	Switches the display illumination on/off

Menu item	Setting	Explanation
<i>System / General / Brightness</i>	0 ... 15 ... 22	Changes the display brightness
<i>System / General / Switchoff time</i>	10 min ... 1h ... 24 h	Adjusts the switch-off time
<i>System / General / Temperature unit</i>	°C °F	Temperature unit, degrees Celsius or degrees Fahrenheit. All temperature values are displayed with the selected unit.
<i>System / General / Stability control</i>	on off	Switches on or off the automatic stability control during measurement (see section 10.6.3)
<i>System / Interface / Baud rate</i>	1200, 2400, 4800 , 9600, 19200	Baud rate of the USB device interface
<i>System / Interface / Output format</i>	ASCII CSV	Output format for data transmission For details, see section 12
<i>System / Interface / Decimal separator</i>	Dot (xx.x) Comma (xx,x)	Decimal separator
<i>System / Interface / Output header</i>		Output of a header for <i>Output format</i> : CSV
<i>System / Interface / Extended Oxi output</i>		The measured values for the parameters concentration (mg/l) and saturation (%) are output together. The function is active if the following requirements are met: <ul style="list-style-type: none"> ● a D.O. sensor is connected ● The D.O. sensor displays the parameter concentration (mg/l) or saturation (%) ● the <i>Output format CSV</i> is set
<i>System / Clock function</i>	<i>Date format</i> <i>Datum</i> <i>Time</i>	Settings of time and date. For details, see section 4.5.5
<i>System / Service information</i>		Hardware version and software version of the meter are displayed.
<i>System / Reset</i>	-	Resets the system settings to the default values. For details, see section 10.7.2

10.6.2 Data storage

This menu contains all functions to display, edit and erase stored measured values.



Detailed information on the memory functions of the Multi 3620 IDS is given in section 11.

10.6.3 Automatic *Stability control*

The automatic *Stability control* (AutoRead) function continuously checks the stability of the measurement signal. The stability has a considerable impact on the reproducibility of measured values.

You can activate or switch off the automatic *Stability control* function (see section 10.6).

The measured parameter flashes on the display

- as soon as the measured value is outside the stability range
- when you switch over between the measured parameters with <M>.
- when the automatic *Stability control* is switched off.

10.6.4 Automatic switch-off function

The instrument has an automatic switchoff function in order to save the batteries (see section 10.6.1). The automatic switch-off function switches off the meter if no key is pressed for an adjustable period.

The automatic switch-off function is not active

- if the power pack is connected
- if a USB-B cable is connected
- if the *Automatic data storage function is active, or with automatic data transmission*

10.6.5 Display illumination

The meter automatically switches the display illumination to energy saving mode if no key is pressed for 20 seconds.

The illumination is switched on with the next keystroke again.

You can also generally switch on the display illumination (see section 10.6.1).

10.7 Reset

You can reset (initialize) all sensor settings and sensor-independent settings separately from each other.

10.7.1 Resetting the measurement settings



The calibration data are reset to the default settings together with the measuring parameters. Recalibrate after performing a reset.

pH The following settings for pH measurements are reset to the default settings with the *Reset* function:

Setting	Default settings
Buffer	AutoCalTEC
Calibration interval	7 d
Unit for slope	mV/pH
Measured parameter	pH
pH resolution	0.001
mV resolution	0.1
Asymmetry	0 mV
Slope	-59.2 mV
Man. temperature	25 °C
Single-point calibration	off

The sensor settings are reset under the *Reset* menu item in the menu for calibration and measurement settings. To open the settings, display the required measured parameter in the measured value display and press the **<ENTER>** key.

ORP The following settings for ORP measurements are reset to the default settings with the *Reset* function:

Setting	Default settings
mV resolution	0.1
Man. temperature	25 °C

The sensor settings are reset under the *Reset* menu item in the menu for calibration and measurement settings. To open the settings, display the required measured parameter in the measured value display and press the **<ENTER>** key.

Dissolved oxygen The following settings for D.O. measurements are reset to the default settings with the *Reset* function:

Setting	Default settings
Calibration interval	180 d
Check interval	60 d
Measured parameter	D.O. concentration
Relative slope (S_{Rel})	1.00
Salinity (value)	0.0
Salinity (function)	Off

The sensor settings are reset under the *Reset* menu item in the menu for calibration and measurement settings. To open the settings, display the required measured parameter in the measured value display and press the **<ENTER>** key.

Conductivity

The following settings for conductivity measurements are reset to the default settings with the *Reset* function:

Setting	Default settings
Calibration interval	150 d
Measured parameter	χ
Cell constant (c)	Depending on the connected measuring cell: 0.475 cm ⁻¹ (calibrated) 0.475 cm ⁻¹ (set) 0.100 cm ⁻¹
Temperature compensation	nLF
Reference temperature	25 °C
Temperature coefficient (TC) of the linear temperature compensation	2.000 %/K
TDS factor	1.00

The sensor settings are reset under the *Reset* menu item in the menu for calibration and measurement settings. To open the settings, display the required measured parameter in the measured value display and press the **<ENTER>** key.

Turbidity

The following settings for the turbidity measurement are reset to the default condition with the *Reset* function:

Setting	Default settings
Calibration interval	30 d
Measured parameter	FNU
Auflösung	0.1

The sensor settings are reset under the *Reset* menu item in the menu for calibration and measurement settings. To open the settings, display the required measured parameter in the measured value display and press the **<ENTER>** key.

10.7.2 Resetting the system settings

The following system settings can be reset to the default status:

Setting	Default settings
<i>Language</i>	English
<i>Acoustic signal</i>	on
<i>Baud rate</i>	4800 Baud
<i>Output format</i>	ASCII
<i>Decimal separator</i>	.
<i>Brightness</i>	15
<i>Illumination</i>	Auto
<i>Switchoff time</i>	1 h
<i>Temperature unit</i>	°C
<i>Stability control</i>	on

The resetting of the system settings is done in the menu *Storage & config / System / Reset*. To open the menu *Storage & config* in the measured value display, press the **<ENTER_>** key.

11 Data memory

You can transmit measured values (datasets) to the data memory:

- Manual storage (see section 11.1)
- Automatic storing at intervals (see section 11.2)

Each data storing process transmits the current dataset to the interface at the same time.

11.1 Manual storage

You can store a measurement dataset to the data memory as follows. The dataset is at the same time output to the interface:

- 1 Press the **<STO>** key shortly.
The menu for manual data storage appears.

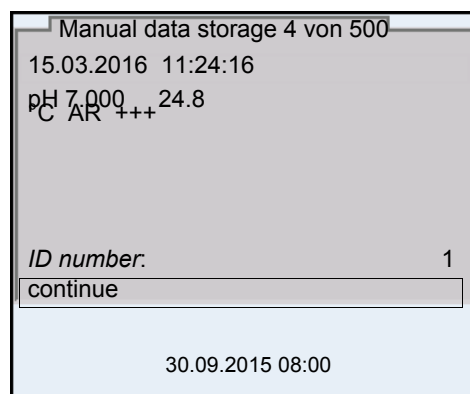

- 2 If necessary, change and confirm the ID number (1 ... 10000) with **<▲>****<▼>** and **<ENTER>**.
The dataset is stored. The meter switches to the measured value display.

If the memory is full

When all storage locations are occupied, it is not possible to continue storing. Then you can e.g. transmit the stored data to a PC or a USB flash drive (see section 11.3.1) and subsequently erase the storage (see section 11.3.2).

11.2 Automatic data storage at intervals

The storing interval (*Interval*) determines the time interval between automatic data storing processes. Each data storing process transmits the current dataset to the interface at the same time.

Configuring the automatic memory function

- 1 Press the **<STO_>** key.
The menu for automatic data storing appears.

The screenshot shows the 'Automatic data stor-' menu with the following settings and graphical elements:

- ID number:** 1
- Interval:** 30 s
- Duration:** 180 min
- continue** button
- Graphical display:** A bar chart showing memory usage. The current usage is 0d03h00min (3 hours). The maximum available duration is 1d17h33mi (1 day 17 hours 33 minutes).
- Date and Time:** 30.09.2015 08:00

Annotations in the image:

- 1:** Points to the 'Duration' setting (180 min).
- 2:** Points to the 'continue' button.
- 3:** Points to the graphical display of memory usage.

1 Specified entire storing duration
2 Max. available storing duration
3 Graphical display of the memory usage

Settings You can configure the automatic data storing function with the following settings:

Menu item	Possible setting	Explanation
<i>ID number</i>	1 ... 10000	ID number for the dataset series.
<i>Interval</i>	1 s, 5 s, 10 s, 30 s, 1 min, 5 min, 10 min, 15 min, 30 min, 60 min	Storing interval. The lower limit of the storing interval can be restricted by the number of free memory locations. The upper limit is restricted by the storing duration.
<i>Duration</i>	1 min ... x min	Storing duration. Specifies after which time the automatic data storing should be terminated. The lower limit of the storage duration is restricted by the storage interval. The upper limit is restricted by the number of free memory locations.

Starting the automatic storing function

To start the automatic storing function, select *continue* with **<▲><▼>** and confirm with **<ENTER>**. The meter switches to the measured value display.

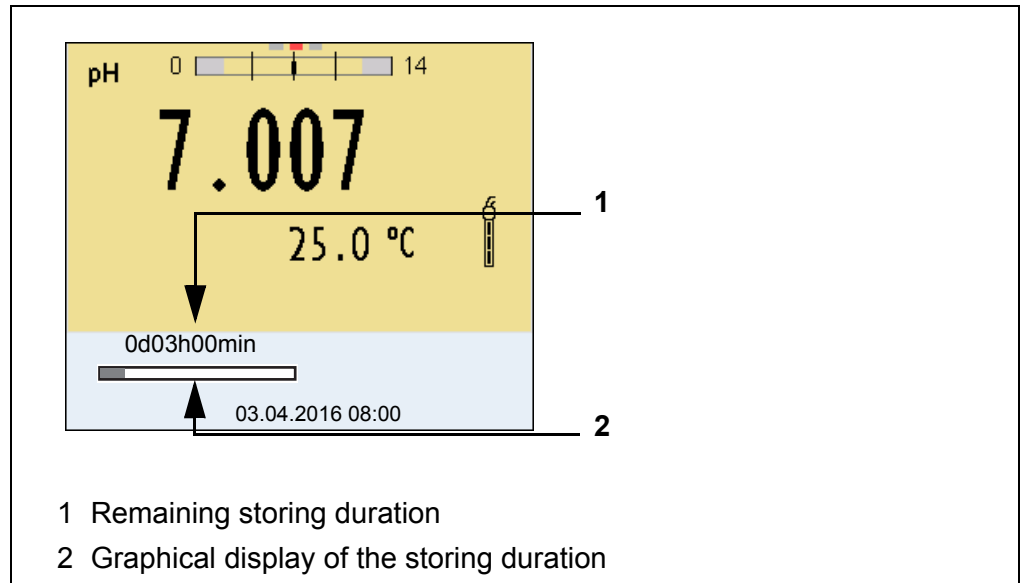

The active automatic data storing function can be recognized by the progress bar in the status line. The progress bar indicates the remaining storage duration.



If the automatic data storage function is activated, only the following keys are active: **<M><STO_>** and **<On/Off>**. The other keys and the automatic switch-off function are deactivated.

Terminating the automatic storage function prematurely

Proceed as follows to switch off the automatic data storing function before the adjusted storing duration has expired:

- 1 Press the **<STO_>** key.
The following window appears.

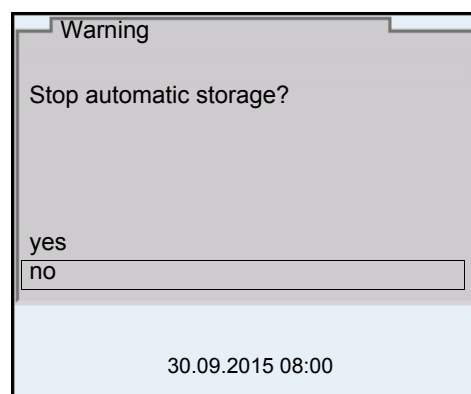

- 2 Using **<▲><▼>**, select *yes* and confirm with **<ENTER>**.
The meter switches to the measured value display.
The automatic data storing function is terminated.

11.3 Measurement data memory

11.3.1 Editing the measurement data memory

The contents of the manual or automatic measurement data storage can be shown on the display.

Each of the measurement data memories has a function to erase the entire contents.

Editing the data memory

The memory is edited in the menu, *Storage & config/ Data storage*. To open the *Storage & config* menu, press the **<ENTER_>** key in the measured value display.

Open the manual or automatic storage directly with the **<RCL>** or **<RCL_>** key.



The settings are explained here using the manual data memory as an example. The same settings and functions are available for the automatic data memory.

Settings

Menu item	Setting/ function	Explanation
<i>Data storage / Manual data storage / Display</i>	-	Displays all measurement datasets page by page. Further options: <ul style="list-style-type: none"> ● Scroll through the datasets with <<>>. ● Output the displayed dataset to the interface with <PRT>. ● Quit the display with <ESC>.
<i>Data storage / Manual data storage / Output to USB flash drive or printer</i>	-	Outputs all stored measurement data to a connected USB flash drive / USB printer.
<i>Data storage / Manual data storage / Output to RS232/ USB</i>	-	Outputs all stored measurement data to the interface.
<i>Data storage / Manual data storage / Erase</i>	-	Erases the entire manual measurement data memory. Note: All calibration data remain stored when this action is performed.

**Display presentation
of a dataset**

Manual data storage		3 of ◀▶
15.03.2016 11:24:16	<i>ID number: 1</i>	
SenTix 940	B2023400856	5
pH 7.000 24.8 °C AR Sensor: +++		
30.09.2015 08:00		

Sample printout

15.03.2016 09:56:20 Multi 3620 IDS Ser. no. 09250023
SenTix 940 Ser. no. B092500013 <i>ID number 2</i> pH 6.012 24.8 °C, AR, Sensor: +++
15.03.2016 10:56:20 Multi 3620 IDS Ser. no. 09250013
SenTix 940 Ser. no. B092500013 <i>ID number 2</i> pH 6.012 24.8 °C, AR, Sensor: +++
etc...

Quitting the display

To quit the display of stored measurement datasets, you have the following options:

- Switch directly to the measured value display with **<M>**.
- Quit the display and move to the next higher menu level with **<ESC>**.

11.3.2 Erasing the measurement data memory

How to erase the measurement data memory is described in section 11.3.1 EDITING THE MEASUREMENT DATA MEMORY.

11.3.3 Measurement dataset

A complete dataset consists of:

- Date/time
- Meter name, series number
- Sensor name, series number

- *ID number*
- Measured value of the connected sensor
- Measured temperature value of the connected sensor
- AutoRead info: *AR* appears with the measured value if the AutoRead criterion was met while storing (stable measured value). Otherwise, the *AR* display is missing.
- Calibration evaluation:
 - 4 levels (+++, ++, +, -, or no evaluation) or
 - QSC (percentage)

Memory locations

The Multi 3620 IDS meter has two measurement data memories. The measured values recorded either manually or automatic are stored separately in individual measurement data memories.

Data memory	Maximum number of datasets
<i>Manual data storage</i>	500
<i>Automatic data storage</i>	10000

12 Transmitting data

The meter has the following interfaces:

- USB-B interface (*USB Device*)
e.g. to connect a PC
- USB-A interface (*USB Host*),
e.g. to connect a USB flash drive/USB printer

Via the USB-B interface (*USB Device*) you can transmit data to a PC or printer and update the meter software.

Via the USB-A interface (*USB Host*) it is possible to transfer data to an external USB memory device/USB printer.

12.1 Saving data to a USB memory device

Via the USB-A interface (*USB Host*) you can transmit data to a USB memory device or USB printer. How to transmit data to a USB printer is described in an extra section (see section 12.2).

Connecting the USB memory device

1. Connect a USB memory device to the USB-A interface (*USB Host*).

Transmitting data (options)

Data	Control	Operation / description
Stored measured values	Manual	All datasets with the function, <i>Output to USB flash drive or printer</i> (menu <i>Data storage / Manual data storage</i> or <i>Automatic data storage</i>). For details, see section 11.3.1
Calibration data storage	Manual	All stored calibration records of a sensor with the function, <i>Output to USB flash drive or printer</i> (menu <i>Calibration / Calibration data storage</i>). For details, see menu for calibration and measurement settings of the sensor.

12.2 Transmitting data to a USB printer

Via the USB-A interface (*USB Host*) you can transmit data to a USB printer or USB memory device. How to transmit data to a USB memory device is described in an extra section (see section 12.1).

Connecting a USB printer

Suitable USB printers

Model	Type	Paper width
Citizen CT-S281	Thermal transfer printer	58 mm
Seiko Instruments Inc. DPU-S445*	Thermal transfer printer	58 mm
Star SP700 with USB interface**	Matrix printer	76 mm

* Recommended printer settings for DPU-S445:

- Character Set : IBM Compatible

** Recommended printer settings for Star SP700:

- CodePage 437

- DIP switch 1...7: =ON, DIP switch 8: OFF

Details: see operating manual of your printer.

1. Connect the USB printer to the *USB Host* interface.
2. Connect the power pack to the Multi 3620 IDS (see section 3.3.2). As soon as the USB printer is identified by the meter, the printer status indicator [] is displayed.

Transmitting data (options)

The following table shows which data are transmitted to the interface in which way:

Data	Control	Operation / description
Current measured values of all connected sensors	Manual	<ul style="list-style-type: none"> ● With <PRT>. ● Simultaneously with every manual storing process (see section 11.1).
	Automatic, at intervals	<ul style="list-style-type: none"> ● With <PRT_>. Then you can set the transmission interval ● Simultaneously with every automatic storing process (see section 11.2).
Stored measured values	Manual	<ul style="list-style-type: none"> ● Displayed dataset with <PRT> after calling up from the storage. ● All datasets with the function, <i>Output to USB flash drive or printer</i> (menu <i>Data storage / Manual data storage</i> or <i>Automatic data storage</i>). <p>For details, see section 11.3.1.</p>

Data	Control	Operation / description
Calibration records	Manual	<ul style="list-style-type: none"> ● Displayed calibration record with <PRT>. ● All stored calibration records of a sensor with the function, <i>Output to USB flash drive or printer</i> (menu <i>Calibration / Calibration data storage</i>). <p>For details, see menu for calibration and measurement settings of the sensor.</p>
	Automatic	<ul style="list-style-type: none"> ● At the end of a calibration procedure



The following rule applies: With the exception of the menus, shortly pressing the **<PRT>** key generally outputs the display contents to the interface (displayed measured values, measuring datasets, calibration records). If there is a USB-B connection (*USB Device*), e.g. to a PC, the data are output to the USB-B interface only (*USB Device*).

12.3 Transmitting data to a PC

Via the USB-B interface (*USB Device*) you can transmit data to a PC.

PC system requirements

- Microsoft Windows (for details, see enclosed installation CD, *Driver* directory)
- Installed USB driver for the meter (see CD-ROM or Internet)
- Settings for the USB/RS232 interface on the PC and meter in agreement
- Program to receive the measurement data on the PC (e.g. MultiLab Importer, see CD-ROM or Internet)

Installation of the USB driver

1. Insert the supplied installation CD in the CD drive of your PC.
or
Download the USB driver from the Internet.
2. Install the driver.
Follow the Windows installation instructions as necessary.

Connecting a PC

1. Connect the Multi 3620 IDS to the PC via the USB-B interface (*USB Device*).
The meter is listed as a virtual COM interface among the connections in the Windows instrument manager.

Adjusting the settings for the data transmission

2. Set the same transmission data at the meter and PC:
 - Baud rate: to be selected in the range 1200 ... 19200
 - Set at the PC only:
 - Handshake: RTS/CTS
 - Parity: none
 - Data bits: 8
 - Stop bits: 1

Starting the program for the data reception

3. On the PC, start the program for the data reception, e.g.:
 - MultiLab Importer (see section 12.4)
 - Terminal program

Transmitting data (options)

Data	Control	Operation / description
Current measured values of all connected sensors	Manual	<ul style="list-style-type: none"> ● With <PRT>. ● Simultaneously with every manual storing process (see section 11.1).
	Automatic, at intervals	<ul style="list-style-type: none"> ● With <PRT_>. Then you can set the transmission interval ● Simultaneously with every automatic storing process (see section 11.2).
Stored measured values	Manual	<ul style="list-style-type: none"> ● Displayed dataset with <PRT> after calling up from the storage. ● All datasets with the function, <i>Output to RS232/USB</i> (menu <i>Data storage / Manual data storage</i> or <i>Automatic data storage</i>). For details, see section 11.3.1.
Calibration records	Manual	<ul style="list-style-type: none"> ● Displayed calibration record with <PRT> ● All calibration records with <i>Output to RS232/USB</i> (menu <i>Calibration / Calibration data storage</i>)
	Automatic	<ul style="list-style-type: none"> ● At the end of a calibration procedure



The following rule applies: With the exception of the menus, shortly pressing the <PRT> key generally outputs the display contents to the interface (displayed measured values, measuring datasets, calibration records). If there is a USB-B connection (*USB Device*), e.g. to a PC, the data are output to the USB-B interface only (*USB Device*).

12.4 MultiLab Importer

With the aid of the MultiLab Importer software, you can record and evaluate measurement data with a PC.



More detailed information can be found in the MultiLab Importer operating manual.

13 Maintenance, cleaning, disposal

13.1 Maintenance

13.1.1 General maintenance activities

The only maintenance activity required is replacing the batteries.



See the relevant operating manuals of the IDS sensors for instructions on maintenance.

13.1.2 Replacing the rechargeable batteries

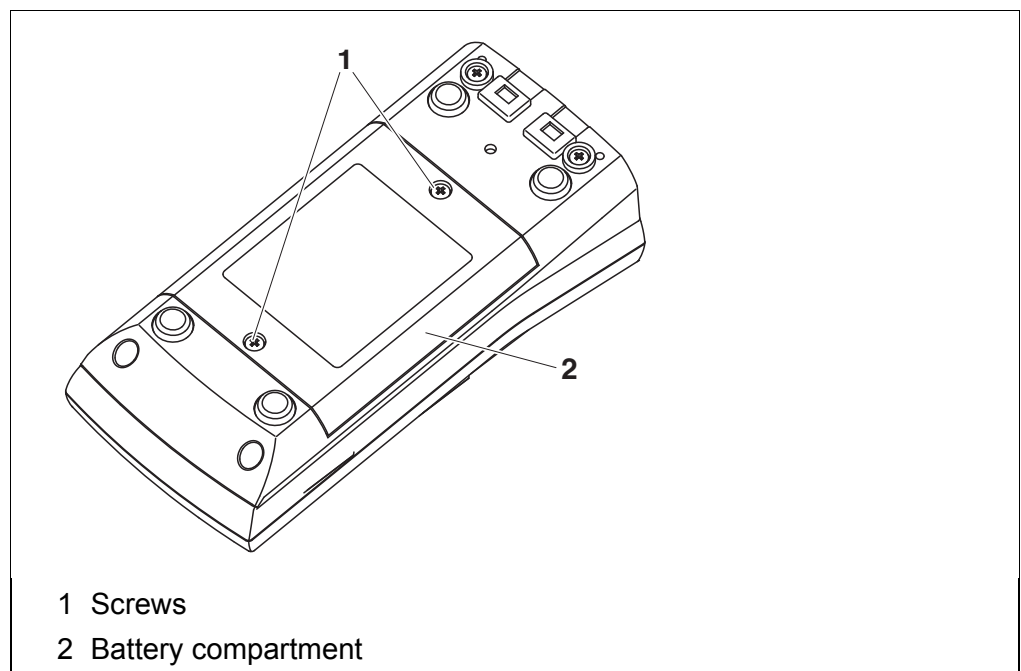

- 1 Unscrew the two screws (1) on the underside of the meter.
- 2 Open the battery compartment (2) on the underside of the meter.
- 3 Remove the four rechargeable batteries from the battery compartment.



CAUTION

Make sure that the poles of the rechargeable batteries are positioned correctly. The \pm signs on the batteries must correspond to the \pm signs in the battery compartment.

- 4 Place four new rechargeable batteries (type Mignon AA) in the battery compartment.

- 5 Close the battery compartment (2) and tighten the screws (1).
- 6 Charge the batteries completely prior to putting the meter into operation for the first time.
The charging process takes approx. 24 hours.



Dispose of used batteries according to the local regulations of your country.

End users within the European Union are obligated to return used batteries (even ecologically compatible ones) to a collection point set up for recycling purposes.

Batteries are marked with the crossed-out waste container symbol. Therefore, they may not be disposed with the domestic waste.

13.2 Cleaning

Occasionally wipe the outside of the measuring instrument with a damp, lint-free cloth. Disinfect the housing with isopropanol as required.



CAUTION

The housing is made of synthetic material (ABS). Thus, avoid contact with acetone or similar detergents that contain solvents. Remove any splashes immediately.

13.3 Packing

This meter is sent out in a protective transport packing.
We recommend: Keep the packing material. The original packing protects the meter against damage during transport.

13.4 Disposal



Within the European Union, the batteries are removed at a specialized treatment center at the instrument's end of life. The instruments are taken to one of those specialized treatment centers via the recycling system set up for this purpose.

14 What to do if...

14.1 General information

Sensor symbol flashes	Cause – Calibration interval expired	Remedy – Recalibrate the measuring system
Display 	Cause – Batteries almost empty	Remedy – Charge the batteries (see section 3.3.2 CONNECTING THE POWER PACK / CHARGING THE BATTERIES) – Replace the batteries (see section 13.1 MAINTENANCE)
Meter does not react to keystroke	Cause – Operating condition undefined or EMC load unallowed	Remedy – Processor reset: Press the <ENTER> and <On/Off> key simultaneously
You want to know which software version is in the meter or IDS sensor	Cause – E.g., a question by the service department	Remedy – Switch on the meter. – Open the menu, <ENTER__> / <i>Storage & config / System / Service information</i> . The instrument data are displayed. or – Connect the sensor. Press softkey [<i>Info</i>]/[<i>More</i>] The sensor data are displayed (see section 4.1.6)
Data transmission to USB memory device does not work	Cause – Connected USB memory device was not recognized – The USB memory device has been formatted to a file system which is not supported, e. g. NTFS	Remedy – Use other USB memory device – Reformat the USB memory device to FAT 16 or FAT 32 file system (Caution: Reformatting erases all data on the USB memory device. Back up all data before reformatting.)

Data transmission to USB printer does not work

Cause	Remedy
– The USB-B interface is connected to a PC	– Disconnect the PC from the USB-B interface
– Connected USB printer does not print	– Use a suitable USB printer (see section 12.2) – Check the printer settings (see section 12.2)
– No power pack connected	– Connect the power pack

Error message, Only use rechargeable batteries! Ni-MH 1.2 V, >2000 mAh

Cause	Remedy
– A battery voltage untypical for NiMH batteries was identified.	– Disconnect the power pack from the meter. – Check whether the batteries in the battery compartment are suitable (<i>Ni-MH 1.2 V, >2000 mAh</i>). – Unsuitable batteries: Insert suitable batteries and reconnect the power pack. – Suitable batteries: Connect the power pack and close the error message with <[ESC]> or <M>.

**CAUTION**

The charging of unsuitable battery types may cause damage.

Error message, Memory error 1

Cause	Remedy
– Instrument storage was not found	– <i>Please contact the service.</i>

14.2 pH**Error message OFL, UFL**

Cause	Remedy
IDS-pH sensor:	
– Measured value outside the measuring range	– Use suitable IDS-pH sensor
– Air bubble in front of the junction	– Remove air bubble

	Cause	Remedy
	– Air in the junction	– Extract air or moisten junction
	– Gel electrolyte dried out	– Exchange IDS-pH sensor
Error message, Error	Cause	Remedy
	IDS-pH sensor:	
	– The values determined for zero point and slope of the IDS-pH sensor are outside the allowed limits.	– Recalibrate
	– Junction contaminated	– Clean the junction
	– IDS-pH sensor broken	– Exchange IDS-pH sensor
	Buffer solutions:	
	– The used buffer solutions do not agree with the set buffer set	– Set different buffer set or – Use different buffer solutions
	– Buffer solutions too old	– Use only once. Note the shelf life
– Buffer solutions depleted	– Change solutions	
No stable measured value	Cause	Remedy
	IDS-pH sensor:	
	– Junction contaminated	– Clean the junction
	– Membrane contaminated	– Clean membrane
	Test sample:	
	– pH value not stable	– Measure with air excluded if necessary
	– Temperature not stable	– Adjust temperature if necessary
	IDS-pH sensor + test sample:	
	– Conductivity too low	– Use suitable IDS-pH sensor
	– Temperature too high	– Use suitable IDS-pH sensor
– Organic liquids	– Use suitable IDS-pH sensor	

Obviously incorrect measured values	Cause	Remedy
	IDS-pH sensor:	
	– IDS-pH sensor unsuitable	– Use suitable IDS sensor
	– Temperature difference between buffer and test sample too great	– Adjust temperature of buffer or sample solutions
	– Measurement procedure not suitable	– Follow special procedure

14.3 Dissolved oxygen

Error message, OFL	Cause	Remedy
	– Measured value outside the measuring range	– Select a suitable measuring medium

Error message, Error	Cause	Remedy
	– Sensor contaminated	– Clean the sensor
	– Measured temperature value outside the operating conditions (display of OFL/UFL instead of a temperature value)	– Keep to the temperature range for the test sample
	– Defective sensor	– Replace the sensor



More information and instructions on cleaning and exchange of sensors are given in the documentation of your sensor.

14.4 Conductivity

Error message, OFL	Cause	Remedy
	– Measured value outside the measuring range	– Use suitable IDS conductivity sensor

Error message, Error	Cause	Remedy
	– Sensor contaminated	– Clean the sensor and replace it if necessary
	– Calibration solution not suitable	– Check the calibration solutions



More information and instructions on cleaning and exchange of sensors are given in the documentation of your sensor.

14.5 Turbidity

Implausible turbidity values	Cause	Remedy
	– There are gas bubbles (e.g. air bubbles) in front of the measurement window	– Remove the gas bubbles, e.g. by immersing the sensor at an angle
	– Incorrect calibration, e.g.: <ul style="list-style-type: none"> – Unsuitable calibration standard solutions (e.g. too old) – Unsuitable calibration environment (e.g. gas bubbles, reflection, light) 	– Check the calibration
	– Minimum depth of immersion not observed	– Heed the minimum depth of immersion of the sensor (2 cm)
Error message, OFL	Cause	Remedy
	– Measured value outside the measuring range	– Select a suitable measuring medium
Measured values too low	Cause	Remedy
	– Measurement window soiled	– Clean the measurement window
Measured values too high	Cause	Remedy
	– Reflection at the walls or bottom of the measuring vessel	– Keep the minimum distance of the sensor towards the walls and bottom of the measuring vessel (see section 14.5)
	– Incidence of light	– Use a light-proof measuring vessel



More information and instructions on cleaning and exchange of sensors are given in the documentation of your sensor.

15 Technical data

15.1 General data

Dimensions	Approx. 180 x 80 x 55 mm	
Weight	Approx. 0.4 kg	
Mechanical structure	Type of protection	IP 67
Electrical safety	Protective class	III
Test certificates	CE	
Ambient conditions	Storage	- 25 °C ... + 65 °C
	Operation	-10 °C ... + 55 °C with the power pack connected (battery charging): 0 °C ... + 40 °C
	Admissible relative humidity	Yearly mean: < 75 % 30 days/year: 95 % Other days: 85 %
Power supply	Rechargeable batteries	4 x 1.2 V NiMH batteries, type AA
	Operational life	Approx. 150 h [#]
	Power pack (charging device)	Kuantech Co. Ltd. KSAC 0900110W1UV-1 Input: 100 ... 240 V ~ / 50 ... 60 Hz / 270 mA Output: 9 V = / 1.1 A Connection max. overvoltage category II Primary plugs contained in the scope of delivery: Euro, US, UK and Australian.
USB interface (device)	Type	USB 1.1 USB-B (Device), PC
	Baud rate	Adjustable: 1200, 2400, 4800, 9600, 19200 Baud
	Data bits	8
	Stop bits	2
	Parity	None
	Handshake	RTS/CTS
	Cable length	Max. 3 m

- [#] The operational life is shorter if, e.g.
- several sensors are operated
 - the maximum display illumination is set

USB interface (host)	Type	USB 2.0 USB-A (host), USB device
Guidelines and norms used	EMC	EC directive 2004/108/EC EN 61326-1 EN 61000-3-2 EN 61000-3-3 FCC Class A
	Meter safety	EC directive 2006/95/EC EN 61010-1
	IP protection class	EN 60529

15.2 Measuring ranges, resolution, accuracy

Measuring ranges, accuracy	Variable	Measuring range	Accuracy
	Air pressure (absolute)*	300 ... 1100 mbar	± 4 mbar

* Available only if a D.O. sensor is connected



Further data are given in the documentation of your sensor.

16 Appendix: Firmware update

16.1 Firmware update for the meter Multi 3620 IDS

You can find available firmware update files for your meter on the Internet. With the "Firmware Update " program and a PC you can update the firmware of the Multi 3620 IDS to the newest version.

For the update you have to connect the meter to a PC via the USB interface.

The update requires:

- a free USB interface (virtual COM port) on the PC
- the driver for the USB interface (on the enclosed CD-ROM)
- the USB cable (included in the scope of delivery of the Multi 3620 IDS).

- 1 Install the downloaded firmware update on a PC.

An update folder is created in the Windows start menu.

If an update folder already exists for the meter (or meter type), the new data are displayed there.

- 2 In the windows start menu, open the update folder and start the firmware update program for the meter
- 3 Using the USB interface cable, connect the Multi 3620 IDS to a USB interface (virtual COM port) of the PC.
- 4 Switch on the Multi 3620 IDS.
- 5 In the firmware update program, start the update process with OK.
- 6 Follow the instructions of the firmware update program.
During the programming process, a corresponding message and a progress bar (in %) are displayed.
The programming process takes up to 15 minutes. A terminatory message is displayed after a successful programming process. The firmware update is completed.
- 7 Disconnect the Multi 3620 IDS from the PC.
The Multi 3620 IDS is ready for operation again.

After switching the meter off and on you can check whether the meter has taken over the new software version (see page 98).

16.2 Firmware-Update for IDS Sensors

You can find available firmware update files for your IDS sensor on the Internet. With the "Firmware Update" program and a PC you can update the firmware of an IDS sensor to the newest version.

For updating, connect the IDS sensor to the Multi 3620 IDS with a cable, and the Multi 3620 IDS to a PC via the USB-B interface.

The update requires:

- a free USB interface (virtual COM port) on the PC
- the driver for the USB interface (on the enclosed CD-ROM)
- the USB cable (included in the scope of delivery of the Multi 3620 IDS).

- 1 Install the downloaded firmware update on a PC.

An update folder is created in the Windows start menu.

If an update folder already exists for the sensor (or sensor type), the new data are displayed there.

- 2 In the windows start menu, open the update folder and start the firmware update program for the IDS sensor
- 3 Connect the IDS sensor to the meter.
Only the sensor connection in the lower section of the socket field (channel 1) is suitable for firmware update.
- 4 Using the USB interface cable, connect the Multi 3620 IDS to a USB interface (virtual COM port) of the PC.
- 5 Switch on the Multi 3620 IDS.
- 6 In the firmware update program, start the update process with OK.
- 7 Follow the instructions of the firmware update program.
During the programming process, a corresponding message and a progress bar (in %) are displayed.
The programming process takes up to 5 minutes. A terminatory message is displayed after a successful programming process. The firmware update is completed.
- 8 Disconnect the Multi 3620 IDS from the PC.
Meter and sensor are ready for operation again.

After switching the meter off and on you can check whether the sensor has taken over the new software version (see page 98).

17 Glossary

Adjusting	To manipulate a measuring system so that the relevant value (e.g. the displayed value) differs as little as possible from the correct value or a value that is regarded as correct, or that the difference remains within the tolerance.
Asymmetry	see zero point
AutoRange	Name of the automatic selection of the measuring range.
Calibration	Comparing the value from a measuring system (e.g. the displayed value) to the correct value or a value that is regarded as correct. Often, this expression is also used when the measuring system is adjusted at the same time (see adjusting).
D.O. saturation	Short name for the "relative D.O. saturation".
D.O. partial pressure	Pressure caused by the oxygen in a gas mixture or liquid.
Electromotive force of an electrode	The electromotive force U of the combination electrode is the measurable electromotive force of an electrode in a solution. It equals the sum of all the galvanic voltages of the combination electrode. Its dependency on the pH results in the electrode function, which is characterized by the parameters, slope and zero point.
Junction	The junction is a porous body in the housing wall of reference electrodes or electrolyte bridges. It arranges the electrical contact between two solutions and makes the electrolyte exchange more difficult. The expression, junction, is also used for ground or junction-less transitions.
Measured parameter	The measured parameter is the physical dimension determined by measuring, e.g. pH, conductivity or D.O. concentration.
Measured value	The measured value is the special value of a measured parameter to be determined. It is given as a combination of the numerical value and unit (e. g. 3 m; 0.5 s; 5.2 A; 373.15 K).
ORP	The ORP is caused by oxidizing or reducing substances dissolved in water if these substances become effective on an electrode surface (e.g. a gold or platinum surface).
pH value	The pH value is a measure of the acidic or basic effect of an aqueous solution. It corresponds to the negative decadic logarithm of the molal hydrogen ions activity divided by the unit of the molality. The practical pH value is the value of a pH measurement.
Potentiometry	Name of a measuring technique. The signal (depending on the measured parameter) of the electrode is the electrical potential. The electrical current remains constant.
Reset	Restoring the original condition of all settings of a measuring system.
Resolution	Smallest difference between two measured values that can be displayed by a meter.

Salinity	The absolute salinity S_A of seawater corresponds to the relationship of the mass of dissolved salts to the mass of the solution (in g/Kg). In practice, this dimension cannot be measured directly. Therefore, the practical salinity according to IOT is used for oceanographic monitoring. It is determined by measuring the electrical conductivity.
Salt content	General designation for the quantity of salt dissolved in water.
Slope	The slope of a linear calibration function.
Stability control (AutoRead)	Function to control the measured value stability.
Standard solution	The standard solution is a solution where the measured value is known. It is used to calibrate a measuring system.
Test sample	Designation of the test sample ready to be measured. Normally, a test sample is made by processing the original sample. The test sample and original sample are identical if the test sample was not processed.
Zero point	The zero point of a pH combination electrode is the pH value at which the electromotive force of the pH combination electrode at a specified temperature is zero. Normally, this is at 25 °C.

18 Index

A

Automatic switch-off function	81
AutoRead	49, 57, 64
ORP	45
pH	29

B

Battery compartment	13, 96
---------------------	--------

C

Calibration	
Conductivity	59
pH	31, 47
Calibration evaluation	
Conductivity	61
ISE	69
O ₂	54
pH	39
Calibration interval	
Conductivity	77, 79
O ₂	75
pH	73
Calibration points	
pH	38
Calibration records	38, 54, 60
Cell constant	59
Connect the power pack	13
Connecting a PC	91, 93
Connectors	18
Copyright	2

D

Dataset	89
Date and time	27
Default settings	
Measured parameter	82
System settings	84
Display	17

E

Energy saving feature	14
-----------------------	----

F

FDO® Check	50
Firmware update	105

I

Initial commissioning	12, 14
Initialize	81
Interval for calibration	73

K

Keys	16
------	----

M

Measured value display	24
Measurement accuracy	74
Measurement data memory	
Edit	88
Erase	88
Measurement dataset	89
Measuring	
Conductivity	56, 63
O ₂	48
ORP	45
pH	29
Menus (navigation)	24
Messages	25

P

pH buffer sets	71
----------------	----

R

Reset	81
-------	----

S

Scope of delivery	12
Setting the date	15
Setting the time	15
Single-point calibration	
pH	33, 36
Slope	
pH	31
Slope, relative	52
Stability control	
Automatic	81
Manual	29, 45, 49
Storing in memory	85
Automatic	86
Manual	85
Storing interval	85

T

Temperature compensation	58
Temperature measurement	
Conductivity	58
O2	50
pH	30, 46
Three-point calibration	
ISE	68
pH	33, 37
Transmitting data	91
Transmitting measured values	91
Two-point calibration	
ISE	67
pH	33, 36

Z

Zero point of pH electrode	31
----------------------------------	----

What can Xylem do for you?

We're a global team unified in a common purpose: creating innovative solutions to meet our world's water needs. Developing new technologies that will improve the way water is used, conserved, and re-used in the future is central to our work. We move, treat, analyze, and return water to the environment, and we help people use water efficiently, in their homes, buildings, factories and farms. In more than 150 countries, we have strong, long-standing relationships with customers who know us for our powerful combination of leading product brands and applications expertise, backed by a legacy of innovation.

For more information on how Xylem can help you, go to xylem.com.



Service address:

Xylem Analytics Germany
Sales GmbH & Co. KG
WTW
Dr.-Karl-Slevogt-Str. 1
82362 Weilheim
Germany

Tel.: +49 881 183-325
Fax: +49 881 183-414
E-Mail wtw.rma@xylem.com
Internet: www.WTW.com



Xylem Analytics Germany GmbH
Dr.-Karl-Slevogt-Str. 1
82362 Weilheim
Germany