

Turb 430 IR/T

TASCHENTURBIDIMETER



a xylem brand

**Hinweise zu dieser
Bedienungs-
anleitung**

Diese Bedienungsanleitung enthält in kompakter Form

- die Beschreibung aller Grundfunktionen,
- alle Hinweise für den sicheren Betrieb und
- alle technischen Daten.

Eine ausführlichere Beschreibung mit Hinweisen für besondere Anwendungen erhalten Sie als pdf-Dokument auf der beiliegenden CD-ROM und im Internet unter <http://www.WTW.com>.

Turb 430 IR/T - Contents

Safety	4
Display and socket field	4
Power supply	5
General operating principles	5
Initial commissioning	8
Operation	8
Inserting a cell	8
Maintenance, cleaning	11
What to do if...	13
General errors	13
Turbidity	13
Technical data	14
General data	14
Turbidity (Turb 430 IR)	16
Turbidity (Turb 430 T)	16



Note

Part of the process of consequently improving our products is the continuous further development of instrument firmware. All current data for the Turb 430 IR/T can be found on the Internet under <http://www.WTW.com>:

- Firmware
- Operating manual

You can easily transfer new firmware to your instrument with the aid of the AK 540/B cable and a PC. More detailed information can be found in the appendix of the detailed operating manual on the CD-ROM provided.

Safety

Target group

The meter was developed for work in the field and in the laboratory. Thus, we assume that, as a result of their professional training and experience, the operators will know the necessary safety precautions to take when handling chemicals.

The personnel responsible for the commissioning, operation and maintenance must have the necessary qualifications for this work. If the personnel do not have the required skills they have to be instructed. Furthermore, it must be ensured that the personnel read and completely understand the present operating manual.

Safety instructions

Safety instructions point out dangers:



Caution

indicates instructions that must be followed precisely in order to avoid the possibility of slight injuries or damage to the instrument or the environment.

Safe operation



Caution

Danger of eye damage by visible and invisible LED radiation. In the cell shaft of the Turb 430 IR there are light emitting diodes (LED) of the 1M class. Do not look at the radiation using optical instruments. With normal, authorized use there is no hazard.

Display and socket field

Display

The graphic display shows all information of the current measurement in the measured value display. The illumination enables to read the display even in the darkness.

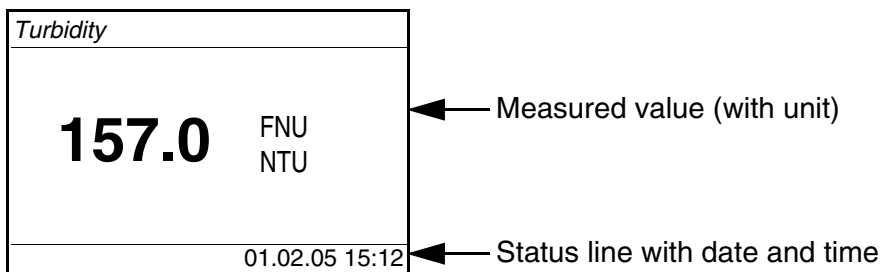

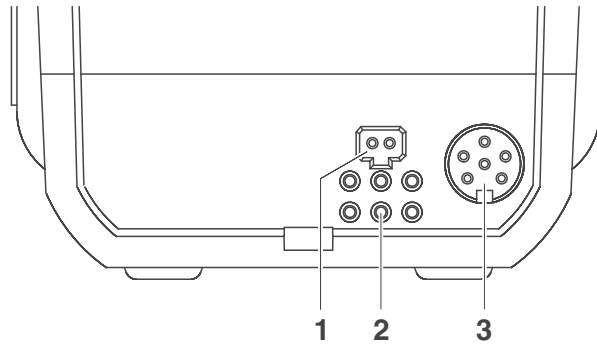
Socket field**Identifying the connectors**

1	Power pack
2	Contacts for operation on the LabStation
3	RS232 serial interface

Power supply

You can operate the meter either with batteries, accumulator pack or a power pack.

The *LoBat* display indicator appears when the batteries or accumulator pack is nearly discharged.









General operating principles

This section contains basic information on the operation of the Turb 430 IR/T.

Operating modes

- Measurement
The display indicates measurement data in the measured value display
- Calibration
The display indicates a calibration procedure with calibration information
- Data transmission
The meter transmits measuring datasets or calibration records to the serial interface
- Configuration
The display indicates a menu with further menus, settings and functions

Keypad

	Switch to the measured value display <M>
	Start calibration <CAL/ZERO>
	Open menus / confirm entries / start measurement <START/ENTER>
	Call up the <i>Configuration</i> menu (all settings are made here) <MENU>
	Switch the meter on/off <ON/OFF>
	Output display contents to RS232 interface (e.g. print) <PRT>
	Open the <i>Store</i> menu: <STO> Quick storing: 2 x <STO>
	Highlight menu items or selection; Set values <▲>, <▼>
	Switch to the next higher menu level / cancel input <ESC>

**Note**

Keys with an additional number printed on are assigned doubly. This enables to directly enter numbers in special menus. Thus, you can, for example, conveniently enter the date and time via the number keys.

Measured value display

In the measured value display, open the menu with <MENU>.

Menus and dialogs

The menus for settings and dialogs in procedures contain further submenus. The selection is made with the <▲> <▼> keys. The current selection is displayed in reverse video.

- Menus

The name of the menu is displayed at the upper edge of the frame.

Menus are opened by confirming with **<START/ENTER>**. Example:

Configuration	
Turbidity	
System	
Info	

- **Settings**

Settings are indicated by a colon. The current setting is displayed on the right-hand side. With **<START/ENTER>**, the selection of the possible settings is opened. Subsequently, the setting can be changed with **<▲>** **<▼>** and **<START/ENTER>**.

Example:

System	
Language:	Deutsch
Beep:	Off
Illumination:	On
Contrast:	48 %
Temperature unit:	°C
Switchoff time:	30 min

- **Functions**

Functions are designated by the name of the function. They are immediately carried out by confirming with **<START/ENTER>**.

Example: display the *Calibration record* function (in the *Turbidity* menu).

Turbidity	
Calibration record	
Calibration interval:	090 d
Reset	
■ 2.00 4.01 7.00 10.01	

- **Messages**

Information or operating instructions are designated by the ■ symbol. They cannot be selected.

Example:

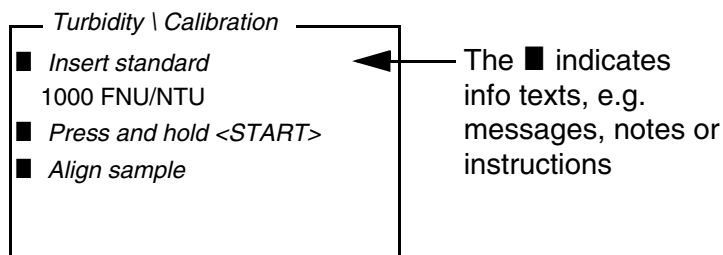

Initial commissioning

Switching on the meter

Press the <ON/OFF> key.

Setting the language

The English language is set on delivery. Set a different language as follows:

1	Open the <i>Configuration</i> menu with the <MENU> key.
2	Open the <i>Configuration / System / Language</i> menu with the <▲> <▼> and <START/ENTER> keys.
3	Select the required language with the <▲> <▼> keys and confirm with <START/ENTER>.
4	Quit the menu with the <M> key.

Setting the date and time

The date and time are set in the menu, *Configuration / System / Continue ... / Date/time*.

Operation

Inserting a cell

To be able to insert cells in the Turb 430 IR/T, the cell shaft has to be prepared to take in a cell.

1	Push the dust cover (1) upward. The cell shaft for 28 mm cells is open.
---	--

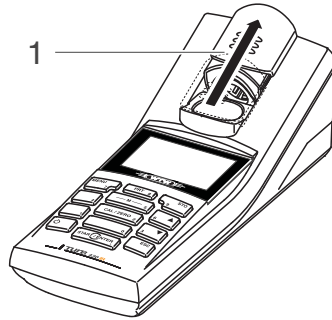

Inserting a 28 mm cell

- | | |
|---|---|
| 2 | <p>Insert the cell so that it is positioned on the bottom of the cell shaft.</p> <p>The cell is ready to be measured.</p> |
|---|---|



- | | |
|---|------------------------------------|
| 3 | <p>Align the cell (see below).</p> |
|---|------------------------------------|

Aligning the cell

- | | |
|---|---|
| 1 | <p>Clean the cell.</p> |
| 2 | <p>Insert the cell.</p> |
| 3 | <p>Align the cell:</p> <ul style="list-style-type: none"> ● Press and hold the <START/ENTER> key. ● Slowly and in small steps rotate the cell by one complete rotation (by 360 °).
After each step wait for a short time until the displayed measured value is stable. ● Turn the cell back to the position with the lowest measured value. |
| 4 | <p>Release the <START/ENTER> key.
Measurement starts. The measured value is displayed.</p> |

**Note**

To keep the drift as low as possible, the time for aligning the cell while pressing and holding the **<START/ENTER>** key is limited to 30 seconds. After this time, the meter starts measuring automatically.

Marking a cell

To be able to quickly bring a cell into the optimum position, it is helpful to mark the optimum position of the cell once it is determined. This shortens each measurement or calibration procedure with this cell considerably.

The marking can, e. g., be done on a label on the cap of the cell.

Measuring turbidity

The outside of the cell always has to be clean, dry, and free of fingerprints and scratches. Clean the cell before starting to measure. Only hold the cells by the top or by the black light protection cap.

1	Rinse out a clean cell with the sample to be measured: Pour approximately 10 ml sample into the cell. Close the cell and rotate it several times before throwing the sample away.
2	Repeat the rinsing procedure twice more.
3	Fill the cell with the sample to be measured (approx. 15 ml). Close the cell with the black light protection cap.
4	Clean the cell.
5	Insert the cell.
6	Align the cell: <ul style="list-style-type: none"> ● Marked cell <ul style="list-style-type: none"> – Align the marking on the cell cap with the marking on the cell shaft. – Press and for a short time hold the <START/ENTER> key until the measured value is displayed. ● Unmarked cell (see page 9) <ul style="list-style-type: none"> – Press and hold the <START/ENTER> key. – Slowly and in small steps rotate the cell by one complete rotation (by 360 °). After each step wait for a short time until the displayed measure value is stable. – Turn the cell back to the position with the lowest measured value.
7	Release the <START/ENTER> key. Measurement starts. The measured value is displayed.

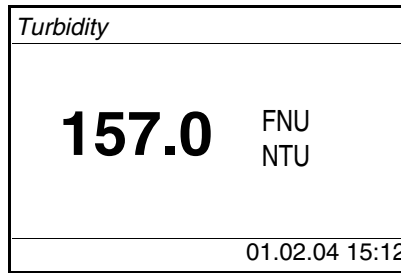

8 Repeat the steps 2 to 8 for further samples.

Calibration

1 Press the <CAL/ZERO> key. The menu-guided calibration begins. Follow the instructions on the display.



Note

Calibrate

- after the calibration interval has expired
- after a temperature change

Maintenance, cleaning

Maintenance

The meter is almost maintenance-free. The only maintenance task is replacing the batteries or accumulator pack.



Caution

Make sure the poles of the batteries are the right way round. The ± signs on the batteries must correspond to the ± signs in the battery compartment.

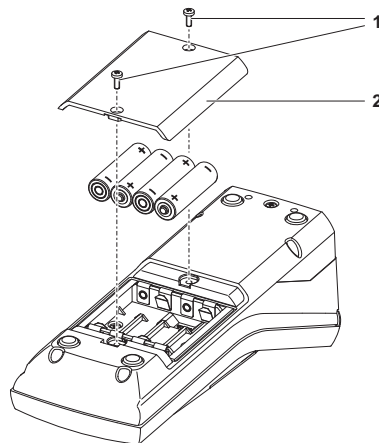

1	Open the battery compartment: – Unscrew the two screws (1) on the underside of the meter, – Remove the lid of the battery compartment (2).
2	If necessary, take four old batteries out of the battery compartment.
3	Insert four batteries (3) in the battery compartment.
4	Close the battery compartment and fix it with the screws.

Cleaning

Occasionally wipe the outside of the meter with a damp, lint-free cloth. Disinfect the housing with isopropanol as required.

**Caution**

The housing components are made out of synthetic materials (polyurethane, ABS and PMMA). Thus, avoid contact with acetone and similar detergents that contain solvents. Remove any splashes immediately.

Cleaning the cell shaft

If liquid is in the cell shaft (e.g. due to a spilled cell), clean the cell shaft as follows:

1	Switch the Turb 430 IR/T off and pull out the power plug.
2	Rinse the cell shaft with distilled water.

Cleaning the cells

Cells have to be clean, dry, and free of fingerprints and scratches. Therefore, clean them regularly:

1	Clean the cells inside and out with hydrochloric acid or laboratory soap.
2	Rinse out several times with distilled water.
3	Let them dry in the air.
4	Only hold the cells by the top or by the light protection cap so that the optical path is not impaired.
5	Before measuring, clean the cell with the enclosed cleaning cloth.

**Note**

Scratches in the glass change the optical characteristics of the cell and falsify the measured value. For this reason, never use scratched cells!

What to do if...

General errors

Display, <i>LoBat</i>	Cause	Remedy
	<ul style="list-style-type: none"> – The batteries or accumulator pack are largely depleted 	<ul style="list-style-type: none"> – Insert new batteries – Charge the accumulator pack
Instrument does not react to keystroke	Cause	Remedy
	<ul style="list-style-type: none"> – Software error – Operating condition undefined or EMC load unallowed 	<ul style="list-style-type: none"> – Processor reset: Press the <START/ENTER> and <PRT> key simultaneously.
Error message, <i>Error 0, 8, 16, 16384</i>	Cause	Remedy
	<ul style="list-style-type: none"> – Instrument error 	<ul style="list-style-type: none"> – Repeat measurement – Meter defective, send meter to WTW for repair and quote the error number

Turbidity

Error message Measured values obviously incorrect	Cause	Remedy
	<ul style="list-style-type: none"> – Cell not correctly inserted 	<ul style="list-style-type: none"> – Lock cell into place
	<ul style="list-style-type: none"> – Cell contaminated 	<ul style="list-style-type: none"> – Clean the cell
	<ul style="list-style-type: none"> – Calibration too old 	<ul style="list-style-type: none"> – Carry out calibration
Measured value display < 0.01 FNU	Cause	Remedy
	<ul style="list-style-type: none"> – Calibration defective – Measured value outside the measuring range 	<ul style="list-style-type: none"> – Carry out calibration – not possible

Technical data

General data

Dimensions	approx. 236 x 86 x 117 mm	
Weight	approx. 0.6 kg (without batteries)	
Mechanical structure	Type of protection	IP 67
Electrical safety	Protective class	III
Test certificates	CE, FCC	
Ambient conditions	Storage	- 25 °C ... + 65 °C
	Operation	0 °C ... + 50 °C
	Climatic class	2
Allowable relative humidity	Yearly mean:	75 %
	30 days /year:	95 %
	other days:	85 %
Power supply	Batteries	4 x 1.5 V, type AA
	Operating time with battery operation	Turb 430 IR: approx. 3000 measurements Turb 430 T: approx. 2000 measurements
	Accumulator pack (optional)	5 x 1.2 V nickel metal hydride (NiMH), type AAA
	Power pack Charging device (optional)	FRIWO FW7555M/09, 15.1432.500-00 Friwo Part. No. 1883259 ----- RiHuiDa RHD20W090150 ----- Input: 100 ... 240 V ~ / 50 ... 60 Hz / 400 mA Output: 9 V = / 1,5 A Connection max. overvoltage category II Primary plugs contained in the scope of delivery: Euro, US, UK and Australian.
	Serial interface	Connection of the cable AK 540/B or AK 540/S
	Baud rate	adjustable: 1200, 2400, 4800, 9600, 19200 Baud
	Type	RS232
	Data bits	8
	Stop bits	2
	Parity	None
	Handshake	RTS/CTS
	Cable length	Max. 15 m

**Guidelines
and norms used**

EMC	EC guideline 89/336/EEC EN 61326-1/A3:2003 FCC Class A
Instrument safety	EC guideline 73/23/EEC EN 61010-1 :2001
Climatic class	VDI/VDE 3540
IP protection	EN 60529:1991

FCC Class A Equipment Statement

Note: This equipment has been tested and found to comply with the limits for a Class A digital device, pursuant to Part 15 of the FCC Rules. These limits are designed to provide reasonable protection against harmful interference when the equipment is operated in a commercial environment. This equipment generates, uses, and can radiate radio frequency energy and, if not installed and used in accordance with the instruction manual, may cause harmful interference to radio communications. Operation of this equipment in a residential area is likely to cause harmful interference in which case the user will be required to correct the interference at his own expense.

Turbidity (Turb 430 IR)

Measuring principle	Nephelometric measurement according to DIN EN ISO 7027	
Light source	Infrared LED	
Measuring range	0.01 ... 1100 FNU/NTU	
Resolution	Range 0.01 ... 9.99	max 0.01 FNU/NTU
	Range 10.0 ... 99.9	max 0.1 FNU/NTU
	Range 100 ... 1100	max 1 FNU/NTU
Accuracy	in the range 0 ... 1100 FNU/NTU	$\pm 2\%$ of the measured value or ± 0.01 FNU/NTU
	Reproducibility	0,5% of the measured value
Response time	4 seconds	
Calibration	Automatic 3-point calibration	

Turbidity (Turb 430 T)

Measuring principle	Nephelometric measurement according to US EPA 180.1	
Light source	White light tungsten lamp	
Measuring range	0.01 ... 1100 NTU	
Resolution	Range 0.01 ... 9.99	max 0.01 NTU
	Range 10.0 ... 99.9	max 0.1 NTU
	Range 100 ... 1100	max 1 NTU
Accuracy	in the range 0 ... 500 NTU	$\pm 2\%$ of the measured value or ± 0.01 NTU
	in the range 500 ... 1100 NTU	$\pm 3\%$ of the measured value
Reproducibility	1% of the measured value	
Response time	7 seconds	
Calibration	Automatic 3-point calibration	

What can Xylem do for you?

We're a global team unified in a common purpose: creating innovative solutions to meet our world's water needs. Developing new technologies that will improve the way water is used, conserved, and re-used in the future is central to our work. We move, treat, analyze, and return water to the environment, and we help people use water efficiently, in their homes, buildings, factories and farms. In more than 150 countries, we have strong, long-standing relationships with customers who know us for our powerful combination of leading product brands and applications expertise, backed by a legacy of innovation.

For more information on how Xylem can help you, go to xylem.com.



Service address:

Xylem Analytics Germany
Sales GmbH & Co. KG
WTW
Dr.-Karl-Slevogt-Str. 1
82362 Weilheim
Germany

Tel.: +49 881 183-325
Fax: +49 881 183-414
E-Mail wtw.rma@xylem.com
Internet: www.WTW.com



Xylem Analytics Germany GmbH
Dr.-Karl-Slevogt-Str. 1
82362 Weilheim
Germany