

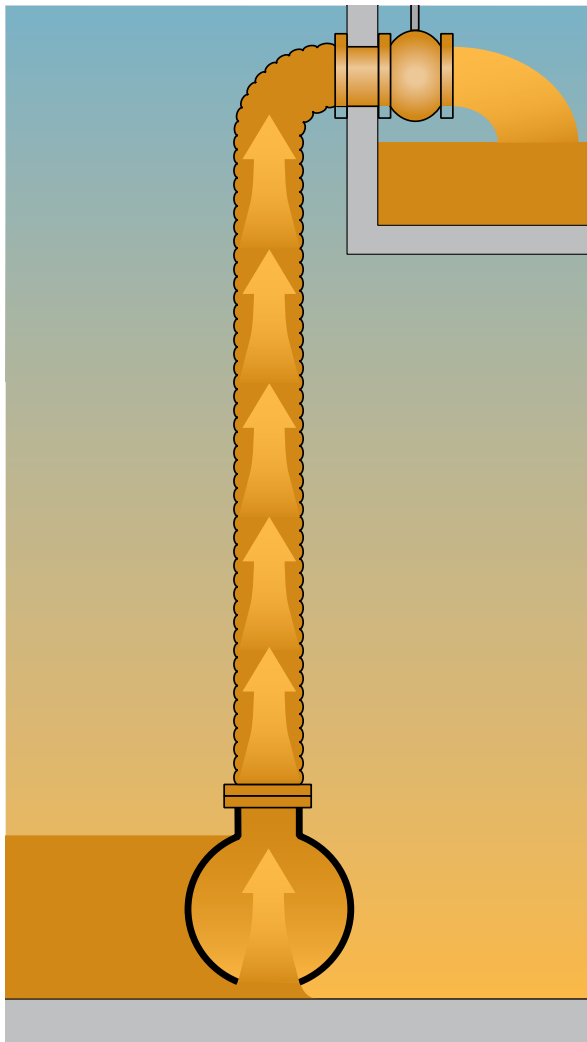

## Leopold® CT2® Submerged Sludge Collector

Superbly Simple, Highly Efficient Sludge Removal  
For Water Treatment Plants



### Reliable, Proven Performance

For more than twenty years Leopold CT2 submerged sludge collector systems have quietly done their job . . . delivering reliable operation, low maintenance costs, and good sludge production in hundreds of facilities worldwide. The CT2 submerged sludge collection system, distinguished by its engineered simplicity, takes sludge removal to the next level. By simplifying the water treatment process, the CT2 sludge collection system increases plant efficiency, and reduces both maintenance time and total system operational costs. It's simply powerful sludge removal you fit and forget.

### Engineered Simplicity

Engineered simplicity is integral to the design of the Leopold CT2 sludge collection system. It operates on a simple principle and a powerful force: gravity. We've designed a superbly simple but highly efficient process to remove sludge by taking advantage of a differential head. Water pressure in the main tank forces the sludge through the header collector into the outlet piping, and away to the sludge removal trough. Careful selection of smooth-bore piping for the suction header keeps head-loss to a minimum for the most efficient sludge removal and low driving head requirements. A simple cable drive moves the suction header across the tank floor at a steady, controlled rate, removing sludge without disturbance. Pumping costs are eliminated and cable drives require far less power.

## Fit and Forget

The Leopold CT2 submerged sludge collection system has a "fit and forget" quality that not only simplifies the water treatment process, but also reduces system operation costs. The header, locked onto the guide rail and controlled by a programmable operating system, goes where and when you want it. The cable drive pulls the header through the sludge with a positive motion

and minimal sludge disturbance, removing the sludge without dilution. This reduces sludge volumes and thickening costs, too. And compared to other submerged sludge collectors, the Leopold CT2 submerged sludge collection system is far simpler to maintain because it has a minimal number of moving parts.

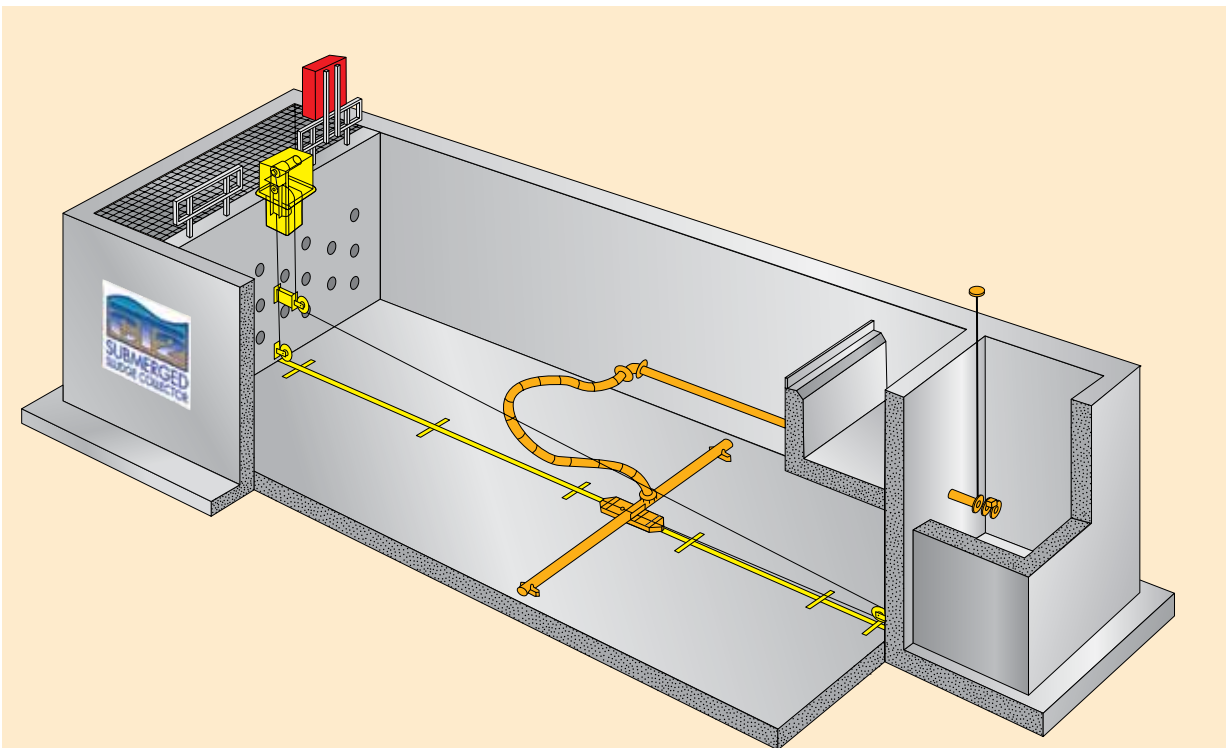

The control system can be tailored to meet individual plant requirements and optimize the performance of the CT2 submerged sludge collection system.



The suction header glides over the surface, removing sludge without causing disturbance, maintaining sludge quality.



A specially designed swivel on the suction header prevents kinking of the hose.



The suction header is locked onto the guide rail with rollers to prevent disruptive derailments.

# Adaptable to a Variety of Plant Requirements

## High-Rate Sedimentation

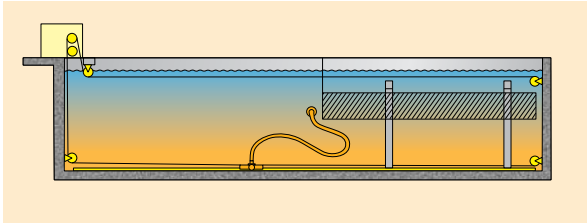

The CT2 sludge collection system can be easily installed or retrofitted into a plate settler or tube settler sedimentation tank. Good quality sludge can then be removed as raw water conditions demand.

## Traditional Sedimentation Tanks

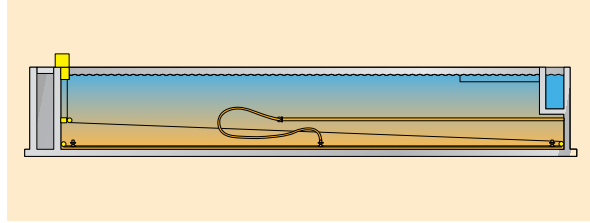

The CT2 sludge collection system is the optimum choice for flat-bottom tanks or tanks with sloped floors. As the suction header glides through the sludge, it removes the settled sludge with minimal dilution and without gross disturbance.

## Multi-Pass Control Options

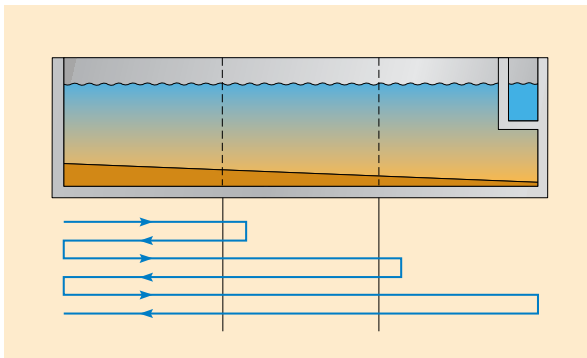

Leopold controls for the CT2 sludge collection system can give each plant the flexibility to meet its individual needs. For example, in sedimentation basins sludge settles unevenly, with more accumulating in the inlet area than in other areas of the basin. Advanced Leopold controls can be programmed to increase sludge removal at the inlet of the tank to even out the sludge load, providing consistent sludge for thickening and disposal.

## Heavy Sludge Production

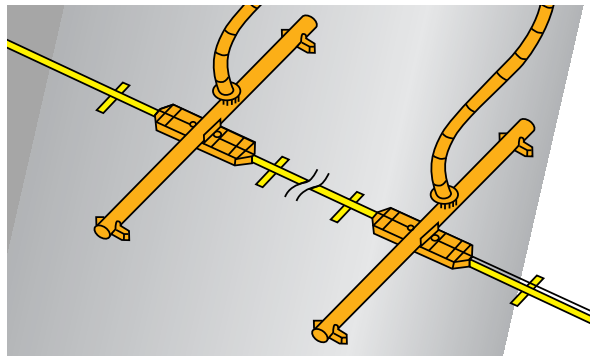

The CT2 sludge collection system can be designed to compensate for high-solids-production water with a double header driven by a single cable system. The travel length of the header is designed to draw the desired amount of sludge from the basin where sludge production is greatest. Double headers also accommodate extra-long basin design.

## Flexible Installation Design

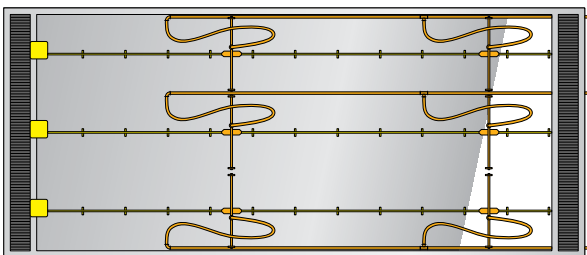

The Leopold CT2 sludge collection system can be designed to accommodate extra-wide sedimentation tanks. And each track can be separately controlled to vary the number of passes and the speed of each pass.

# Xylem ['zīləm]

- 1) The tissue in plants that brings water upward from the roots
- 2) A leading global water technology company

We're 12,000 people unified in a common purpose: creating innovative solutions to meet our world's water needs. Developing new technologies that will improve the way water is used, conserved, and re-used in the future is central to our work. We move, treat, analyze, and return water to the environment, and we help people use water efficiently, in their homes, buildings, factories and farms. In more than 150 countries, we have strong, long-standing relationships with customers who know us for our powerful combination of leading product brands and applications expertise, backed by a legacy of innovation.

For more information on how Xylem can help you, go to [xylem.com](http://xylem.com).



Xylem, Inc.  
227 South Division Street  
Zelienople, PA 16063  
Telephone: (724) 452-6300  
Fax: (724) 452-1377  
[www.xylem.com](http://www.xylem.com)

