



HYPACK
a xylem brand

HYSWEEP® Interfacing Notes 2024

Version 2024.0

56 Bradley St.
Middletown, CT 06457
USA
www.hypack.com

Phone: 1-860-635-1500
Fax: 1-860-635-1522
Tech. Support: help@hypack.com

Table of Contents

Update History:	5
Advanced Navigation INS Network.....	7
Advanced Navigation INS Serial.....	8
AML 3 & 6.....	8
Analog Sidescan	10
Applanix POS MV Network.....	11
Applanix POS/MV Serial.....	14
Atlas Bomasweep	15
Atlas Fansweep (Network), Hydrosweep MD2 (HYPACK 2009A and Earlier).....	16
Atlas Fansweep, Hydrosweep MD2, MD/30, MD/50, DS (HYPACK 2010 and Later).....	17
Atlas Fansweep (Serial).....	20
BlueView BV5000	21
BlueView Multibeam.....	23
Benthos C3D.....	24
Carlson Merlin	25
Coda-Octopus F180.....	26
Coda-Octopus F290.....	27
Edgetech 4600/6205.....	28
FURUNO HS Series Multibeam.....	29
Generic Attitude	30
GeoAcoustics GeoSwath	31
Hydro-Tech Multibeam.....	33
HYPACK Navigation	35
Imagenex AUV.....	37
Imagenex Delta T.....	38
Imagenex Delta T – Dual Head.....	40
Imagenex DT100 SIR.....	41
IS Tech Multibeam	42
IXSEA Octans Network.....	43
IXSEA Octans Serial.....	44
iXBlue IMU (Serial, TCP, UDP).....	45
JAE JM7531 MRU.....	46
Klein HydroChart 3500.....	47
Klein 5000	49
Kongsberg KMALL.....	50
Kongsberg EM3000	51

Kongsberg EM1002, EM2000, EM2040, EM3002/D, EM302, EM710	53
Kongsberg ME70	55
Kongsberg SM2000	56
Kongsberg MS 1000 Profiler	57
KVH Gyrotrac	58
Leica P20/P15/P30/P16, P40, P50	59
MDL Dynascan laser	60
NMEA Gyro	61
NORBIT Dual Head.....	62
NORBIT WBMS	64
Novatel SPAN	66
Odom Echoscans II.....	67
Odom ES3.....	68
Odom ES3 – Dual Head.....	69
Odom MB1	70
Odom MB1 – Dual Head	71
Odom Miniscan	72
Optech ILRIS 3D	73
Optech Polaris.....	76
Ouster OS-1	78
Picotech PicoMBES	80
PingDSP 3DSS-DX.....	81
R2Sonic Dual Head 2020, 2024	82
R2Sonic SONIC 2020, 2024	84
R2Sonic SONIC 2024 (Seabat 81P compatible mode)	86
Renishaw SLM laser	88
RIEGL LMS Series laser	89
RIEGL V Series laser	90
Reson Dual 7125, T20-P, T50-P.....	92
Reson Dual 8101 (NY).....	94
Reson Odom MB2.....	95
Reson Seabat 7101, 7125, 7150, 7160, 8125H, T20-P, T50-P, T51	97
Reson Seabat 8101	99
Reson Seabat 81xx (Network)	100
Reson Seabat 81xx (Serial)	101
Reson Seabat 9001 / 9003	102
Ross Smart Sweep	103

SBG Systems Ekinox.....	104
Seabeam 1000 Series.....	106
Seabeam 2100.....	108
Seabeam 3000 Series.....	109
Seatex MRU6.....	110
SG Brown 1000S Gyro.....	111
SEA SWATHplus and Bathyswath.....	112
Tritech Gemini Profiler	114
Tritech SeaKing.....	115
TSS 335	117
TSS DMS	118
TSS POS/MV	120
Valeport SWiFT SVP & CTD.....	121
Velodyne HDL-32E & VLP-16.....	122
WASSP Multibeam.....	124
Notes:.....	125
Devices in Beta Testing	127
Appendix A: Analog Sidescan Interfacing.....	128
Appendix B: A Short List of Odd Things about HYSWEEP Interfacing	130
Appendix C: Interferometry Real-Time Processing	131
Appendix D: Pass Through Navigation	133
Appendix E: HYSWEEP with EM2040 Firmware 5 and KMALL.....	134

Update History:

- December, 2023 Norbit WBMS and Norbit Dual Head sections: Changing port values for primary and secondary heads.
- April, 2023 Updated R2Sonic sections: Added TruePix Water Column Data Logging option
- March, 2023 Added Valeport SWiFT SVP section
- January, 2023 HYPACK 2023 Release
 - Applanix POS M/V Network supports GSOF Messages.
 - Revised Hydro-Tech Multibeam driver.
 - Option to invert pitch sign in iXblue driver.
 - Kongsberg KMALL driver.
 - NORBIT Dual Head and WBMS: Added Send Start/Stop Logging Commands option
- April, 2022 Added CodaOctopus F290 (COMPAC)
- January, 2022 Include Seabat T51 Multibeam
- August, 2021 Updated Leica Laser to individual models and new setup and control forms
- March, 2021
 - Add Imagenix AUV, Ouster OS-1, and Optech Polaris
 - Add Odom MB2 notes. Shows up under "Reson Odom MB2".
- January, 2021 HYPACK 2021 release.
 - NORBIT and Reson drivers: Rotator (pan/tilt) and GPS pass through.
 - Reson dual head driver: Sidescan merge.
 - Kongsberg EM2040: KMALL support.
 - Appendix D for pass through navigation.
- October, 2019 Add SBG driver info.
- February, 2019 Add Velodyne laser quality codes, add Advanced Navigation INS driver.
- February, 2018 Generic Attitude support for parsing timetag.
- February, 2018 Norbit WBMS multibeam, Norbit Dual Head
- February, 2018 Reson Dual Head updates for IDH (Integrated Dual Head)
- October, 2017 Renishaw SLM product is now called the Carlson Merlin
- January, 2017 Added Leica P20 section
- May, 2016 Added Klein 5000, Trittech Gemini, Picotech sections.
- April, 2015 Updated Optech section. Added PingDSP & Velodyne sections.
- February, 2015 Added ME70. Few minor changes to MDL, Edgetech 6205.
- March, 2014 Check and update notes for various drivers.
- December, 2013 Updated setup form in Reson Seabat drivers.
- August, 2013 Add Novatel section. Add Klein 3500 section.

- July, 2013 Add R2Sonic Dual Head, Seabat 7160. Update Odom MB1 Dual Head.
- June, 2013 Revise Simrad and MDL sections
- April, 2013 Revise RIEGL and R2Sonic (TruePix) sections
- April, 2013 Add Odom MB1 dual head and Imagenex DT100.
- June, 2011 Add Odom MB1 section. Update Blueview section per driver changes.
- September, 2010 Added RIEGL V Series section
- April, 2010 Added Kongsberg MS 1000 section
- March, 2010 R2Sonic driver update.
- November, 2009 Update Swathplus, C3D, GeoSwath, Edgetech 4600. Add Appendix C.
- August, 2009 Include R2Sonic driver.
- December, 2008 Include FURUNO and JAE drivers.
- October, 2008 Additional notes on Delta T / ES3. Dual head Delta T / ES3. Seabat 7101.
- September, 2008 POS/MV network updates.
- April, 2008 Seabat 7125 driver changes.
- March, 2008 Update Benthos section for new driver
- March, 2008 Include Seabat 7125 dual head and BlueView multibeam
- January, 2008 Restore missing RIEGL LMS-Q120 section.
- November, 2007 Include Simrad EM710 and EM302 drivers. Updates to Atlas drivers.
- January, 2007 Include Simrad EM3002D driver.
- November, 2006 Include POS/MV and Delta T drivers.
- August, 2006 Include Coda-Octopus F180.
- December, 2005 Include Reson Seabat 7125.
- August, 2005 Additional notes on Tritech Sea King.
- March, 2005 Include GeoAcoustics GeoSwath.
- November, 2004 Include Simrad EM3002.

Advanced Navigation INS Network

HYSWEEP driver for heave, pitch, roll and heading data using UDP interface. This is normally data looped back from the HYPACK survey driver.

Connection:

UDP network port = 5656

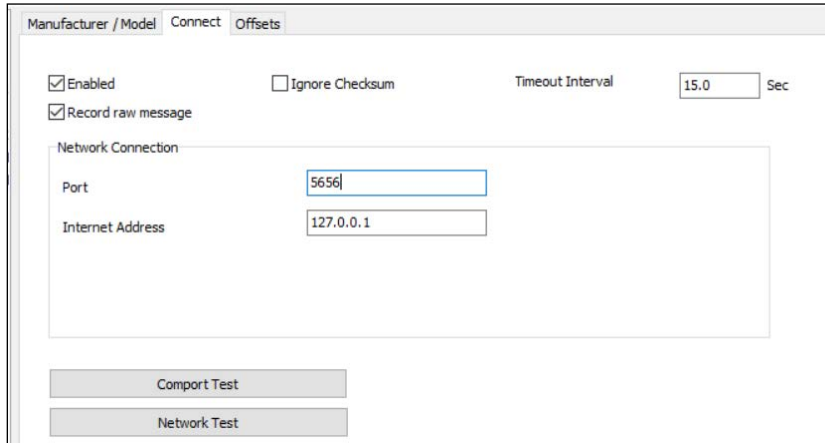

The screenshot shows a software window with three tabs: "Manufacturer / Model", "Connect", and "Offsets". The "Connect" tab is active. It contains the following settings:

- Enabled
- Ignore Checksum
- Timeout Interval: 15.0 Sec
- Record raw message
- Network Connection section:
 - Port: 5656
 - Internet Address: 127.0.0.1
- Comport Test button
- Network Test button

Offsets - MRU:

Starboard:

IMU reference point location starboard of **boat center**.

Forward:

IMU reference point location forward of **boat center**.

Vertical:

IMU reference point location relative to waterline (positive below).

Yaw:

Enter 0.

Pitch, Roll:

Enter 0 (IMU pitch/roll offsets are typically zeroed within the IMU itself).

Latency:

Enter 0.

Offsets - Gyro:

Enter 0 for all offsets and latency.

Advanced Navigation INS Serial

HYSWEEP driver for heave, pitch, roll and heading data using serial interface.

Connection:

COM port interface.

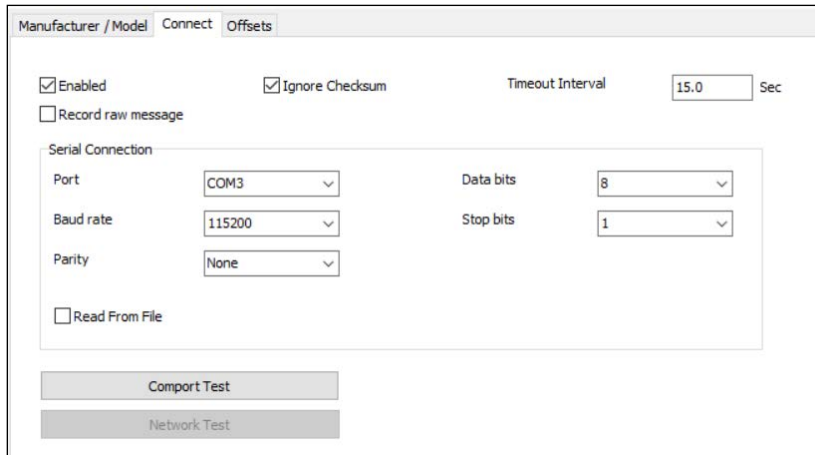

The screenshot shows a software window with three tabs: "Manufacturer / Model", "Connect", and "Offsets". The "Connect" tab is active. It contains the following settings:

- Enabled
- Ignore Checksum
- Timeout Interval: 15.0 Sec
- Record raw message
- Serial Connection section:
 - Port: COM3
 - Data bits: 8
 - Baud rate: 115200
 - Stop bits: 1
 - Parity: None
 - Read From File
- Comport Test button
- Network Test button

Offsets - MRU:

Starboard:

IMU reference point location starboard of **boat center**.

Forward:

IMU reference point location forward of **boat center**.

Vertical:

IMU reference point location relative to waterline (positive below).

Yaw:

Enter 0.

Pitch, Roll:

Enter 0 (IMU pitch/roll offsets are typically zeroed within the IMU itself).

Latency:

Enter 0.

Offsets - Gyro:

Enter 0 for all offsets and latency.

AML 3 & 6

Driver for SV Profiler. Also can get data from the device via the Sound Velocity program or exporting from AML's Sailfish program to HYPACK's sound velocity format

Setup Form:

None

Connection:

Nothing needs to be set for the connection on the HYSWEEP just clicking the button in the form to connect to the device. However you must either manually connect to it via Wi-Fi or connect to it with AML's Sailfish program. To connect to it manually the password is the serial number repeated twice. You can find the serial number in the Wi-Fi's name after "AML_", example AML_A13003's password would be A13003A13003.

Notes:

Before taking a cast be sure to make sure the LED is solid green not blinking, otherwise, you'll log with a Latitude of 0 and get bad depths for the readings. Should only take about 60-90 seconds to get a GPS lock.

Analog Sidescan

Driver providing 2-channel sidescan information from analog input. A separate program (Ascan.exe) is run automatically to sample the ping trigger and digitize the analog inputs. The digitized data are passed to HYSWEEP Survey through shared memory.

Setup Form:

There is no setup form in HYSWEEP Hardware. However, clicking “Analog Sidescan Monitor” (on the taskbar) during HYSWEEP Survey will show the following form for sidescan configuration on the fly.

Input: Select one of the voltage range options.

Trigger: Ping is on low to high or high to low transition of the trigger signal.

Gain: Gain constant (voltage multiplier).

Threshold: This is the A/D count level at which triggering occurs.

Test: Simulate data provides a dummy amplitude time series for each channel.

Connection:

Connected via a National Instruments multifunction I/O device – PCI board or PCMCIA card. The device is plug and play – no configuration required.

Offsets – Sonar Heads 1 and 2:

Starboard: Sonar head locations starboard of boat center.

Forward: Sonar head locations forward of **boat center**.

Vertical: Sonar head locations relative to waterline (positive).

Yaw, Pitch, Roll. Latency: Enter 0.

Notes:

See Appendix A: Analog Sidescan Interfacing.

The screenshot shows the 'Analog Sidescan Monitor' window. It features several configuration sections: 'Input' with radio buttons for '+/- 5V' and '0 - 10V'; 'Gain' and 'Ping Number' text boxes with values 1.00 and 0; 'Trigger' with radio buttons for 'Low -> High' and 'High -> Low'; and a 'Threshold' spin box set to 880. Below these are three data display areas for 'Trigger', 'Channel 1', and 'Channel 2', each showing a scale from 0 to 4096 with a red horizontal line at the current value. At the bottom, there is a 'Test' section with a 'Simulate Data' checkbox, an error message 'DAQ_DB_HalfReady Error = -10401', and 'Restore Default Values' and 'Apply' buttons.

Applanix POS MV Network

HYSWEEP driver for POS MV heave, pitch, roll and heading data using the network interface. Also supports POS LV with alternate settings (below).

Setup Form:

Use Group 102 in normal operation for heave, pitch, roll and heading. Use GSOF 65 to output the same data as Group 102, but as GSOF messages. Use group 1 in the specific case of POS LV, which does not provide heave measurements.

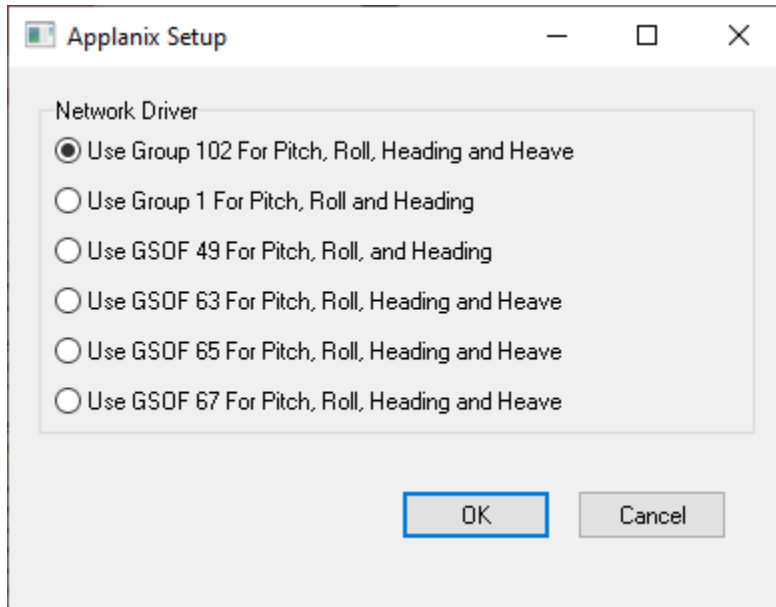

Connection:

Network interface using the following settings in HYSWEEP hardware: Port = 5602, IP Address = 127.0.0.1.

Offsets - MRU:

Starboard:

POS MV IMU location starboard of **boat reference**.

Forward:

POS MV IMU location forward of **boat reference**.

Vertical:

POS MV IMU location relative to waterline (positive below).

Yaw:

Enter 0.

Pitch, Roll:

Enter 0 (pitch/roll offsets are typically zeroed within the POS MV itself).

Latency:

Enter 0.

Offsets - Gyro:

Enter 0 for all offsets and latency.

Notes:

Setup in POS MV:

Using the Logging menu of the POSView program, select output groups 3, 7 and 102 at 25 Hz. The data rate is high enough for motion compensation while not so high as to lead to huge data files.

If using POS MV version 4, select output group 20 for GPS status information.

If using POS LV use Group 1 instead of 102.

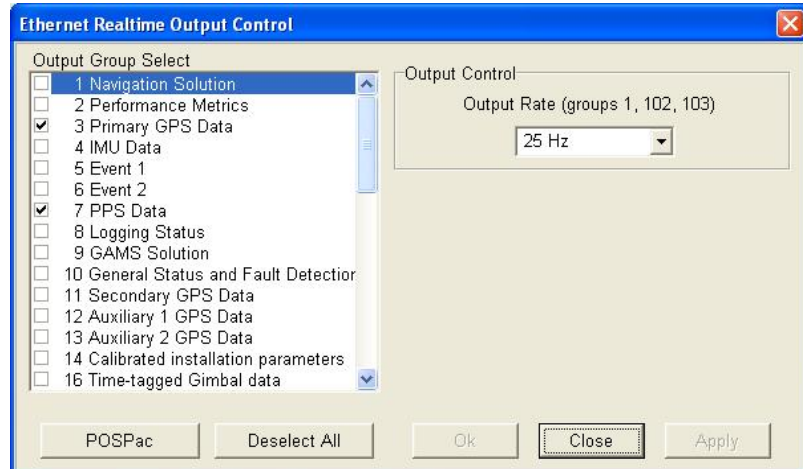

Setup in HYPACK Hardware:

General Settings

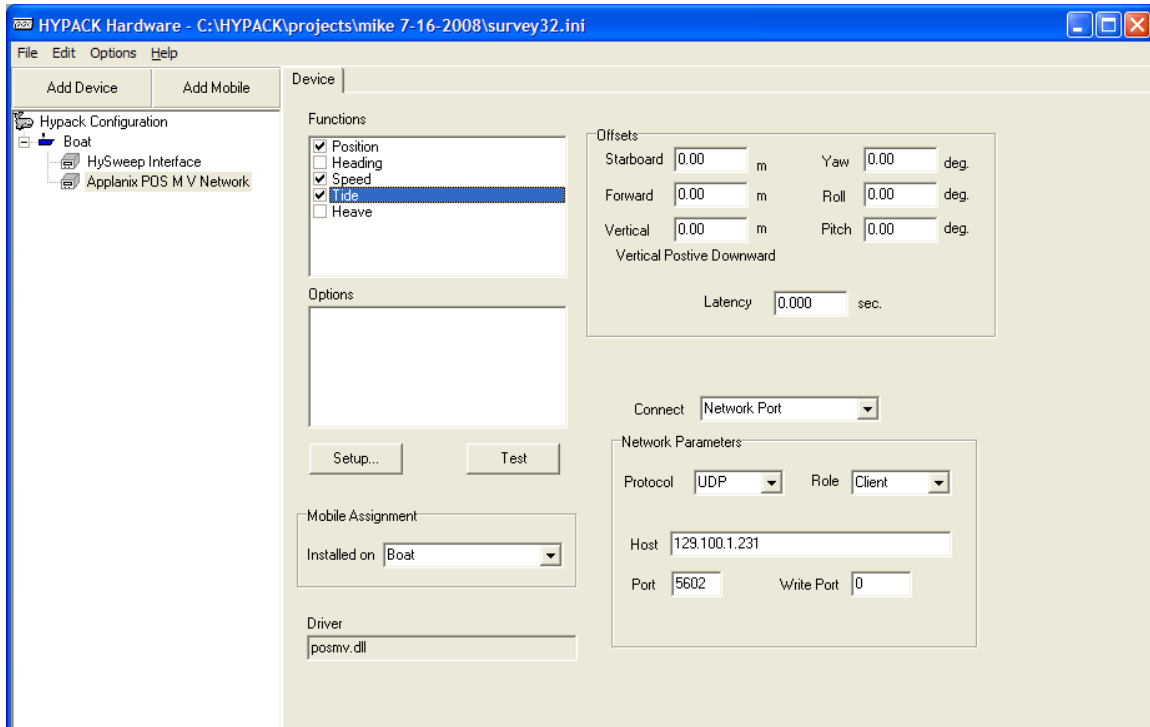

Setup Button:

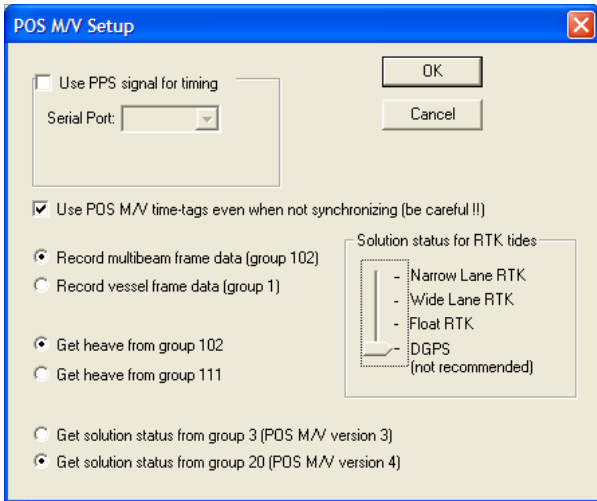

Applanix POS/MV Serial

HYSWEEP driver for POS/MV heave, pitch, roll and heading data using serial interface.

Setup Form:

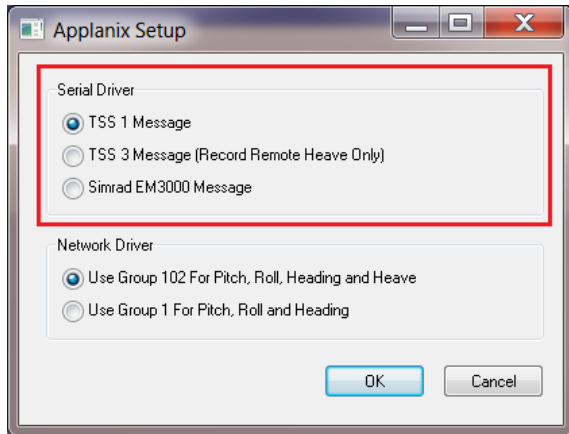

Select TSS 1 Message for the text output message – heave, pitch and roll string similar to the DMS/05.

Select TSS 3 Message to record remote heave instead of total heave as with the TSS1 message.

Select Simrad EM3000 Message for binary output containing heave, pitch, roll *and* heading.

Connection:

RS232 Serial interface.

Offsets - MRU:

Starboard:

MRU location starboard of **boat center**.

Forward:

MRU location forward of **boat center**.

Vertical:

MRU location relative to waterline (positive below).

Yaw:

Enter 0.

Pitch, Roll:

Enter 0 (MRU pitch/roll offsets are typically zeroed within the MRU itself).

Latency:

Enter 0.

Offsets - Gyro:

Enter 0 for all offsets and latency.

Notes:

Supersedes TSS POS/MV driver.

Atlas Bomasweep

Driver providing heading and depth from a 41 transducer system.

Setup Form:

Heading from the Bomasweep is optional.

Connection:

RS232 Serial interface.

Message record is shown below:

```
SZ7202 10125471 00000000000 000000000 000000 127500 000000 0000 0001 000 00 00211 033 000
00318 1 00319 1 00320 1 00315 1 00300 1 00310 1 00305 1 00305 1 00297 1 00277 1 00273 1 00279 1
00286 1 00289 1 00286 1 00293 1 00300 1 00314 1 00320 1 00332 1 00343 1 00347 1 00351 1 00372 1
00380 1 00388 1 00401 1 00403 1 00409 1 00427 1 00423 1 00426 1 00430 1 00435 1 00432 1 00438 1
00428 1 00451 1 00444 1 00424 1 00404 1
```

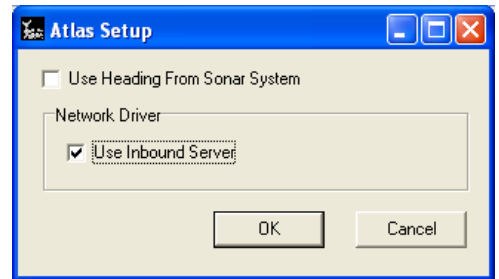

Offsets - Heading:

All heading offsets are 0 with the exception of Yaw, which is based on the patch test results.

Offsets – Transducers 1 through 41:

Starboard: Transducer position starboard of boat center.

Forward: Transducer position forward of **boat center**.

Vertical: Transducer draft (positive).

Yaw, Pitch, Roll: All zeros.

Latency: Enter the latency time (positive, seconds) appropriate for each transducer.

Notes:

Atlas Fansweep (Network), Hydrosweep MD2 (HYPACK 2009A and Earlier)

HYSWEEP driver for the Atlas Fansweep 15 and 20. Also works with medium depth system MD2. Provides roll corrected multibeam soundings, beam intensity values, port and starboard sidescan images and HPR compensation data.

Setup Form:

Use Heading From Sonar System: User can select whether or not to use heading from the Fansweep.

Use Inbound Server: If selected, datagram transfer uses a server application from Atlas. If deselected, datagram transfer is direct into the driver. Both methods work – the Inbound Server method is preferred as it has had more testing.

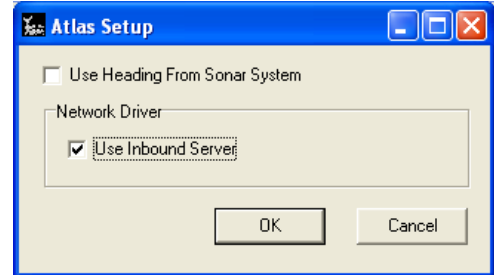

Connection:

Only applicable if the Inbound Server is not used. Set default Internet Address (127.0.0.1) and Port number to match that set in the Fansweep control computer (20000 in one installation).

Offsets - MRU:

Starboard: MRU location starboard of **boat center**.

Forward: MRU location forward of **boat center**.

Vertical: MRU location relative to waterline (positive below).

Yaw: Enter 0.

Pitch, Roll: Enter 0 (MRU pitch/roll offsets are typically zeroed within the MRU itself).

Latency: Enter 0.

Offsets – Sonar Heads 1 and 2:

Starboard: Sonar head locations starboard of **boat center**.

Forward: Sonar head locations forward of **boat center**.

Vertical: Sonar head locations relative to waterline (positive).

Yaw, Pitch, Roll: Sonar head rotations - enter values determined by patch testing unless already entered in the Fansweep (see note).

Latency: Enter 0.

Notes:

- If sonar yaw, pitch and roll offsets are entered in the Fansweep, they must not be repeated in HYSWEEP setup.

Atlas Fansweep, Hydrosweep MD2, MD/30, MD/50, DS (HYPACK 2010 and Later)

HYSWEEP driver for Atlas multibeam systems. Provides roll and possibly pitch corrected soundings, beam intensity values, port and starboard sidescan images and HPR and heading data.

The Fansweep and Hydrosweep MD2 are roll corrected. The Hydrosweep MD/30, MD/50 and DS are roll and pitch corrected.

Setup Form:

Use Heading From Sonar System: User can select whether or not to use heading from the multibeam system.

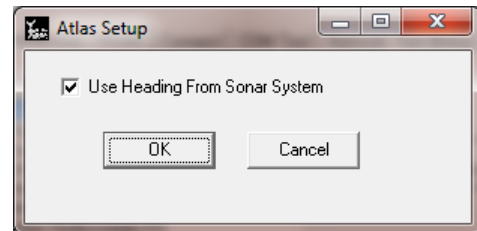

Connection:

HYSWEEP does not have a direct serial or network connection to the multibeam system. Instead, the connection is via software provided by Atlas.

1. HMCOM.DLL
2. UDPInboundServer (Windows Service).

Atlas install files are available from Rolf Alfke (Rolf.Alfke@atlas-elektronik.com).

Offsets - Heading:

Yaw: Enter the heading correction, or zero if no correction.

Offsets - MRU:

Starboard: MRU location starboard of **boat center**.

Forward: MRU location forward of boat center.

Vertical: MRU location relative to waterline (positive below).

Yaw: Enter 0.

Pitch, Roll: Enter 0 (MRU pitch/roll offsets are typically zeroed within the MRU itself).

Latency: Enter 0.

Offsets – Sonar Heads 1 and 2:

Starboard: Sonar head locations starboard of **boat center**.

Forward: Sonar head locations forward of **boat center**.

Vertical: Sonar head locations relative to waterline (positive below).

Yaw – Enter value determined by patch testing.

Pitch – Enter value determined by patch testing unless already entered in Atlas Hydromap.

Roll – Enter zero in HYSWEEP. Roll correction is always entered in Atlas Hydromap.

Latency: Enter 0.

Notes:

- Make sure not to enter yaw, pitch and roll offsets in both HYSWEEP and Hydromap. One or the other.
- Do not worry about double correcting for roll and pitch. That's taken care of.

- Quality Codes: Atlas codes sounding quality 0 = best to 5 = worst. HYSWEEP requires it the other way around. Here is the conversion.

<u>Atlas Code</u>	<u>HYSWEEP Code</u>	<u>Sounding Quality</u>
0	5	EXCELLENT
1	4	VERY_CREDIBLE
2	3	CREDIBLE
3	2	LESS_CREDIBLE
4	1	NOT_CREDIBLE
5	0	UNUSABLE

Atlas Fansweep (Serial)

Driver providing depth and HPR compensation from the Fansweep multibeam using a serial interface. This driver will eventually be replaced by a network driver.

Setup Form:

No specific setup for this driver.

Connection:

RS232 Serial interface. Message data is binary.

Offsets - MRU:

Starboard: MRU location starboard of **boat center**.

Forward: MRU location forward of **boat center**.

Vertical: MRU location relative to waterline (positive below).

Yaw, Pitch, Roll: MRU rotations relative to forward and vertical.

Latency: Enter the MRU latency time if any - positive, seconds.

Offsets – Sonar Head

Starboard: Sonar head location starboard of **boat center**.

Forward: Sonar head location forward of **boat center**.

Vertical: Sonar head location relative to waterline (positive).

Yaw, Pitch, Roll: Sonar head rotations relative to forward and vertical. Enter values determined by patch testing.

Latency: Enter 0 – latency is automatically compensated.

Notes:

BlueView BV5000

The BV5000 is a 3D scanning sonar with pan & tilt capabilities. Because of the pan & tilt nature and the relatively short range of the device, the data is logged as XYZI as if from a laser device.

Connection:

TCP Network connection. The address and port are configurable in the BlueView ProScan software. The driver communicates with ProScan which must be running at the same time as HYSWEEP.

Notes:

Below are screenshots of how to configure ProScan properly for GPS time sync and network communication:

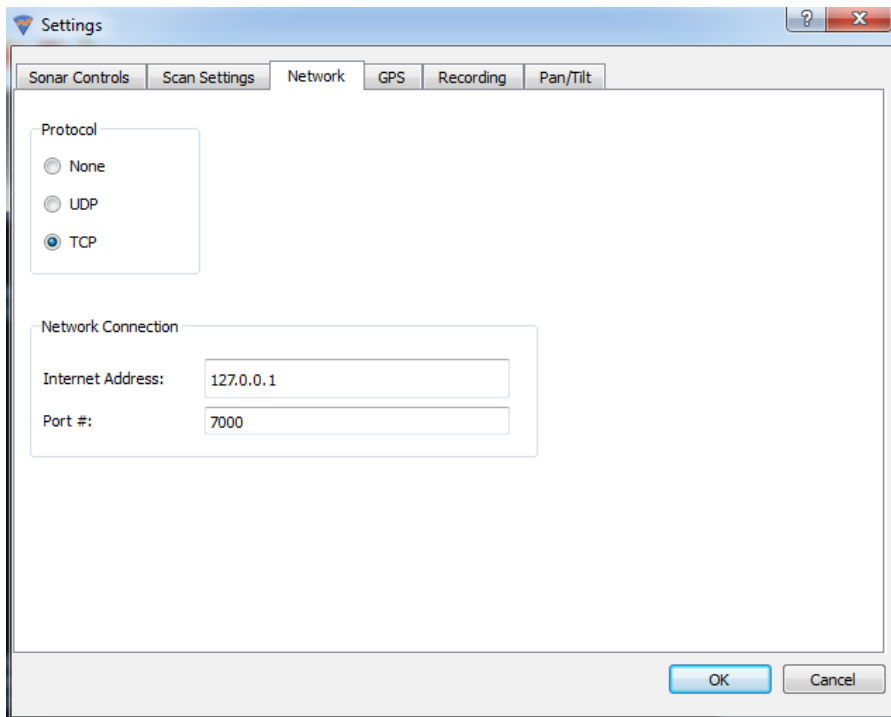

Settings

Sonar Controls Scan Settings Network **GPS** Recording Pan/Tilt

PPS Port

Port COM5

Port Setup

Detect PPS on rising edge only

Use PPS port for ZDA input

ZDA Port

Port

Port Setup

Use Sonar's Onboard PPS Timestamps

OK Cancel

The image shows a software settings window titled "Settings" with a blue header bar. Below the header is a tabbed interface with six tabs: "Sonar Controls", "Scan Settings", "Network", "GPS" (which is selected and highlighted), "Recording", and "Pan/Tilt". The main content area is divided into two sections. The first section is titled "PPS Port" and contains a "Port" dropdown menu currently set to "COM5" and a "Port Setup" button below it. Below this section are two checkboxes: "Detect PPS on rising edge only" (unchecked) and "Use PPS port for ZDA input" (checked). The second section is titled "ZDA Port" and contains an empty "Port" dropdown menu and a "Port Setup" button below it. At the bottom of the window, there is a checkbox for "Use Sonar's Onboard PPS Timestamps" which is checked, and two buttons: "OK" and "Cancel".

BlueView Multibeam

HYSWEEP driver for Blue View Technology multibeam systems. A number of systems are supported by this driver; MB1350-90, MB2250-90, etc.

Connection:

TCP Network connection.

- Port – Use 7000.
- Internet Address – Address of BVT controller.

Notes:

Device Control is no longer available.

Benthos C3D

HYSWEEP driver for the C3D Multibeam / Sidescan device. Provides multibeam soundings, beam intensity values and sidescan.

Connection:

All data is via a network interface. Internet address was pre-defined in previous driver version (pre HYPACK 2008). Now, internet address is configurable. Typically, it will be 127.0.0.1, but it could be different if the C3D Control Panel is run on a different computer. Port numbers are hard-coded in the driver so the 'port' field is ignored. However, note that the port number used is different for pole-mounted and towed systems so be sure to set the 'On Towfish' option in Hardware correctly.

Setup Form:

Each ping, the C3D sends thousands of range / angle / amplitude samples to HYSWEEP survey. These are reduced to a manageable number of beams in HYSWEEP Survey using the filtering and downsampling routines available in the HYSWEEP Interferometry window (See [Appendix C](#)).

K8E format files can be logged alongside HSX by checking the "Record Raw Message" option on the Connect tab.

By default the driver will read motion and CTD data coming from the C3D via separate UDP messages. However, if motion data should be read from the ping header, check the appropriate option in the set up form. If the C3D is pole-mounted, the Generic Attitude parser should be used to handle the CTD data coming into HYPACK via a serial connection. The C3D expects this CTD data to be relayed back via UDP port 4020 by the Generic Attitude parser (see the Generic Attitude parser section for more information).



Offsets – Sonar Heads 1 and 2:

Starboard: Sonar head locations starboard of **boat center**.

Forward: Sonar head locations forward of **boat center**.

Vertical: Sonar head locations relative to waterline (positive).

Yaw, Pitch, Roll: Sonar head rotations - enter values determined by patch testing.

Latency: Enter 0.

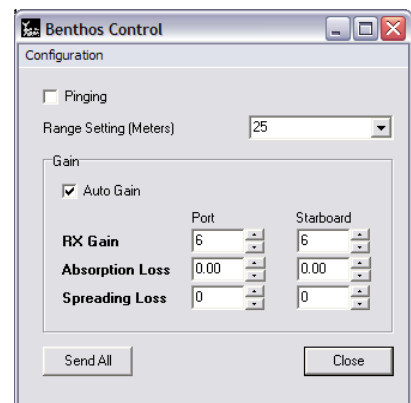

Notes:

At some point in 2008, Benthos changed how the C3D reports timing information. C3D users should make sure their sonar is up to date with Benthos and use HYSWEEP.exe/swpware.exe version 9.0.9 or later to be sure pings are timetagged properly.

Carlson Merlin

HYSWEEP driver for the Carlson Merlin laser scanner. The device offers a 360 degree swath and up to 0.01 degree resolution. This device and its HYPACK driver were formerly known as:

- Renishaw SLM
- Renishaw Merlin
- MDL Dynascan

Setup Form:

None. Use the runtime controller to configure the resolution and rotation speed.

Connection:

Via a network interface. The Internet Address is 192.168.0.10 and port 30 by default.

Notes:

The driver requests the "X1" data format from the SLM which includes PPS timestamped data, if the device firmware does not support this, arrival time is used to timetag points. The timetag of the first point is used as the ping time. Subsequent points are assigned a delay relative to ping time.

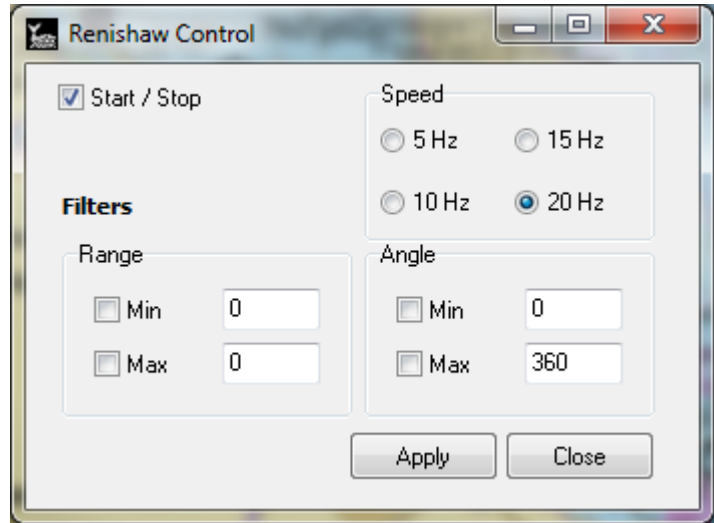

Coda-Octopus F180

Provides heave, pitch, roll and heading via a network interface.

Setup Form:

The driver takes in data at 100 Hz. Even in the most extreme pitch and roll condition, 25 Hz sampling should be sufficient and you can decrease file size by selecting the 25 Hz option.

Connection:

Network connection. Use 3000 for network port and the default internet address of 127.0.0.1. The F180 address is 195.0.0.180 and your network card must have an address that will receive data (195.0.0.181 for example)

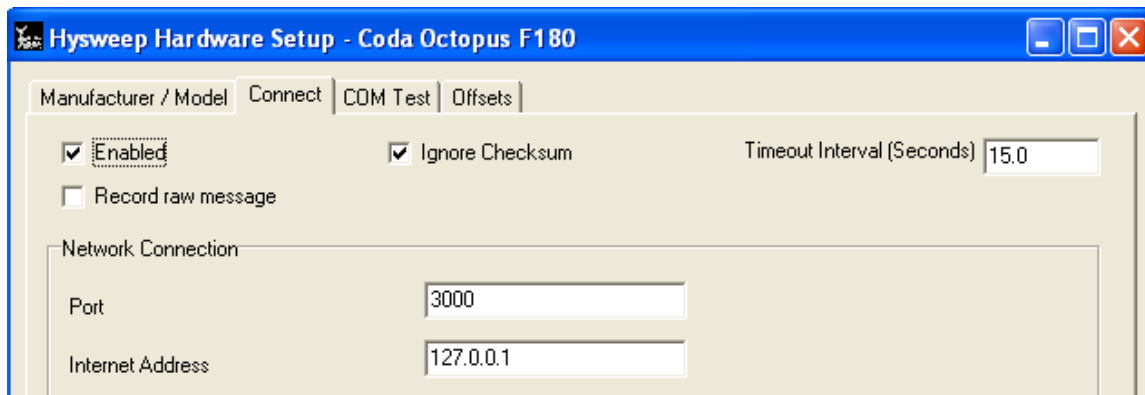
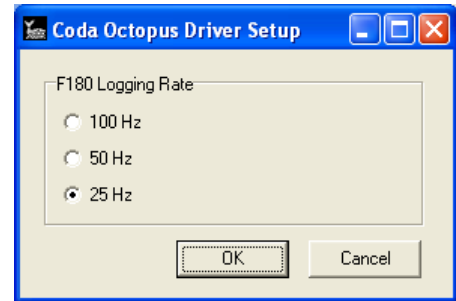

Offsets – MRU (Pitch/Roll):

Starboard: MRU location starboard of **boat center**.

Forward: MRU location forward of **boat center**.

Vertical: MRU location relative to waterline (positive below).

Yaw, Pitch, Roll: MRU rotations relative to forward and vertical.

Latency: Enter 0.

Offsets – Gyro (Heading)

Enter 0 for all.

Notes:

- When using this driver in HYSWEEP, it is likely the F180 network driver will be used in HYPACK survey. The F180 driver requires a 1PPS box for time synchronization.

To use delayed heave, start logging in the F180 controller at least 10 minutes before any HYPACK / HYSWEEP logging. When finished surveying, use the F180 option to stop logging after iHeave delay. The *.CSV files are used for heave corrections; *.MCOM files may be deleted.

Coda-Octopus F290

Provides heave, pitch, roll and heading via a network interface.

Setup Form:

The driver takes in data at 100 Hz. Even in the most extreme pitch and roll condition, 25 Hz sampling should be sufficient and you can decrease file size by selecting the 25 Hz option.

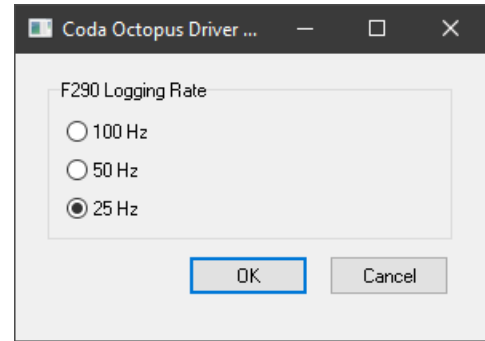

Connection:

Network connection. Use 50000 for network port and the default internet address of 127.0.0.1. The F180 address is the device serial number and your network card must have an address that will receive data (the first 3 parts of the IP address are shared, while the last part must differ)

Offsets – MRU (Pitch/Roll):

Starboard: MRU location starboard of **boat center**.

Forward: MRU location forward of **boat center**.

Vertical: MRU location relative to waterline (positive below).

Yaw, Pitch, Roll: MRU rotations relative to forward and vertical.

Latency: Enter 0.

Offsets – Gyro (Heading)

Enter 0 for all.

Notes:

- When using this driver in HYSWEEP, it is likely the F290 network driver will be used in HYPACK survey. The F290 driver requires a 1PPS box for time synchronization.
- To use delayed heave, start logging in the F290 web interface at least 10 minutes before any HYPACK / HYSWEEP logging. When finished surveying, use the F290 option to stop logging after iHeave delay. The *.CSV files are used for heave corrections; Any COMPAC files may be deleted.

Edgetech 4600/6205

HYSWEEP driver for the Edgetech 4600 interferometer. Provides multibeam soundings, beam intensity, beam quality, and sidescan imagery. HYSWEEP also reads mru and gyro data from the Edgetech data stream.

There is also a sister driver to read navigation from Edgetech in HYPACK called nav4600.dll. This allows all data from Edgetech to be timetagged **by** Edgetech.

Connection:

All data is via a network interface (TCP). Set the Internet Address to the IP of the multibeam. Set the port to 1900--the control port. The driver also uses port 1901 for data. The nav4600.dll driver mentioned above should be set to port 1902. Edgetech broadcasts navigation only on this port.

Offsets:

Starboard: Sonar head locations starboard of **boat reference**.

Forward: Sonar head locations forward of **boat reference**.

Vertical: Sonar head locations relative to waterline (positive).

Yaw, Pitch, Roll: Sonar head rotations - enter values determined by patch testing.

Latency: Enter 0.

Notes:

This is the first driver to use new the Interferometry interface in HYSWEEP. The interface intends to standardize the filtering and downsampling/binning routines used on such data. Modify the processing settings with the Interferometry window from the View menu.

FURUNO HS Series Multibeam

HYSWEEP driver for the FURUNO HS-300F, HS-600, and HS-600F multibeams. Provides multibeam soundings, beam intensity values and sidescan imagery. FURUNO provides a beam quality number between 0--3.

Connection:

All data is via a network interface (TCP). Set the Internet Address to the IP of the multibeam. The default port is 9000.

Offsets:

Starboard: Sonar head locations starboard of **boat reference**.

Forward: Sonar head locations forward of **boat reference**.

Vertical: Sonar head locations relative to waterline (positive).

Yaw, Pitch, Roll: Sonar head rotations - enter values determined by patch testing.

Latency: Enter 0.

Notes:

Generic Attitude

Driver providing pitch, roll and/or heading from serial devices for which there is no HYSWEEP driver. It can also parse CTD information. The 'output strings to UDP port' option will broadcast incoming strings to the network port you specify.

Setup Form:

Enter device capabilities, parsing information and output script.

Connection:

RS232 Serial interface. Message must be in ASCII.

Offsets – MRU (Pitch/Roll):

Starboard: MRU location starboard of **boat center**.

Forward: MRU location forward of **boat center**.

Vertical: MRU location relative to waterline (positive below).

Yaw, Pitch, Roll: MRU rotations relative to forward and vertical.

Latency: Usually 0 for pitch and roll devices.

Offsets – Gyro (Heading)

Starboard, Forward, Vertical: Enter 0.

Yaw: Enter offset if any.

Pitch, Roll: Enter 0.

Latency: Usually 0 for heading devices.

Notes:

If selected, time is derived from the incoming sentence; otherwise, Veritime is used. Accurate timing of attitude data is of critical importance and if a high-accuracy timetag exists in the incoming data, it would be preferable to use it over message arrival time which is affected by various latencies.

Time can be represented in myriad ways. For now, this driver will support the HHMMSS.sss format used in NMEA as this is a common format that customers are likely to want to parse. In particular, the NMEA-compliant "PASHR" string can be parsed in this way.

Separated Fields		
	Field Number (1=1st)	Multiplier
<input type="checkbox"/> Time	0	
<input type="checkbox"/> Pitch	0	0.000
<input type="checkbox"/> Roll	0	0.000
<input type="checkbox"/> Heading	0	0.000
<input type="checkbox"/> Heave	0	0.000
<input type="checkbox"/> Sound Velocity	0	0.000
<input type="checkbox"/> Depth	0	0.000
<input type="checkbox"/> Pressure	0	0.000
<input type="checkbox"/> Temperature	0	0.000
<input type="checkbox"/> Salinity	0	0.000

GeoAcoustics GeoSwath

HYSWEEP driver for the GeoSwath multibeam / sidescan device. Provides multibeam soundings, beam intensity values and sidescan imagery.

Setup Form:

Each ping, the GeoSwath sends thousands of range / angle / amplitude samples to HYSWEEP survey. These are reduced to a manageable number of beams in HYSWEEP Survey using the filtering and downsampling routines available in the HYSWEEP Interferometry window (See [Appendix C](#)).

RDF format files can be logged alongside HSX by checking the "Record Raw Message" option on the Connect tab.

Connection:

All data is via a network interface. Internet address can be left as 127.0.0.1. Use network port 5001. In 2010, the filtering features from the IFFilter program are built into HYSWEEP so this program is no longer needed for real-time operation.

Offsets - MRU:

Starboard: MRU location starboard of **boat reference**.

Forward: MRU location forward of **boat reference**.

Vertical: MRU location relative to waterline (positive below).

Yaw, Pitch, Roll: Enter MRU calibration offsets if not entered elsewhere.

Latency: Enter 0.

Offsets - Gyro:

Starboard, Forward, Vertical: Enter 0.

Yaw: Typically 0.

Pitch, Roll, Latency: Enter 0.

Offsets – Sonar Heads 1 and 2:

Starboard: Sonar head locations starboard of **boat reference**.

Forward: Sonar head locations forward of **boat reference**.

Vertical: Sonar head locations relative to waterline (positive).

Yaw, Pitch, Roll: Sonar head rotations - enter values determined by patch testing.

Latency: Enter 0.

Notes:

- Two computers are required; One runs GeoSwath +, which is the control program. The other runs HYPACK / HYSWEEP. Communication is over the Ethernet cable.
- The computers must be time synchronized. This is done by time synchronizing both to GPS time (requiring a HYPACK 1PPS box).

- in HYSWEEP 10.0.13 and later, the driver supports the 500kHz GeoSwath as well. It will attempt to detect the frequency, but you can force this mode by setting `Geo500kHz=1` in the section for the GeoSwath of your HYSWEEP.ini.

Hydro-Tech Multibeam

Multibeam sonar driver, Hydro-Tech Marine Technology. Interfacing is through HydroQuest.exe sonar control program provided by Hydro-Tech. HydroQuest runs on the same computer as HYPACK.

Setup Form:

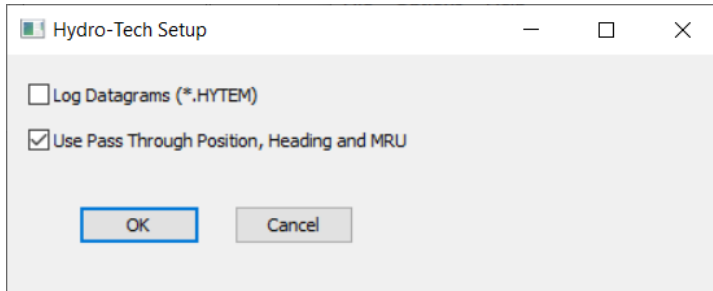

Hydro-Tech Setup

Log Datagrams (*.HYTEM)

Use Pass Through Position, Heading and MRU

OK Cancel

- Log Datagrams (*.HYTEM), unchecked by default and usually not required. When checked the driver logs raw datagrams to file to help with debug. HYTEM is the Hydro-Tech datagram format.
- Use Pass Through Position, Heading and MRU, checked by default. When checked heading and motion datagrams from the embedded IMU are parsed then logged to HSX. Position data is passed to Hypack survey driver Hysweep_Extended.DLL. Hysweep_Extended.DLL is an **optional** and very basic GPS/INS driver which can be used to replace the native device driver (POS MV.DLL for example).

Connection:

TCP network interface, port 16129 to connect to HydroQuest control software.



Network Connection

Port 16129

Internet Address 127.0.0.1

IP setup for HydroQuest to sonar comms is as follows.

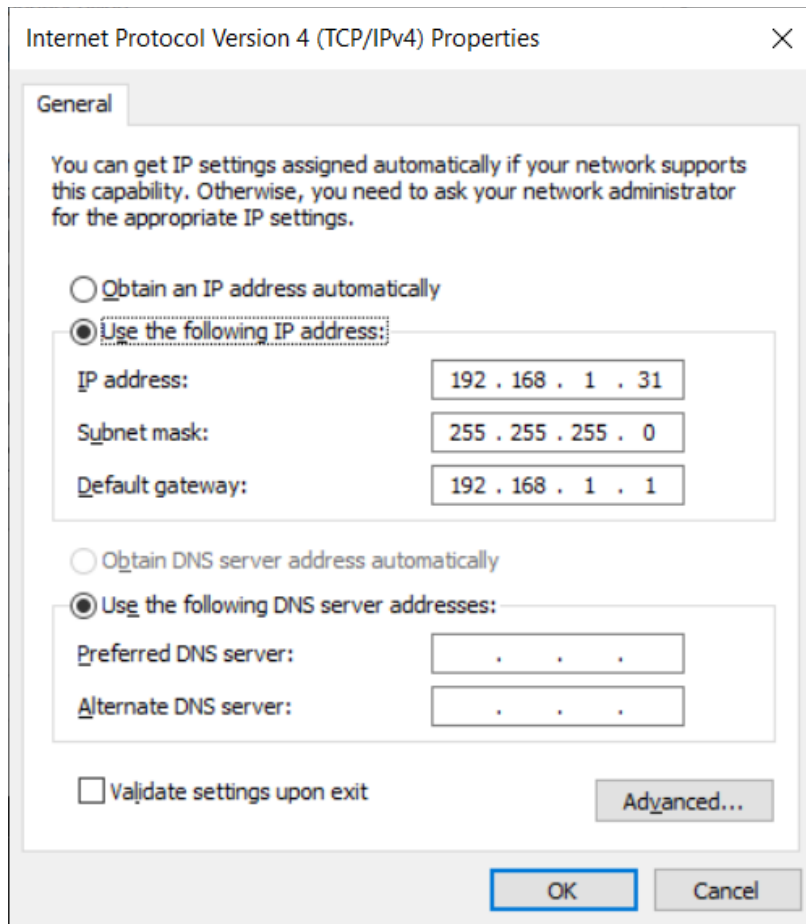

Notes:

A previous driver version used the R2Sonic datagrams. This is no longer support by Hydro-Tech or HYPACK.

HYPACK Navigation

HYSWEEP driver providing various HYPACK Survey data.

- Grid position and position time.
- GPS heading and speed.
- Single beam depth and events.
- Start / stop logging commands and HYPACK filenames.
- HYPACK tide and dynamic draft corrections.

Additional survey data may be transferred from HYSWEEP → HYPACK

- Targets.
- Heading, heave, pitch and roll compensation, nadir beam depth and matrix updates (requires HYPACK DLL, see HYPACK setup below).

Setup Form:

None.

Connection:

None required because data is exchanged through shared memory.

Offsets – Position Antenna:

Starboard: Antenna position starboard of **boat center**.

Forward: Antenna position forward of **boat center**.

Vertical: Antenna height relative to the waterline. This is a negative number when the antenna is above water.

Yaw, Pitch, Roll: Enter 0.

Latency: GPS latency (positive) as determined by patch testing and/or GPS manufacturer's documentation. Note that if the position latency is not-zero, it must be entered in the HYPACK *and* HYSWEEP setup programs.

Offsets – Gyro:

Starboard, Forward, Vertical: Enter 0.

Yaw – Typically 0.

Pitch, Roll: Enter 0.

Latency: Enter the latency time specified by the Gyro manufacturer (usually 0).

HYPACK Setup (using the HYPACK Hardware Program):

HYPACK Max Survey does not require a driver to send position and single beam soundings to HYSWEEP. A driver is required for HYPACK survey to *receive* heading, heave/pitch/roll, nadir depth and matrix updates from HYSWEEP survey: "HYSWEEP Interface" (HYSWEEP.dll). Heading and heave are useful to correct single beam soundings and to display the boat shape in the proper orientation. Nadir depth is often used by boat operators to judge under keel clearance.

Notes:

- If POS/MV heading is input to HYPACK, use the NMEA driver, select \$HDT message and *do not* select \$VTG message. If your heading data turns out spikey, it's because both \$VTG and \$HDT are selected.

Because only raw data is transferred from HYPACK to HYSWEEP, offsets are entered in *both* hardware setup programs.

Imagenex AUV

Driver for the Imagenex AUV sidescan sonar.

Connection:

Network interface. AUV control box has fixed IP Address 192.168.0.2 and uses port 4040. The HYPACK PC must use a compatible IP address; 192.168.0.3 for example.

Note: The AUV control box does not respond to ping commands.

Sonar Head Offsets:

Forward / Starboard: For hull mount, enter offsets relative to boat origin. For towfish, enter 0, 0 as offsets are applied to the tow cable driver (TOWCABLE.DLL) in HYPACK survey.

All Other Offsets: Enter 0.

Online Sonar Control:

You can set the frequency, range, and gain for this device.

Notes:

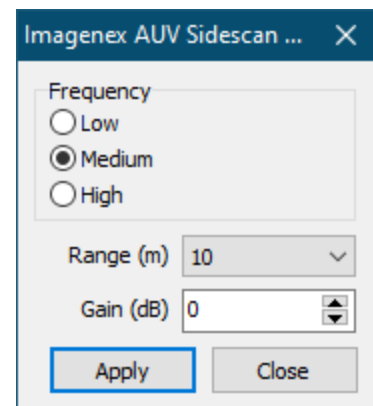

Imagenex Delta T

HYSWEEP driver for the Delta T multibeam. Provides multibeam soundings via a network interface.

Setup Form:

There are two methods of time tagging Delta T data; (1) PC arrival time or (2) UTC time. The arrival time method works fine but for more accurate time tags select the UTC method. If UTC time is used, auxiliary sensors (GPS, MRU, gyro) must be time synched to UTC also.

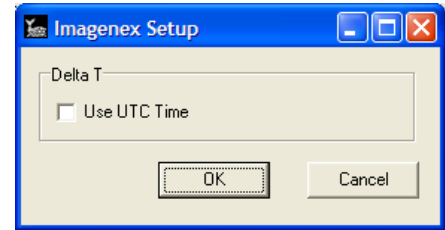

Connection:

All data is via a network interface. Set network card internet address 192.168.0.4, subnet mask 255.255.255.0. Set HYSWEEP connection as shown:

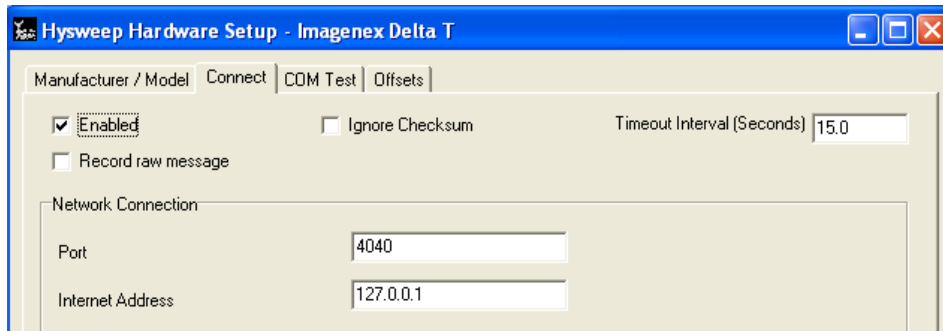

Sonar Offsets:

Starboard: Sonar head locations starboard of **boat reference**.

Forward: Sonar head locations forward of **boat reference**.

Vertical: Sonar head locations relative to waterline (positive).

Yaw, Pitch, Roll: Sonar head rotations - enter values determined by patch testing.

Latency: Enter 0.

Notes:

- Two computers are required; One runs the Delta T multibeam, the other runs HYPACK / HYSWEEP. Communication is over the Ethernet cable.
- Both computers must be time synchronized to UTC time if Delta T UTC time tagging is selected.
- The MRU should be connected to both computers. The Delta T does real-time roll corrections and provides roll corrected data. HYSWEEP needs the pitch and heave corrections.
- It is very easy to change the number of Delta T beams. Don't do it. Select the number you like (120 or 240, 480 seems excessive with it Changing number change in shallow water) and stick throughout the survey. sector size also changes of beams. If you do

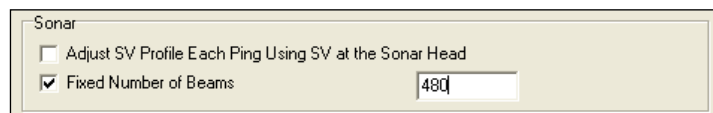

excessive with it Changing number change

the number of beams, you will need to fix number of beams to 480 in MBMAX post-processing (Advanced Read Parameters).

Imagenex Delta T – Dual Head

HYSWEEP driver for the dual head Delta T multibeam. All setup information for single head delta T applies with the exceptions:

Sonar Offsets:

Since there are two sonar heads, two sets of offsets that must be entered.

Imagenex DT100 SIR

HYSWEEP driver for the DT100 multibeam using SIR (Sensor Input Relay). Sonar, motion and heading data are time tagged and routed to HYSWEEP via the SIR.

Setup Form:

No specific setup required.

Connection:

Use Network Port 4040. Use Internet Address 127.0.0.1 or address of the SIR.

Offsets:

Sonar Head 1 – Enter sonar head location relative to boat reference. Enter patch test offsets. Latency should be 0.

MRU Offsets – Enter MRU location relative to boat reference.

Heading Offset (Yaw) – Enter yaw angle if needed for boat heading adjustment.

Notes:

- The SIR interface can be used with a Delta T as well as with DT100 sonar. When Delta T is connected via SIR, use this (not Delta T) driver.

IS Tech Multibeam

Provides multibeam soundings and side scan via a network interface.

Setup Form:

None.

Connection:

All data is via a network interface. Set network card internet address and port to the sonar.

Sonar Offsets:

- **Starboard:** Sonar head locations starboard of **boat reference**.
- **Forward:** Sonar head locations forward of **boat reference**.
- **Vertical:** Sonar head locations relative to waterline (positive).
- **Yaw, Pitch, Roll:** Sonar head rotations - enter values determined by patch testing.
- **Latency:** Enter 0.

Notes:

IXSEA Octans Network

HYSWEEP driver for the IXSEA Octans motion sensor. Provides heave, pitch, roll, and heading data.

Connection:

Network TCP interface, standard Octans message format.

Offsets – MRU (Pitch/Roll):

- **Starboard:** MRU location starboard of **boat center**.
- **Forward:** MRU location forward of **boat center**.
- **Vertical:** MRU location relative to waterline (positive below).
- **Yaw, Pitch, Roll:** MRU rotations relative to forward and vertical.
- **Latency:** Usually 0 for pitch and roll devices.

Offsets – Gyro (Heading)

- **Starboard, Forward, Vertical:** Enter 0.
- **Yaw:** Enter offset if any.
- **Pitch, Roll:** Enter 0.
- **Latency:** Usually 0 for heading devices.

Notes:

The Octans must be configured to output the ZDA message to properly timestamp data. The driver will throw an error if it doesn't see ZDA after 10 seconds.

IXSEA Octans Serial

HYSWEEP driver for the IXSEA Octans motion sensor. Provides heave, pitch, roll, and heading data.

Connection:

RS232 Serial interface, Octans Standard format.

Offsets – MRU (Pitch/Roll):

- **Starboard:** MRU location starboard of **boat center**.
- **Forward:** MRU location forward of **boat center**.
- **Vertical:** MRU location relative to waterline (positive below).
- Yaw, Pitch, Roll: MRU rotations relative to forward and vertical.
- **Latency:** Usually 0 for pitch and roll devices.

Offsets – Gyro (Heading)

- **Starboard, Forward, Vertical:** Enter 0.
- Yaw: Enter offset if any.
- **Pitch, Roll:** Enter 0.
- **Latency:** Usually 0 for heading devices.

Notes:

iXBlue IMU (Serial, TCP, UDP)

Hysweep driver for iXBlue IMU (Hydrins, Octans, etc)

Works with the following output protocols from iXBlue INS:

- Octans Standard
- Phins Standard
- Simrad EM
- IXSEA TAH
- Navigation long

Connection:

RS232 Serial interface, TCP or UDP

Setup:

Choose the relevant output in the IXBlue control software and set it in the driver setup

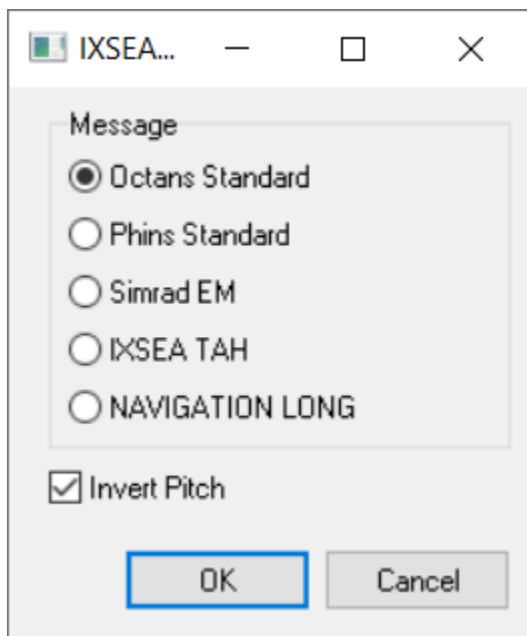

Choosing "Invert Pitch" will give pitch values matching the TSS standard (bow up positive), which is what HYSWEEP expects.

Notes:

When using the TAH protocol the driver parses the first heave which is eFF.FFF (Heave with Primary Lever arms applied in meters). The second eHH.HHH (Heave with Chosen lever arms applied in meters) is ignored.

JAE JM7531 MRU

HYSWEEP driver for the Japan Aviation Electronics motion sensor. Provides heave, pitch, roll, and heading data.

Connection:

RS232 Serial interface, binary message format.

Offsets – MRU (Pitch/Roll):

- **Starboard:** MRU location starboard of **boat center**.
- **Forward:** MRU location forward of **boat center**.
- **Vertical:** MRU location relative to waterline (positive below).
- **Yaw, Pitch, Roll:** MRU rotations relative to forward and vertical.
- **Latency:** Usually 0 for pitch and roll devices.

Offsets – Gyro (Heading)

- **Starboard, Forward, Vertical:** Enter 0.
- **Yaw:** Enter offset if any.
- **Pitch, Roll:** Enter 0.
- **Latency:** Usually 0 for heading devices.

Notes:

Klein HydroChart 3500

The Klein HydroChart 3500 is an interferometric side scan. It provides bathymetry, side scan, heading, pitch, and roll over a network stream. The driver communicates with the towfish through proprietary DLLs from Klein. The raw bathymetry is run through a processor DLL provided by Klein, then through the HYPACK Interferometry processing chain (see Appendix C).

Connection:

Via a TCP/IP network interface. The towfish IP address should be entered in HYSWEEP HARDWARE. Network port is ignored since the driver uses the Klein DLL for communication.

Setup:

Each system has a custom calibration file provided by Klein. It is recommended that this file be copied into the HYPACK BathyParms folder. This file should be selected on the setup form.

If the system includes an MRU, select the message being reported. This data is sent to HYPACK via the SDFX extension area.

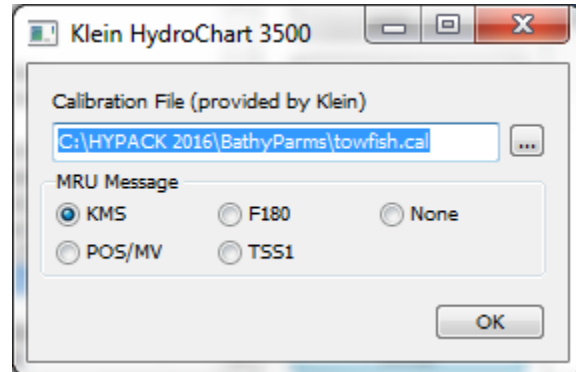

Notes:

- Uses KleinSDK 12.1
- The HydroChart reports page types: 3501, 3502, & 3503
- 3503 pages are processed through KleinDspEx library to generate 3511 pages

The latest Klein DLL files for bathy products should be copied into the HYPACK root folder along with the "BathyParms" folder provided by Klein. This folder contains configuration information needed by the Klein DLLs. The complete file listing relative to the HYPACK root folder is as follows:

BathyParms\ V1\ bathyparms.cal V2\ bathyparms.cal towfishHC3500.cal	ippi-6.0.dll ippip8-6.0.dll ippipx-6.0.dll ippis8-6.0.dll ippit7-6.0.dll ippiv8-6.0.dll ippiw7-6.0.dll ipps-6.0.dll ippsp8-6.0.dll ippspx-6.0.dll ipps8-6.0.dll ippst7-6.0.dll ippsv8-6.0.dll ippsw7-6.0.dll ippvm-6.0.dll	ippvmp8-6.0.dll ippvmpx-6.0.dll ippvms8-6.0.dll ippvmt7-6.0.dll ippvmv8-6.0.dll ippvmw7-6.0.dll KleinDspEx.dll KleinSonar.dll libguide40.dll libiomp5md.dll mfc100.dll mfc100enu.dll mfc100u.dll msvcp100.dll msvcr100.dll
--	--	--

Klein 5000

The Klein 5000 has several variations—the V1, V2, and HydroChart 5000. The sonar can be side scan only or can have bathy capabilities. See Sidescan Interfacing Notes for the side scan specific information. This section focuses on interfacing the Klein 5000 in HYSWEEP. The bathy support is similar to the HydroChart 3500; review that section for more details regarding the DLLs provided to HYPACK by Klein.

Connection:

Via a TCP/IP through a proprietary Klein DLL interface. Enter the towfish IP in HARDWARE. Network port is ignored (because it is handled by the DLL).

Setup:

The setup form details are the same as the HydroChart 3500.

Notes:

- Uses KleinSDK 12.1
- Reports page types: 5000, 5001, or 5004
- Raw 5001 and 5004 pages are processed through KleinDspEx to produce 5002 and 5004 with new processed channels respectively

Kongsberg KMALL

Support for EM 2040, EM 712 and EM 304 multibeam sonar systems using the KMALL datagram set. The driver interfaces with Kongsberg K-Control directly or through Kongsberg SIS 5 software. With HYPACK and K-Control / SIS 5 on the same or different computers.

Interfacing is quite complicated. Refer to Appendix E for complete instructions or use the following Sounding Better link:

https://www.hypack.com/File%20Library/Resource%20Library/Technical%20Notes/10_2022/Ken-Aiken---Logging-in-HYSWEEP-with-EM2040-Firmware-5-and-KMALL.pdf

Kongsberg EM3000

HYSWEEP driver for the Kongsberg EM3000 multibeam sonar. Provides pitch and roll corrected multibeam soundings along with HPR and heading data.

Connection:

All data is via a network interface. In HYSWEEP hardware, use default Internet Address (127.0.0.1) and Port number to match that set in the EM3000 (2060 in one installation). In windows Network properties, the HYPACK PC must be set to the IP address used by the EM3000. Settings at the Port of Valencia are shown below.

Offsets - MRU:

- **Starboard:** MRU location starboard of **boat center**.
- **Forward:** MRU location forward of **boat center**.
- **Vertical:** MRU location relative to waterline (positive below).
- **Yaw, Pitch, Roll:** Enter 0 (see notes).
- **Latency:** Enter 0.

Offsets - Gyro:

- **Starboard, Forward, Vertical:** Enter 0.
- **Yaw:** Typically 0.
- **Pitch, Roll, Latency:** Enter 0.

Offsets – Sonar Heads 1 and 2:

- **Starboard:** Sonar head locations starboard of **boat center**.
- **Forward:** Sonar head locations forward of **boat center**.
- **Vertical:** Sonar head locations relative to waterline (positive).
- **Yaw, Pitch, Roll:** Sonar head rotations - enter values determined by patch testing (see notes)
- **Latency:** Enter 0.

Notes:

- HYSWEEP survey requires 3 datagrams from the EM3000: Attitude (A=41), Depth (D=44) and Raw Range and Beam Angles (F=46). (A) gives heave, pitch, roll and heading, (D) is only used for the sonar sampling rate and (F) is the raw sonar data.

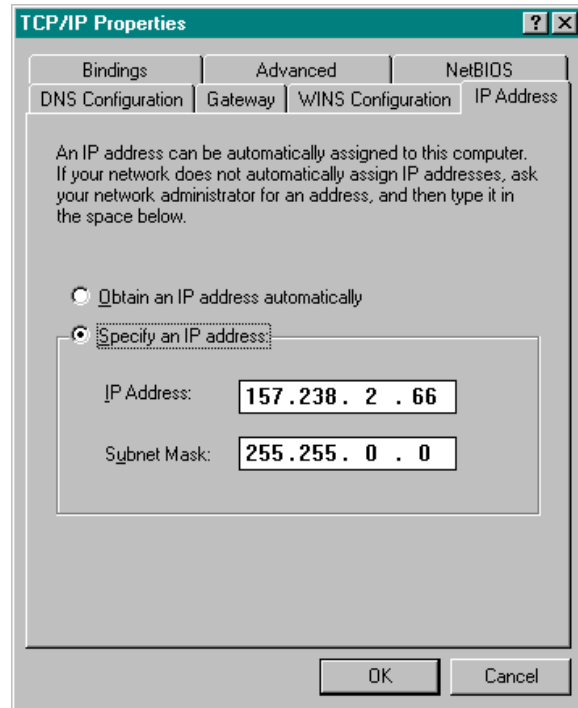

- EM3000 calibration offsets are entered under MRU pitch/roll/heading. DO NOT enter these values in HYSWEEP hardware as we subtract MRU pitch/roll offsets and Kongsberg adds them. Instead, add them to EM3000 sonar installation offsets and enter in HYSWEEP hardware under sonar yaw/pitch/roll. It is better to ignore the Kongsberg angles and do the calibrations in HYSWEEP patch test.
- The EM3000 comes in single and dual head models. Enter offsets accordingly.
- Both the HYPACK/HYSWEEP computer and the EM3000 must be time synchronized to UTC time (\$GPZDA message) for data times to match up.

Kongsberg EM1002, EM2000, EM2040, EM3002/D, EM302, EM710

HYSWEEP driver for Kongsberg multibeam sonar models. Can provide raw or corrected multibeam soundings along with HPR and heading data. Select raw or processed mode on the setup form.

If using processed data: sound velocity corrections are made before transfer from EM to HYSWEEP, so different SV profile cannot be used in post-processing. In addition to sound velocity, calibration and sensor offsets are entered in SIS (EM control program) and should not be repeated in HYSWEEP hardware.

If using raw data: all offsets, SVP, and other corrections need to be entered into HYSWEEP Hardware. (Don't forget the mounting angle for each transducer on dual head sonars.)

Kongsberg Setup

EM Data Selection

- Use Seabed Image (53) Datagram for Sidescan Display
- Use EM Combined Heave/Draft from Depth (D or X) Datagram
- Reverse Raw Beam Angles

EM3000

- Use Raw Data
- Use Processed Data

Default Setup OK Cancel

Setup Form:

Use Seabed Image (53) Datagram for Sidescan Display: When this option is selected, the Seabed Image datagram is converted to digital sidescan, which is logged and shown in the HYSWEEP waterfall display.

Use EM Combined Heave/Draft from Depth (D or X) Datagram: When this option is selected, depths are corrected with the combined heave & draft field from the EM depth (D or X) datagrams. When not selected, the heave from the Attitude datagram (A) and the draft from HYSWEEP Hardware setup are applied. *We recommend this option be checked.* That way all sonar offsets are entered in SIS and there is less possibility of confusion.

Reverse Raw Beam Angles: Use this for reversed EM3000 and EM2040 mounting.

Connection:

For KMALL use network port 6020.

All data is via a network interface. In HYSWEEP hardware, use default Internet Address (127.0.0.1) and Port number to match that set in SIS (16103 at Port of St. John). SIS should be configured to output the following datagrams to HYSWEEP: Attitude (A), Depth (D or X) and Sound Speed profile (U). To view backscatter data, use the Seabed Image (S) datagram. If using raw data, enable Installation (I) and the relevant raw message, such as Raw Range & Angle 78 (N).

When SIS is run on a remote computer from HYSWEEP, a Kongsberg program 'Datadistrib.exe' must be run to transfer datagrams over the Ethernet connection. Datadistrib.exe requires the Internet Address of the HYSWEEP PC and a port selection (for example, I.P 157.237.60.30, Port 5000). In this case, the port number in HYSWEEP hardware is set to match Datadistrib.exe.

Datagram	IP:Port	Interval
Information	localhost:9004	All
Information	localhost:4002	All
Motion sensor	localhost:4002	All
Clock	localhost:4002	All
Depth	localhost:4002	All
Installation	localhost:9004	All
Position	localhost:16108	All
Position	localhost:9004	All
Position	localhost:9009	All
Position	localhost:4002	All
Position	HDP:5052	All
Runtime	localhost:4002	All
XYZ88	localhost:4002	All
Height	localhost:4002	All
Watercolumn	localhost:16102	All
Motion sensor	192.168.0.85:5000	All
Sound speed profile	192.168.0.85:5000	All
XYZ88	192.168.0.85:5000	All
SeabedImageData89	192.168.0.85:5000	All
Depth	192.168.0.85:5000	All
Seabed image	192.168.0.85:5000	All
Position	192.168.0.87:16103	All
Sound speed profile	192.168.0.87:16103	All
Seabed image	192.168.0.87:16103	All
Installation	192.168.0.87:16103	All
Raw range and angle 78	192.168.0.87:16103	All

Offsets:

In general, all system offsets are entered in SIS and should not be repeated in HYSWEEP hardware. I.e., leave the offsets = 0. The exception:

- When "Use EM Combined Heave/Draft from Depth Datagram" is not selected. In that case, the draft of the sonar head is entered as a vertical offset.

Notes:

- Both the HYPACK/HYSWEEP computer and the EM system must be time synchronized to UTC time (\$GPZDA message or 1PPS) for data times to match up.
- Repeat: You can not apply a sound velocity profile in post processing.
- When viewing Seabed Image in HYSWEEP under the Sidescan Waterfall display, the range must be set manually. Use Sidescan Controls, Display tab to enter range.

Kongsberg ME70

HYSWEEP driver for the Kongsberg ME70 sonar.

Connection:

A network (UDP) interface. The driver communicates with the ME70 terminal software. In **HARDWARE**, set the IP Address in the driver setup to the address of the terminal computer. The port field is not used.

The ME70 has a complicated initialization process. On startup, the driver sends an "RSI" command on port 37655 to request a command connection. The driver is then assigned a command port by the ME70. A second port for data is then opened on port 1502.

Beamforming is handled in the driver. The control form allows you to toggle multi-detect and detection gates.

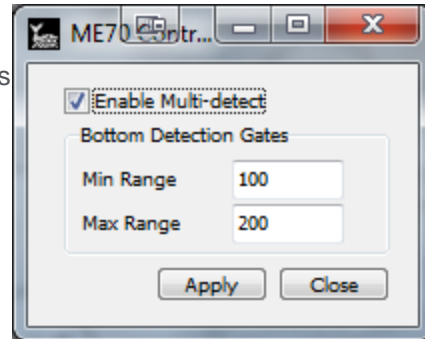

Offsets:

- **Starboard:** Sonar head locations starboard of **boat center**.
- **Forward:** Sonar head locations forward of **boat center**.
- **Vertical:** Sonar head locations relative to waterline (positive).
- **Yaw, Pitch, Roll:** Sonar head rotations - enter values determined by patch testing.
- **Latency:** Enter 0.

Notes:

Kongsberg SM2000

HYSWEEP driver for the Kongsberg SM2000 multibeam sonar.

Connection:

RS232 Serial interface, binary message.

Offsets:

- **Starboard:** Sonar head locations starboard of **boat center**.
- **Forward:** Sonar head locations forward of **boat center**.
- **Vertical:** Sonar head locations relative to waterline (positive).
- **Yaw, Pitch, Roll:** Sonar head rotations - enter values determined by patch testing.
- **Latency:** Enter 0.

Notes:

Kongsberg MS 1000 Profiler

The MS 1000 profiler is supported in horizontal mount mode, used as a conventional multibeam. This driver does not support multiple profilers or sidescan modes. For these modes, there is a custom HYPACK driver which is beyond the scope of this document. The driver will also read heading if provided.

Connection:

Via a TCP/IP network interface to the MS 1000 software which can be on the same or different computer as HYPACK. Default port 5000.

Notes:

- The driver will record the detect sample from the imagery information as beam intensity.
- A complete sector is logged as a single ping
- Angles which imply an inverted mount (ie 90 to 270) are rotated 180 degrees

KVH Gyrotrac

Driver for KVH Gyrotrac – heading, pitch and roll device.

Setup Form:

No specific setup for this driver.

Connection:

RS232 Serial interface. An example message is shown below:

```
%pp,rr,hhh<cr><lf>  
pp is the pitch x 10,  
rr is the roll x 10  
hhh is heading x 10
```

Offsets:

- **Starboard, Forward, Vertical:** Mounting offsets from boat center / waterline.
- **Yaw:** Enter the heading correction if any.
- **Pitch, Roll:** Enter the pitch and roll corrections if any.
- **Latency:** Enter the device latency time if any - positive, seconds.

Notes:

Leica P20/P15/P30/P16, P40, P50

These LiDAR devices from Leica scan vertically. With HYPACK, the devices do not rotate horizontally while collecting data.

Connection:

Network interface through a proprietary DLL that is distributed with HYPACK.

Enter the serial number of the device as the Internet Address. The default port is 10002.

Setup Form:

Choose the EDM Mode and Scan Mode options available for the selected Leica model.

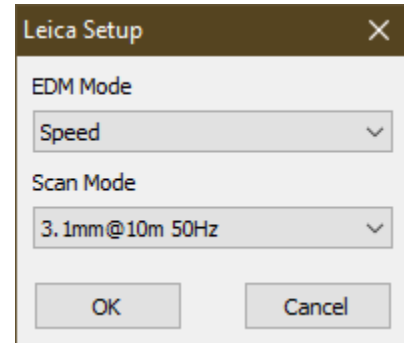

Offsets:

- **Starboard, Forward, Vertical:** Mounting offsets from boat center / waterline.
- **Yaw:** Enter the heading correction if any.
- **Pitch, Roll:** Enter the pitch and roll corrections if any.
- **Latency:** Enter the device latency time if any - positive, seconds.

Control Form:

The Leica Control form allows filtering of the range and angles of collected data.

Range is in the units of the project geodesy (feet/meters).

Angle is in degrees, starting from -55 and going to 235. It is treated as elevation angle, where 0 degrees is the horizon and 90 degrees is the zenith, straight into the sky. The green portion of the diagram is the area where data will be collected. The red portion is where data will be ignored.

The status bar at the bottom of the form updates once per second with the latest information regarding PPS sync with the device.

Notes:

The device *must* use the PPS sync wiring per the Leica manuals in order to have valid timestamping. If this is not present, the driver will fall back to Veritime timing, but this will be less accurate and is not recommended.

There is a chance at higher resolutions HYSWEEP will not collect all data from this device. A "Too much data!" message will be displayed in the messages window once every 5 seconds or so. You will still obtain data at the chosen resolution, but there may be gaps in your coverage along the line you are traveling. If you want to remove gaps along the line, try a lower resolution.

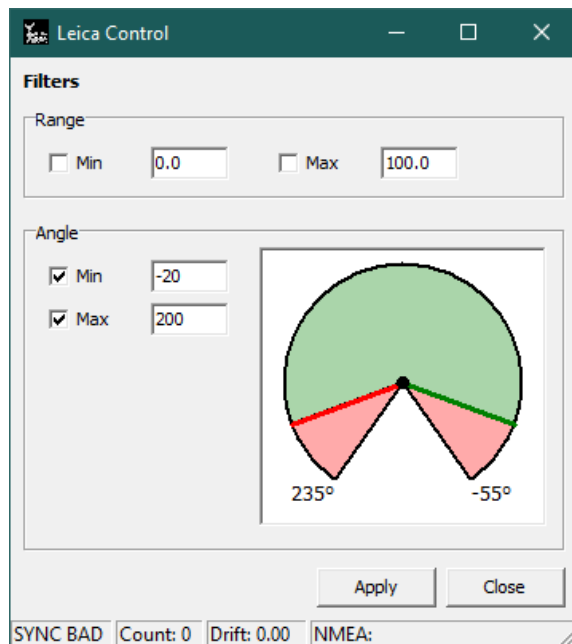

MDL Dynascan laser

MDL was purchased by Renishaw which sold this product line to Carlson Software. See the Carlson Merlin section.

NMEA Gyro

Driver for gyros, compasses or other heading devices (e.g., GPS antenna arrays) that output the NMEA-0183 “HDT” or “HDM” heading sentence.

Connection:

RS232 Serial interface. An example message is shown below:

```
$HDHDT,079.3,T
```

Offsets:

- **Starboard, Forward, Vertical:** Not used – set to 0.
- **Yaw:** Enter the heading correction if any.
- **Pitch, Roll:** Not used – set to 0.
- **Latency:** Enter the gyro latency time if any - positive, seconds.

Notes:

NORBIT Dual Head

Dual head driver for NORBIT WBMS (below)

Setup Form:

WBMS Setup

Sidescan Recording

Snippet SS Recording

Use Pass Through Position, Heading and MRU

Use Rotator Data

Send Start / Stop Logging Commands

Snippet Recording

Log Datagrams

Log Water Column

Dual Head

Port: 7001

Log Head 1,2 Snippet Datagrams to Separate Files

Merge Head 1,2 Snippet Datagrams into a Single File

OK Cancel

- **Sidescan Recording:** Check this to enable side scan data.
- **Snippet SS Recording:** Check this to enable alternate side scan data from sonar.
- **Snippet Recording:** Log data for snippet image processing.
- **Log Seabat Datagrams:** Use this to log raw network datagrams to *.7K files. This is done automatically if snippets are enabled.
- **Log Water Column:** Check this to display and log water column data.
- **Send Start/Stop Logging Commands:** When enabled, start/stop logging messages are sent from HYSWEEP® Survey to the NORBIT device.
- **Port:** Use this field to change the secondary head port value.

Pass through data is not available for dual head in HYPACK 2021.

Connection:

Default Network Ports: Primary head = 7000, Secondary head = 7001.

Internet address = 127.0.0.1.

To change the primary port value, in the HYPACK Combined Hardware window, click the Connect tab and enter the new port number under Network Connection.

To change the secondary port value, double click on NORBIT Dual Head to open the WBMS Setup window, then enter the new port number under the Dual Head section.

Offsets:

Two sets of offsets. One per head.

- **Starboard:** Sonar head location starboard of **boat center**.
- **Forward:** Sonar head location forward of **boat center**.
- **Vertical:** Sonar head location relative to waterline (positive down).
- **Yaw, Pitch, Roll:** Patch test offsets.
- **Latency:** Enter 0 – latency is automatically compensated.

NORBIT WBMS

Multibeam, side scan, snippet and water column using Teledyne-Reson 7K data format.

Setup Form:

WBMS Setup

Sidescan Recording

Snippet Recording

Snippet SS Recording

Log Datagrams

Use Pass Through Position, Heading and MRU

Use Rotator Data

Log Water Column

Send Start / Stop Logging Commands

Dual Head

Port: 7001

Log Head 1,2 Snippet Datagrams to Separate Files

Merge Head 1,2 Snippet Datagrams into a Single File

OK Cancel

- **Sidescan Recording:** Check this to enable side scan data.
- **Snippet SS Recording:** Check this to enable alternate side scan data from sonar.
- **Snippet Recording:** Log data for snippet image processing.
- **Log Datagrams:** Use this to log raw network datagrams to *.7K files. This is done automatically if snippets are enabled.
- **Use Pass Through Position, Heading and MRU:** Takes data from 7K datagrams. Heading and MRU are logged directly to HSX. Position can be used for HYPACK survey navigation. See Appendix D for navigation setup.
- **Use Rotator Data:** Takes pan and tilt from 7K datagrams. Used for rotating head configuration.
- **Log Water Column:** Check this to display and log water column data.
- **Send Start/Stop Logging Commands:** When enabled, start/stop logging messages are sent from HYSWEEP® Survey to the NORBIT device.

Connection:

Default Network Port: Primary head = 7000.

Internet address = 127.0.0.1.

To change the primary port value for the NORBIT Dual Head, in the HYPACK Combined Hardware window, click the Connect tab and enter the new port number under Network Connection.

Offsets:

- **Starboard:** Sonar head location starboard of **boat center**.
- **Forward:** Sonar head location forward of **boat center**.
- **Vertical:** Sonar head location relative to waterline (positive down).
- **Yaw, Pitch, Roll:** Patch test offsets.
- **Latency:** Enter 0 – latency is automatically compensated.

Novatel SPAN

Driver for Novatel SPAN-SE motion sensor and gyro. Reads timestamped heading, heave, pitch, & roll from a network stream.

Connection:

The device can be configured in many different ways. HYSWEEP expects a TCP network connection. The device's default IP address and port are 192.168.0.10, port 3000. To configure the device, a series of commands need to be sent to it using the Novatel CDU software. They are:

```
LOG ICOM2 BESTPOSA ONTIME 0.2
LOG ICOM2 HEAVEA ONNEW
LOG ICOM2 INSPVAA ONTIME 0.05
LOG ICOM2 TIMEA ONTIME 1
LOG ICOM3 INSPVAA ONTIME 0.05
LOG ICOM3 HEAVEA ONNEW
LOG ICOM3 TIMEA ONTIME 1
SAVECONFIG
```

"IPCONFIG" sets the network address. The remaining lines configure which outputs to HYPACK and HYSWEEP are enabled. The "ICOM3" lines turn on the messages HYSWEEP expects to see:

- INSPVAA - pitch, roll, heading
- HEAVEA - heave
- TIMEA - GPS time to UTC time offset

Note: TIMEA is critical for correct timetags!

Offsets:

- **Starboard, Forward, Vertical:** Not used – set to 0.
- **Yaw:** Enter the heading correction if any.
- **Pitch, Roll:** Not used – set to 0.
- **Latency:** Enter the gyro latency time if any - positive, seconds.

Notes:

- Based on the commands described above, Port 3001 (ICOM2) should be entered in HYPACK Hardware and Port 3002 (ICOM3) should be entered in HYSWEEP Hardware.

Odom Echoscan II

Driver for the Odom Echoscan II multibeam and sidescan sonar.

Setup Form:

Select the analog sidescan .

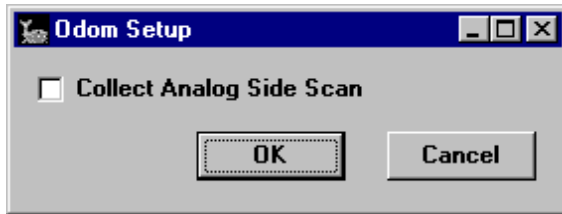

Connection:

RS232 Serial interface, binary message

Offsets – Sonar Head

- **Starboard:** Sonar head location starboard of **boat center**.
- **Forward:** Sonar head location forward of **boat center**.
- **Vertical:** Sonar head location relative to waterline (positive).
- **Yaw, Pitch, Roll:** Sonar head rotations relative to forward and vertical. Enter values determined by patch testing.
- **Latency:** Enter 0 – latency is automatically compensated.

Notes:

- When using the analog sidescan a separate program is run automatically. Ascan.exe samples the sidescan channels and passes data to HYSWEEP Survey through shared memory. See "Analog Sidescan" device above for configuration info. The screen shot shows analog setup for the Echoscan.

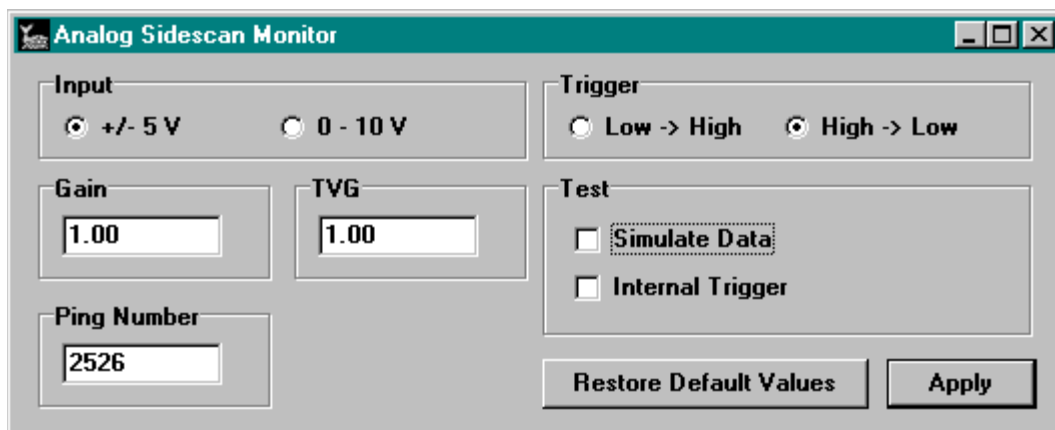

Odom ES3

Driver for the Odom ES3 multibeam. See Imagenex Delta-T.

Odom ES3 – Dual Head

Driver for the Odom ES3 dual head multibeam. See Imagenex Delta-T – dual head.

Odom MB1

Driver for the Odom MB1 multibeam system. 120 degree system.

Setup Form:

- **Use RTA Interface** – Normally checked on. Receive motion and heading corrections via the Real Time Appliance interface. With this option, all time tagging is done outside HYPACK and HYSWEEP survey.
- **Log Snippets** – Check this box to log raw data to a *.MB1 file. The MB1 file is used for snippet post processing.
- **Max Beams Used (Per Head)** – Number of beams logged by HYSWEEP survey. Normally 240, although the MB1 is capable of 512 beams.

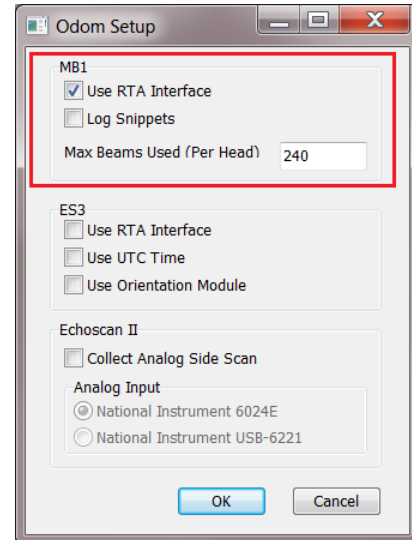

Connection:

Network interface using UDP datagrams. In testing on the Odom boat, the HYPACK computer IP address was set at 192.168.1.4.

- **Port** – Default is 56002.
- **Internet address** – 127.0.0.1 or address of the MB1 top side unit.

Network Test:

- **UDP Connect** – Click to view the unparsed network messages.

Offsets:

- **Sonar Head 1** – Enter location and patch test offsets. Latency should be 0.
- **MRU Offsets** – MRU offsets should be entered when using the RTA interface.
- **Heading Offset (Yaw)** – Enter when using the RTA interface.

Setup in HYPACK Hardware

When using the RTA interface, setup the GPS.DLL driver as shown.

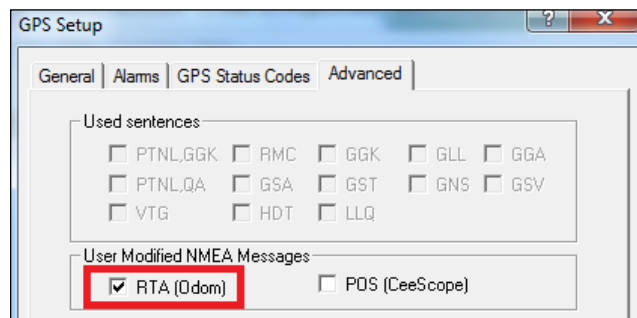
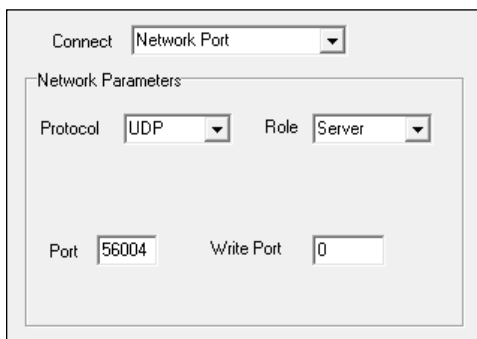

Odom MB1 – Dual Head

Driver for the Odom dual head MB1. With 30 degree rotation of each head, the system provides + / - 180 degree coverage with 30 degree overlap at nadir.

Setup Form:

- **Use RTA Interface** – Normally checked on. Receive motion and heading corrections via the Real Time Appliance interface. With this option, all time tagging is done outside HYPACK and HYSWEEP survey.
- **Log Snippets** – Snippets are not supported by the dual head driver.
- **Max Beams Used (Per Head)** – Number of beams logged by HYSWEEP survey. Normally 240 beams per head = 480 beams total.

Connection:

Network interface using UDP datagrams. In testing on the Teledyne boat “Bottom Line”, the HYPACK computer IP address was set at 192.168.1.4.

- **Port** – Default is 56002.
- **Internet address** – 127.0.0.1 or address of the master MB1 top side unit.

Network Test:

- **UDP Connect** – Click to view the unparsed network messages.

Offsets:

- **Sonar Heads 1 and 2** – Enter location and patch test offsets. Latency should be 0.
- **MRU Offsets** – MRU offsets should be entered when using the RTA interface.
- **Heading Offset (Yaw)** – Enter when using the RTA interface.

Setup in HYPACK Hardware

See Odom MB1 setup.

Notes:

- The driver will not collect data unless both heads are pinging.
- The driver works properly in both MB1 ping modes; Alternate and Simultaneous.
- Ping rate (each head) should be limited to 20 times per second. This limitation allows the driver to accommodate Windows networking delays.

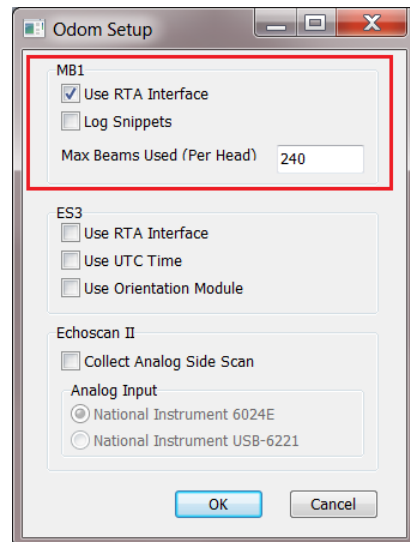

Odom Miniscan

Driver for the Odom Miniscan multiple transducer system.

Setup Form:

No specific setup for this driver.

Connection:

RS232 Serial interface. An example message is shown below:

```
$ F 45.10 45.20 45.00 43.40 43.50 43.60 44.70 45.80
```

Offsets – Transducers 1 through 8:

- **Starboard:** Transducer position starboard of **boat center**.
- **Forward:** Transducer position forward of **boat center**.
- **Vertical:** Transducer draft (positive).
- **Yaw, Pitch, Roll:** All zeros.
- **Latency:** Enter the latency time (positive, seconds) appropriate for each transducer.

Notes:

Optech ILRIS 3D

Driver for the Optech ILRIS 3D laser scanner. HYSWEEP supports operating in line scan mode only and expects the scan task to be appropriately configured as such in the ILRIS controller software.

Setup Form:

In HYPACK 2014 and earlier, the port/starboard mounting and beam downsampling were configurable on the setup form. In 2014b and later, the port/starboard mounting is configured by setting the Yaw offset to +/- 90 as necessary.

During survey, check the "Use TOP Message" Logging Option to log full resolution data. If this option is turned off, HYSWEEP will automatically downsample to 1440 beams per line scan.

If Optech timestamps are desired, you must insure that the laser is timesynched with HYSWEEP. The typical method is to split the GPS PPS pulse and sync both devices using it.

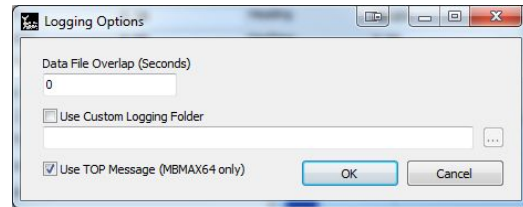

Offsets:

In addition to any mounting offsets, the ILRIS requires the following offsets to translation from the measurement center to the bolt hole of the device: X = 0, Y = -24.53mm, Z = -191.79mm where:

+X is through the right side, when looking at the back

+Y is through the front, from where the system scans

+Z is straight up through the top

Note that X & Y will need to be swapped and/or inverted relative to the boat depending on if the device is mounted pointing off port or starboard.

Connection:

Via a TCP/IP network interface to the ILRIS controller software provided by Optech. It can run on the same, or a different, computer as HYPACK. In HYSWEEP Hardware, the IP address is that of the controller's computer; the default port is 2000. Make sure data streaming is turned on with the controller's View->Data Streaming menu option. Leave decimation off unless you have reason otherwise.

Notes:

Pictured on the right is an example configuration of a continuous vertical line scan in the ILRIS Controller.

Adjusting the spacing option will alter the resolution, but remember: HYSWEEP cannot take more than 1440 points per line. Resolution that is too high will cause the scanner to return fewer lines per second and all the extra points will be thrown away anyway.

For optimum data density, adjust the spacing to return close to the same number of beams set in HYSWEEP Hardware. What you "sacrifice" in resolution you make up for in more pings per second., which could actually give you more **points** per second.

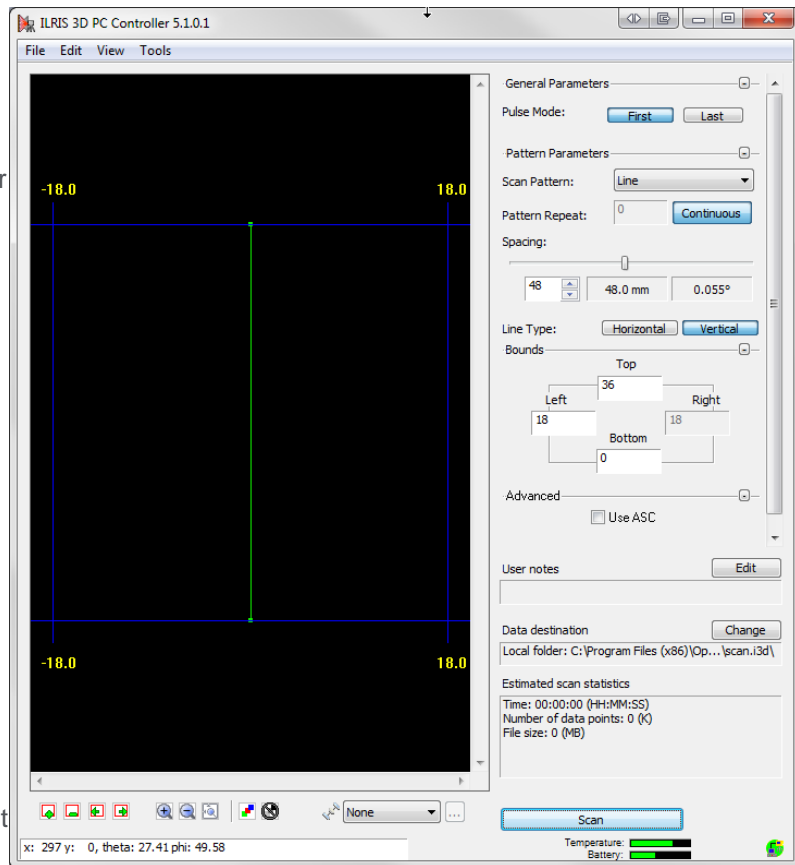

2014 and Earlier Setup Form:

The setup form provides several options:

1. The number of beams per line. Input will be decimated to fit and is subject to the HYSWEEP limit of 1440 beams per ping.
2. Specify if the laser is mounted to scan off the port or starboard side of the boat.
3. Optech can optionally provide timestamps. 'Use PC Time' will ignore their timestamps and use Veritime instead. If not provided, the driver defaults to Veritime.

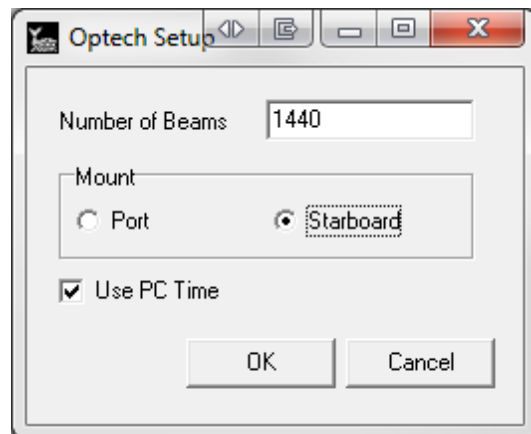

If Optech timestamps are desired, you must insure that the laser is timesynched with HYSWEEP. The typical method is to split the GPS PPS pulse and sync both devices using it.

Optech Polaris

Driver for the Optech Polaris laser system.

Setup Form:

- **Survey Directory:** The directory on the Polaris hard drive that raw data of the survey will be saved. The raw survey data on the Polaris hard drive is not compatible with HYPACK.
- **Auto Survey Name:** The Polaris will name the raw survey data automatically on its hard drive.
- **Survey Name:** If Auto Survey Name is not selected, use this to manually define the name of the raw survey data.
- **Return Selection:** Save the first return, last return, or all returns the device receives.
- **Scanner (Vertical FOV):** The picture represents the Polaris sitting upright with the top of the device pointed at the 90 degree line, and the scanner pointing to the right at the 0 degree line. The green sector in the picture represents the vertical field of view that will be scanned. Red sectors indicate portions of the vertical field of view that will NOT be scanned.

- **Start Angle:** The vertical angle the laser starts scanning from. This is represented by the green line in the picture.
- **Stop Angle:** The vertical angle the laser scans to. This is represented by the red line in the picture.
- **Rate (Hz):** The number of times that the vertical field of view is scanned each second.
- **Pan (Horizontal FOV):** The picture represents looking down at the top of the Polaris, with the scanner pointed at the 0 degree line. The green sector in the picture represents the horizontal field of view that will be scanned. The red sector indicate portions of the horizontal field of view that will NOT be scanned.
 - **Start Angle:** The horizontal angle the laser starts panning from. This is represented by the green line in the picture.
 - **Stop Angle:** The horizontal angle the laser pans to before reversing its rotation. This is represented by the red line in the picture. The Polaris will pan back to the start angle and reverse its rotation again at that point.
 - **Speed (°/sec):** The number of degrees that the Polaris pans each second.
- **Laser PRF (kHz):** The Pulse Repetition Frequency of the laser. Use 500 kHz for ranges up to 250 m. Use 200 kHz for ranges up to 750 m. Use 50 kHz for long distance ranges up to ~2000 m.
- **CPU Usage (%):** This determines the percentage of CPU threads used to process the raw point data from the Polaris. You will need to experiment with this value based on your survey computer specifications and Polaris settings. Lower values may lose points during collection. Higher values may inhibit HYSWEEP from collecting data from all devices properly.

Offsets:

The x and y offsets for the Polaris should be measured at the center of the device. The z (vertical) offset is measured at the starburst marks on the sides of the housing. When measuring your x and y offsets, you can measure to one of the starburst marks on the device and add the radius (123.3 mm) to your measurement.

If using the mobile mount provided by Optech, the mount has a hole on the bottom plate located at the X, Y center of the Polaris. The vertical offset with the mobile mount is 347mm.

Connection:

Ethernet connection from Polaris to survey computer. The IP address of the device is 192.168.0.1 and the port is 5000. This is the default value in the HYPACK hardware settings when you add the driver and should never need to be changed. Make sure your network adapter IP address is 192.168.0.x where x is a value that isn't 1.

The Polaris needs an external PPS/NMEA source connected to it to get accurate timing in HYPACK. Without an external source, the time tags will start from 0 and be invalid.

Notes:

All numerical settings in the Setup Form are bounds checked and error checked. This means if you type an invalid setting, when you move to another setting or hit OK, that value will change automatically to a valid setting.

Most numbers in the Setup Form can be entered as non-integer numbers, like 2.5 or 12.78. All decimals are rounded to two decimal places.

The recorded data will not be timetagged properly without an external PPS/NMEA source. You must have an external PPS/NMEA source or timetags will be invalid.

Ouster OS-1

Driver for the Ouster OS-1 line of laser devices. This driver is for the first generation of firmware, not the recently updated 2.0 firmware.

Setup Form:

- **Time source – GPS:** GPS requires a connection to the Ouster Interface box using the sync_pulse_in and multipurpose_io pins with the PPS signal and the NMEA UART output of the GPS respectively. The Ouster expects a \$GPRMC string. The GPS voltage requirements are 3.3 - 15 V with a minimum drive current of 5 mA. Using this option allows you to change the settings in the GPS section of the Setup Form.
- **Time source – PTP:** If you have a PTP master clock device, connect the Ouster to the same network as the PTP device and use this option.
- **Time source – Internal:** This will return the time since device startup. This option enables the Sync to HYPACK checkbox. With Sync to HYPACK, the internal time is converted to the time HYPACK thinks it is when data is received. The timing gap is reset once a gap of two standard deviations is reached between the Ouster time and HYPACK time. This is the least accurate method of timing.
- **GPS – NMEA Polarity:** Set the expected polarity of the incoming NMEA signal.
- **GPS – PPS Polarity:** Set the expected polarity of the incoming PPS signal.
- **GPS – Baud Rate:** Set the baud rate of the incoming NMEA signal
- **Mode – Resolution:** The number of times the device collects points each rotation (horizontal resolution). Each time the device collects points it collects each vertical channel (vertical resolution). Total points collected each rotation is horizontal resolution times vertical resolution.
- **Mode – Frequency:** The number of times the scanner rotates per second. With 2048 as resolution, frequency is limited to 10 Hz. Total points collected per second is horizontal resolution times vertical resolution times frequency.
- **IP Address (PC):** This is the IP address of the computer running HYPACK on the network that the Ouster is connected to. This tells the Ouster which device to send the point data to.

Ouster Setup

Time source

GPS PTP Internal

Sync to HYPACK

GPS

NMEA Polarity: High Low

Baud Rate: 9600 115200

PPS Polarity: High Low

Mode

Resolution: 512 1024 2048

Frequency: 10 Hz 20 Hz

IP Address (PC):

OK Cancel

Offsets:

The x and y offsets should be measured to the center of the device. For the OS-1 line of Ouster devices, the z offset from the base of the device is 36.180 mm.

Connection:

UDP over gigabit ethernet connection from Ouster to survey computer. HYPACK requires that the Ouster be configured with a static IP address or the link-local address. Follow the Ouster instruction manual to set one of these up properly. The ports are hard coded as 7501, 7502, and 7503.

Control Form:

The incoming point cloud can be thinned in real-time during survey with the filters provided on the HYSWEEP Ouster controller. Note that these filters are on the HYPACK side and no commands are sent to the device. Points filtered by this method are lost--they are not displayed or logged.

Notes:

For the most accurate data, we recommend using an external GPS or PTP device instead of the internal clock.

Filters

Range

Min 0

Max 0

Angle

Min 0

Max 0

Enabled Beams Check All Check None

<input checked="" type="checkbox"/> 1	<input checked="" type="checkbox"/> 9	<input checked="" type="checkbox"/> 17	<input checked="" type="checkbox"/> 25
<input checked="" type="checkbox"/> 2	<input checked="" type="checkbox"/> 10	<input checked="" type="checkbox"/> 18	<input checked="" type="checkbox"/> 26
<input checked="" type="checkbox"/> 3	<input checked="" type="checkbox"/> 11	<input checked="" type="checkbox"/> 19	<input checked="" type="checkbox"/> 27
<input checked="" type="checkbox"/> 4	<input checked="" type="checkbox"/> 12	<input checked="" type="checkbox"/> 20	<input checked="" type="checkbox"/> 28
<input checked="" type="checkbox"/> 5	<input checked="" type="checkbox"/> 13	<input checked="" type="checkbox"/> 21	<input checked="" type="checkbox"/> 29
<input checked="" type="checkbox"/> 6	<input checked="" type="checkbox"/> 14	<input checked="" type="checkbox"/> 22	<input checked="" type="checkbox"/> 30
<input checked="" type="checkbox"/> 7	<input checked="" type="checkbox"/> 15	<input checked="" type="checkbox"/> 23	<input checked="" type="checkbox"/> 31
<input checked="" type="checkbox"/> 8	<input checked="" type="checkbox"/> 16	<input checked="" type="checkbox"/> 24	<input checked="" type="checkbox"/> 32

Apply Close

Picotech PicoMBES

The Picotech PicoMBES is a range/angle echosounder with 40° and 120° models.

Connection:

UDP network connection. The sonar expects the HYPACK computer to have address 10.0.100.70 and to receive data on port 13000. The MBES is 10.0.100.120 and sends data from port 9000. The MBES port and address is what should be entered in HYPACK HARDWARE.

Setup:

No setup form.

Notes:

- As of May 2016 the IP addresses are not configurable on the Picotech side. This may change in the future
- GPS & PPS should be wired into the PicoMBES cabling to insure valid timetagging

Controller:

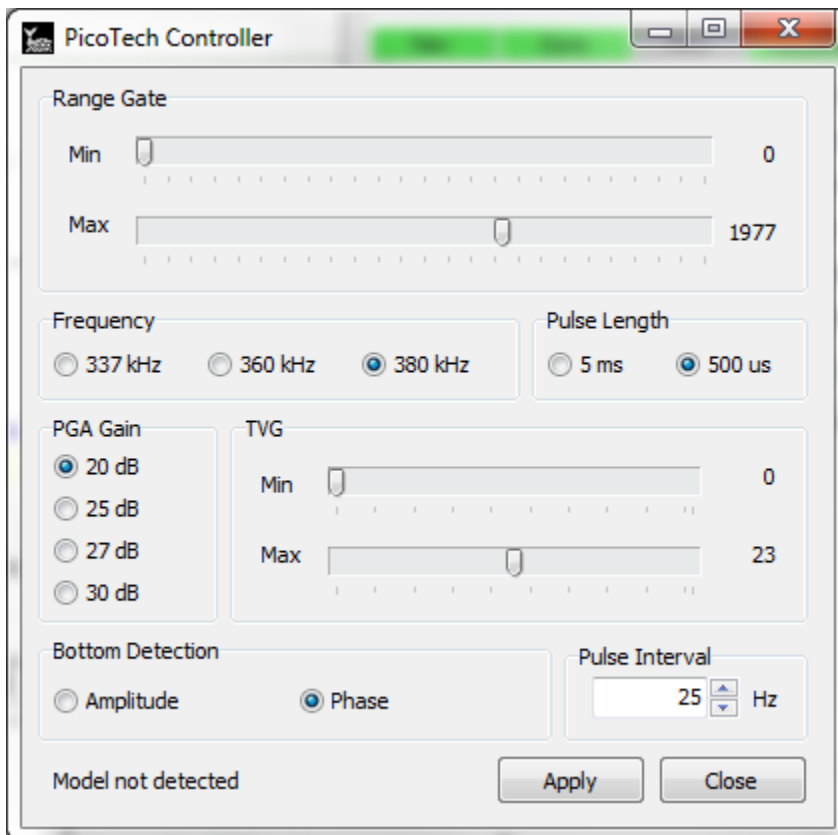

The screenshot shows the PicoTech Controller software interface. The window title is "PicoTech Controller". The interface includes several control panels:

- Range Gate:** Two sliders. The "Min" slider is at 0, and the "Max" slider is at 1977.
- Frequency:** Radio buttons for 337 kHz, 360 kHz, and 380 kHz (selected).
- Pulse Length:** Radio buttons for 5 ms and 500 us (selected).
- PGA Gain:** Radio buttons for 20 dB (selected), 25 dB, 27 dB, and 30 dB.
- TVG:** Two sliders. The "Min" slider is at 0, and the "Max" slider is at 23.
- Bottom Detection:** Radio buttons for Amplitude and Phase (selected).
- Pulse Interval:** A numeric input field set to 25 Hz.

At the bottom of the window, it says "Model not detected" and has "Apply" and "Close" buttons.

PingDSP 3DSS-DX

Driver for the PingDSP interferometer. It is a passive TCP/IP network driver which reads bathymetry, side scan, motion, and heading data.

Setup Form:

Configure the type of message being sent to HYPACK by the PingDSP controller here.

Connection:

Via a TCP/IP network interface to the controller software provided by PingDSP. Enter the IP address of the controller software on the Connect tab. The port is locked to the manufacturer default: 23848.

See Appendix C for details on real-time processing of interferometry data in HYSWEEP.

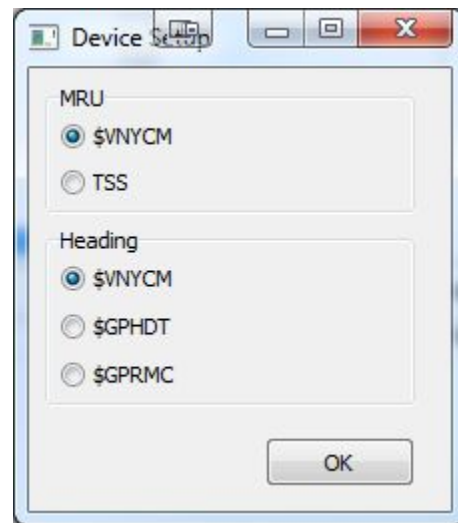

The image shows a screenshot of a software dialog box titled "Device Setup". The dialog has a standard Windows-style title bar with minimize, maximize, and close buttons. The main content area is divided into two sections: "MRU" and "Heading". Each section contains a list of radio button options. In the "MRU" section, the option "\$VNYCM" is selected. In the "Heading" section, the option "\$VNYCM" is also selected. Other options in the "Heading" section include "\$GPHDT" and "\$GPRMC". At the bottom right of the dialog, there is an "OK" button.

R2Sonic Dual Head 2020, 2024

HYSWEEP driver for R2Sonic sonar in dual head configuration. The driver merges data from two heads for logging and processing.

Setup Form:

- **Data Format:** Select R2Sonic format.
- **Local IP Address:** We pass this to the sonar processor so it knows where to send data. This is the IP address of the computer running HYPACK / HYSWEEP.
- **Log Snippet Data:** Ignored – dual head driver does not support snippets.
- **Log TruePix Data:** Enables HYSWEEP Survey logging of TruePix data. Data is logged to *.R2S files. These files may become large, so don't select this option unless you wish to post-process the TruePix imagery.
- **Log Water Column Data:** Enables water column logging. Data is logged to *_WC.R2S files. These files will become **ridiculously** large.
- **TruePix Water Column:** Enable to log compressed water column data.
 - **Pass Through Port:** Specify the UDP port for HYSWEEP Survey to water column logger pass through. The default pass through port is 5656, which should work for the majority of situations. If data is not transferring, try 5657 instead.
- In R2Sonic Sonic Control, open the Operation Settings window and make sure TruePix Enable is checked in the Sonar tab, and Magnitude+Angle is selected as the TruePix data format in the Imagery tab.
- If TruePix Water Column is unchecked, then the full water column data is used, and the R2Sonic must be configured accordingly.

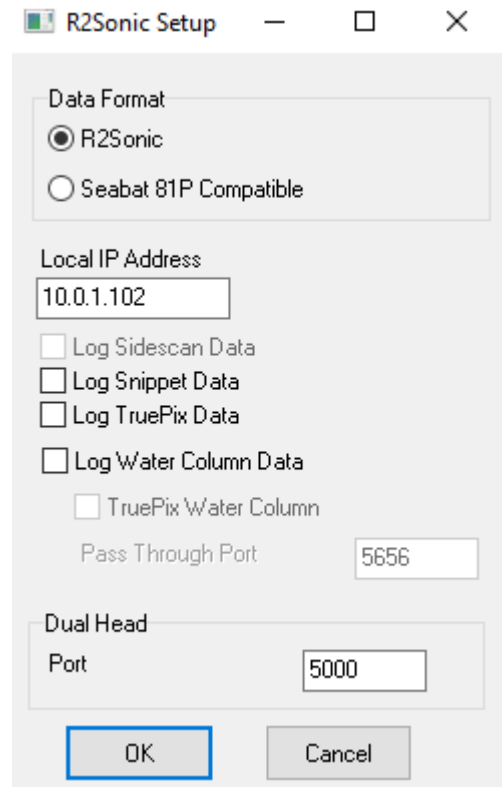

R2Sonic Setup

Data Format

R2Sonic

Seabat 81P Compatible

Local IP Address

10.0.1.102

Log Sidescan Data

Log Snippet Data

Log TruePix Data

Log Water Column Data

TruePix Water Column

Pass Through Port 5656

Dual Head

Port 5000

OK Cancel

Connection:

Network connection using UDP datagrams. Settings for the first sonar unit (head 1) are shown in the Connect tab of HYSWEEP Hardware. Default port (4000) and IP address (10.0.0.86) should be correct.

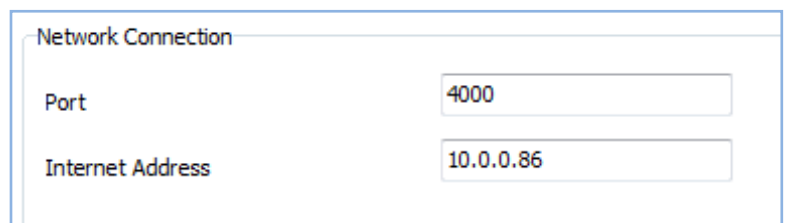

Network Connection

Port 4000

Internet Address 10.0.0.86

Settings for the second sonar unit (head 2) are fixed in HYSWEEP; port = 5000, IP address = 10.0.1.86.

Network Test:

Enter Port and IP Address to test head 1 or 2.

Offsets:

Enter head 1 and 2 location offsets relative to boat reference. Enter head 1 and 2 rotation offsets from patch testing.

Notes:

- The driver will not collect data unless both heads are pinging.
- The driver works properly in both R2Sonic ping modes; Alternate and Simultaneous.
- All R2Sonic models are supported (2024, 2022, etc.) and may even be mixed. For example, head 1 is 2024 sonar, head 2 is 2022.
- Ping rate (each head) should be limited to 20 times per second. This limitation allows the driver to accommodate Windows networking delays.

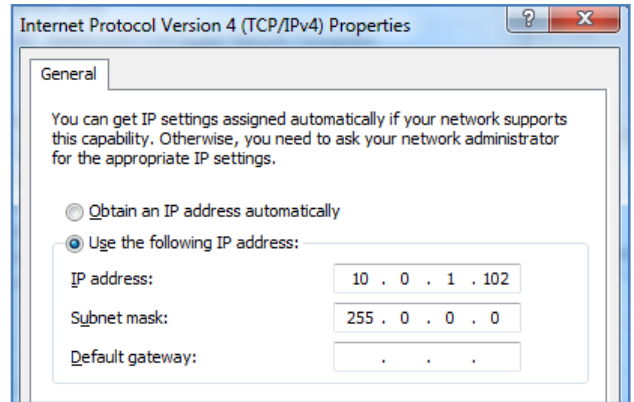

R2Sonic SONIC 2020, 2024

HYSWEEP driver for the R2Sonic SONIC 2020 or 2024 multibeam sonar. The R2SONIC 2024 driver also works with the 2022 model.

Setup Form:

- **Data Format:** Select R2Sonic mode.
- **Local IP Address:** We pass this to the sonar processor so it knows where to send data. This is the IP address of the computer running HYPACK / HYSWEEP.
- **Log Snippet/TruePix Data:** Enables HYSWEEP Survey logging of snippet or TruePix data. Data is logged to *.R2S files. These files may become very large, so don't select this option unless you wish to post-process the snippets/truepix imagery.
- **Log Water Column Data:** Enables water column logging starting with HYPACK 2015. Data is logged to *_WC.R2S files. These files will become **ridiculously** large.
- **TruePix Water Column:** Enable to log compressed water column data.
 - **Pass Through Port:** Specify the UDP port for HYSWEEP Survey to water column logger pass through. The default pass through port is 5656, which should work for the majority of situations. If data is not transferring, try 5657 instead.
- In R2Sonic Sonic Control, open the Operation Settings window and make sure TruePix Enable is checked in the Sonar tab, and Magnitude+Angle is selected as the TruePix data format in the Imagery tab.
- If TruePix Water Column is unchecked, then the full water column data is used, and the R2Sonic must be configured accordingly.

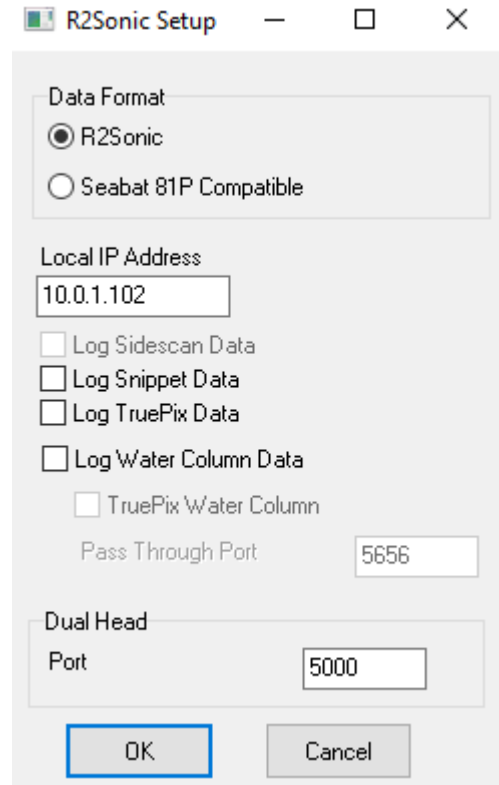

R2Sonic Setup

Data Format

R2Sonic

Seabat 81P Compatible

Local IP Address

10.0.1.102

Log Sidescan Data

Log Snippet Data

Log TruePix Data

Log Water Column Data

TruePix Water Column

Pass Through Port 5656

Dual Head

Port 5000

OK Cancel

Connection:

Network connection using UDP datagrams. The default port is 4000. Default IP address of the sonar unit is 10.0.0.86.

Offsets:

- **Starboard:** Sonar head location starboard of **boat center**.
- **Forward:** Sonar head location forward of **boat center**.
- **Vertical:** Sonar head location relative to waterline (positive).
- **Yaw, Pitch, Roll:** Sonar head rotations relative to forward and vertical. Enter values determined by patch testing.

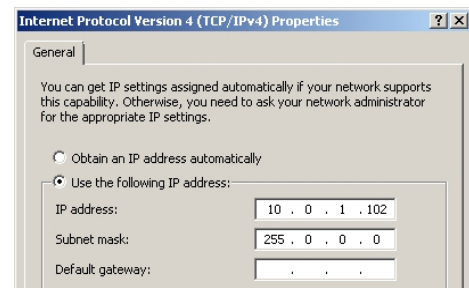

Internet Protocol Version 4 (TCP/IPv4) Properties

General

You can get IP settings assigned automatically if your network supports this capability. Otherwise, you need to ask your network administrator for the appropriate IP settings.

Obtain an IP address automatically

Use the following IP address:

IP address: 10 . 0 . 1 . 102

Subnet mask: 255 . 0 . 0 . 0

Default gateway: . . .

- **Latency:** Enter 0 – latency is automatically compensated.

Notes:

- Example setup of the network adapter is shown in the Internet Protocol Version 4 (TCP/IPv4) Properties window. The subnet mask is not typical.

TruePix Configuration:

For HYSWEEP 13.0.6 and earlier (see screenshot at the right):

- #1 only. – logging only, no display (for slow hardware only)
- #1 & #2. – logging, display in Intensity Window (recommended)
- #1, #2, & #3 – logging, display in Intensity and Sidescan Window (not recommended; not for large ranges, bigger HSX files)

HYSWEEP 13.0.7 and newer: simply check “Log TruePix Data” (see above).

In the R2Sonic software: go to Settings->Sonar Settings... Check either “TruePix Enable” or “Snippets Enable.”

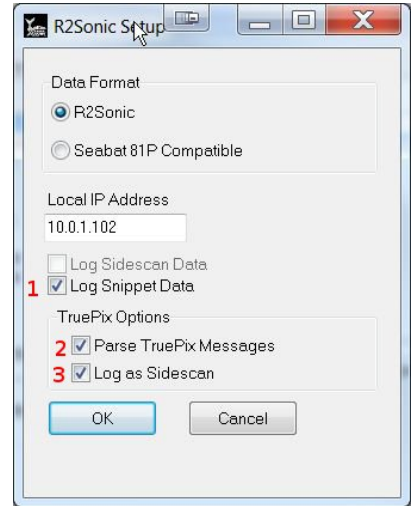

Dual Head Mode	Single head ▼	
TruePix Enable	<input checked="" type="checkbox"/>	<input type="checkbox"/>
Snippets Enable	<input checked="" type="checkbox"/>	<input type="checkbox"/>
Water Column Enable	<input type="checkbox"/>	<input type="checkbox"/>

R2Sonic SONIC 2024 (Seabat 81P compatible mode)

HYSWEEP driver for the R2Sonic SONIC 2024 multibeam sonar. Also works with the 2022 sonar. The compatibility mode allows all post processing tools that work with 81P systems to work with the R2Sonic. However, many of the advanced sonar features (sector rotation for example) are not available in the compatible mode.

Setup Form:

- **Data Format:** Select Seabat 81P Compatible to run in compatibility mode.
- **Log Sidescan Data:** Enables HYSWEEP Survey display and logging of sidescan data. Data is logged to *.HSX file along alongside the multibeam data. Sidescan data may be useful to the poor fellow who does the editing, and is therefore recommended.
- **Log Snippet Data:** Enables HYSWEEP Survey display and logging of snippet data. Data is logged to *.81X files. These files may become very large, so do not select this option unless you wish to post-process the snippets.
- **Log Water Column Data:** Enables water column logging starting with HYPACK 2015. Data is logged to *_WC.R2S files. These files will become **ridiculously** large.
- **TruePix Water Column:** Enable to log compressed water column data.
 - **Pass Through Port:** Specify the UDP port for HYSWEEP Survey to water column logger pass through. The default pass through port is 5656, which should work for the majority of situations. If data is not transferring, try 5657 instead.
 - In R2Sonic Sonic Control, open the Operation Settings window and make sure TruePix Enable is checked in the Sonar tab, and Magnitude+Angle is selected as the TruePix data format in the Imagery tab.
 - If TruePix Water Column is unchecked, then the full water column data is used, and the R2Sonic must be configured accordingly.

R2Sonic Setup

Data Format

R2Sonic

Seabat 81P Compatible

Local IP Address

10.0.1.102

Log Sidescan Data

Log Snippet Data

Log TruePix Data

Log Water Column Data

TruePix Water Column

Pass Through Port 5656

Dual Head

Port 5000

OK Cancel

Connection:

Network connection using UDP datagrams. The default port is 4000. Default IP address of the data collection computer is 10.0.0.86.

Offsets:

- **Starboard:** Sonar head location starboard of **boat center**.
- **Forward:** Sonar head location forward of **boat center**.
- **Vertical:** Sonar head location relative to waterline (positive).

- **Yaw, Pitch, Roll:** Sonar head rotations relative to forward and vertical. Enter values determined by patch testing.
- **Latency:** Enter 0 – latency is automatically compensated.

Notes:

- Was it mentioned that the 81X files are huge?

Renishaw SLM laser

Renishaw sold this product line to Carlson Software. See the Carlson Merlin section.

RIEGL LMS Series laser

HYSWEEP driver for the Riegl LMS series laser scanners. It has been tested with the Q120, Q240, and Z390 models. This driver requires the Riegl SDK dynamic libraries to be in the HYPACK directory or Windows search path (scannermod.dll and scancnfmod.dll) as well as a software license installed for riscalib using the Riegl License Manager. The license keys will be explicitly named "riscalib" or "riscalib3d" in the Riegl License Manager. The required DLLs and license manager software is provided by Riegl on their installation disks or via their support website. 3D models are supported in line scan mode only.

Setup Form:

Use the Setup form to configure the scanner's swath size and resolution. The Riegl libraries will change unsupported settings (those exceeding the parameters of the scanner) to the best supported fit. Of course, make sure the settings used are in line with your laser's operating constraints. The defaults are optimal for a Q120.

Head Rotation applies to 3D models only. By default this should be set to the value needed to point the laser off the starboard side of the boat for your mounting. Any other head rotation will require a corresponding offset correction. If you are using Riegl's RiSYNC product to output full timestamps from the laser, make sure that option is checked. If you are not using RiSYNC, you *must* not use this option or your data will be incorrectly timestamped. It is off by default.

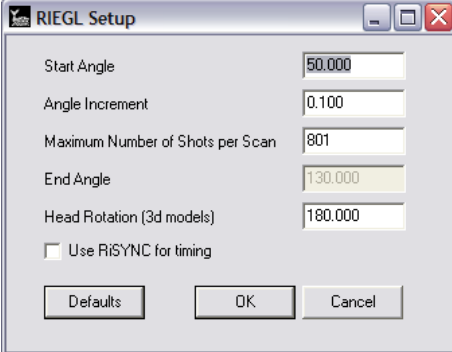

Connection:

Via a network interface. The Internet Address is 192.168.0.234 by default. The code assumes factory default port numbers of 20001 for data and 20002 for control.

Offsets:

HYSWEEP 13.0.6 and earlier:

- The driver currently assumes the laser is mounted pointing off the starboard side. It can be used pointing port-side if (1) 180 is added to the yaw offset and (2) the pitch and roll corrections are inverted. This can be done real-time in driver settings, or in post-processing.

HYSWEEP 13.0.7 and newer:

- Yaw, 2D models: +90 for starboard mount. -90 (or +260) for port mount.
- Yaw, 3D models: see Offsets section of the RIEGL V Series notes.

Notes:

- The scanner needs a GPS PPS pulse for accurate timestamps.
- Make sure the GPS and laser are powered on the same ground or laser may not read the pulse.
- You cannot run the Riegl acquisition software and HYSWEEP at the same time.

RIEGL V Series laser

HYSWEEP driver for the Riegl V series laser scanners. It has been tested with the VZ-400 model. This driver requires the Riegl **rivlib** libraries installed. The required DLLs and license manager software is provided by Riegl on their installation disks or via their support website. 3D models are supported in line scan mode only.

Setup Form:

Use the Setup form to configure the scanner's swath size and resolution. Of course, make sure the settings used are in line with your laser's operating constraints. Also configure how the laser will time sync (see below for more detail).

Mounting and Offsets:

Unlike the LMS series, changing the head rotation in the setup form **will not** require changing your yaw offset. However, the driver expects the laser's "zero" angle (front of the device) to be mounting pointing off starboard (pointing forward in HYSWEEP 13.0.7 and newer). If this is not the case, *then* you will need a yaw offset. We recommend mounting the laser in the above manner and simply changing the head rotation in the driver to shoot off the other side, rather than physically changing the mount.

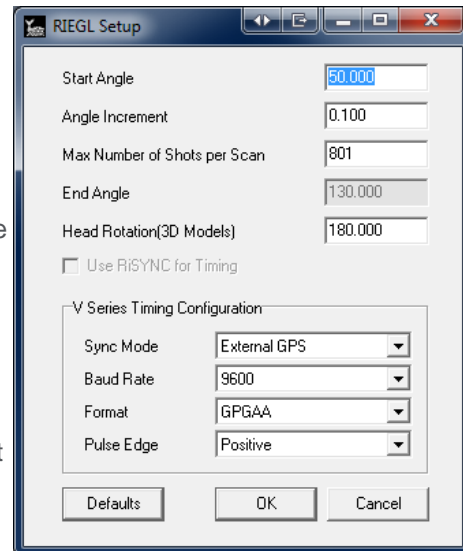

Connection:

Via a network interface. Set the IP address. The code assumes factory default port numbers of 20001 for data and 20002 for control.

Timesyncing:

Our driver *requires* proper timesyncing configuration of the laser. We strongly recommend 'External GPS' mode. To use this, split the GPS serial & PPS signals, sending it to both the laser and HYPACK through a PPS box. In some cases the laser may require the `GPS_EXT_SEQUENCE_TIMEOUT` setting changed to 1 if the laser fails to sync. This must be done by sending the following commands to the laser using the RiTerm program:

```
LOGIN("ICAN")
GPS_EXT_SEQUENCE_TIMEOUT=1
```

This can be saved to a text file and sent as a script with the RiTerm program. 'Internal GPS' mode will also work, but it is not recommended because the laser and HYPACK will be synched to different GPSs. If you are operating in UTC time, you'll see a 15s latency.

Note: the format code for GPZDA has been changed in firmwares which support Applanix POS syncing. HYPACK 2014 follows this convention. To sync a RIEGL with old firmware to GPZDA in HYPACK 2014, you may need to select "APPLANIX_POS" instead of GPZDA in the setup form.

Quality Codes:

The VZ400 provides flags to mark various "echoes" (useful in identifying returns from vegetation, etc.) which are logged as the following quality codes:

```
1--first echo
```

2--interior echo
3--last echo
4--single echo

Reson Dual 7125, T20-P, T50-P

Dual head configurations.

Setup Form:

Refer to Seabat 7125, T20-P, etc. section for most settings.

Dual Head

- **Integrated Dual Head:** Check this for newer IDH systems.
- **Slave IP Address:** Enter IP address of slave controller. Not used with IDH.
- **Log / Merge Snippet Datagrams:** Select 1 or 2 files for *.7K datagrams. Selection depends on what post processing software prefers.
- **Merge Sidescan:** Merges sidescan into a single record; port side imagery, port head + starboard side imagery, starboard head. If unchecked heads are logged independently.
- **Swap Sides:** In case head 1 and 2 are reversed in merged sidescan.

Pass through data is not available for dual head in HYPACK 2021.

The screenshot shows the 'Reson Setup' dialog box with the following settings:

- Side Scan Option
- Use Snippets
- Log Seabat Datagrams
- Snippets from 7058 Datagram
- 7K Drivers**
 - Datagram Version 1
 - Datagram Version 2
- Warning: Patch test offsets may change when switching between datagram versions.**
- Snippet Samples per Beam**
 - Auto
 - Min: 5
 - Max: 25
- Send Start and Stop Logging Commands to the Seabat
 - Send HYSWEEP Full Path
 - Send HYSWEEP File Name Only (M_ and S_ prefix for dual head)
 - Do Not Send a File Name
- Use RESON Remote IO (Base Port: 2020)
- Log Water Column
 - Use 7042 Compressed Water Column Data
 - Use Pass Through Position, Heading and MRU
 - Use Rotator Data
- Dual Head**
 - Integrated Dual Head
 - Slave IP Address: []
 - Log Head 1,2 Snippet Datagrams to Separate Files
 - Merge Head 1,2 Snippet Datagrams into a Single File
 - Merge Sidescan
 - Swap Sides

Buttons: OK, Cancel

Connection:

Use the Connect tab to enter the IP Address of the master. Network port will always be 7000.

Offsets - For each head, enter the following:

- **Starboard:** Sonar head location starboard of **boat center**.
- **Forward:** Sonar head location forward of **boat center**.
- **Vertical:** Sonar head location relative to waterline (positive).
- **Yaw, Pitch, Roll:** Sonar head rotations relative to forward and vertical. Enter values determined by patch testing.
- **Latency:** Enter 0 – latency is automatically compensated.

Notes:

- Supports Seabat version 2 datagrams. Version 1 is not supported.

- Side scan data is collected from both heads and selected by channel.
- 7125: HYSWEEP Sonar head 1 is the master and must be mounted on the port side with the connector to the left (as per Reson documentation). HYWEEP sonar head 2 is the slave mounted facing starboard. Again, with the connector on the left.
- 7125: In the Tetra Tech installation, master IP address = 192.168.3.50, slave = 192.168.3.49.

Reson Dual 8101 (NY)

HYSWEEP driver for the dual Seabat 8101 system installed on USACE S/V Moritz.

Setup Form:

The only thing that need be entered is the COM Port for Time Sync. This is important for proper time tagging of the multibeam data.

Connection:

Multibeam and Sidescan data are via network interface. Network port is hard wired to 1029 (head 1) and 1038 (head 2).

Offsets:

For the port and starboard heads, enter:

- **Starboard, Forward, Vertical** offsets relative to the boat origin / water line.
- **Yaw, Pitch, Roll:** Sonar head rotations relative to forward and vertical. Enter values determined by patch testing.
- **Latency:** Enter 0 – latency is automatically compensated.

The screenshot shows the 'Reson Setup' dialog box. It features a blue title bar with the text 'Reson Setup' and standard window control buttons (minimize, maximize, close). The main area is light beige and contains the following elements:

- A checked checkbox labeled 'Side Scan Option'.
- A section titled '8101 Driver' containing two text input fields: 'Number of Beams' with the value '101' and 'Network Port' with the value '1028'.
- A section titled '81xx Network Driver' containing a label 'COM Port for Time Sync (9600 Baud)' and a dropdown menu currently displaying 'COM5'.
- At the bottom right, there are two buttons: 'OK' and 'Cancel'.

Seabat Setup

The IP address of the HYPACK PC must match the remote address entered in the port and starboard Seabat controllers.

Notes:

Reson Odom MB2

MB2 multibeam using the Teledyne-Reson 7K interface.

Setup Form:

MB2

Side Scan Option

Use Snippets

Draw Snippets

Log Seabat Datagrams

Snippet Samples per Beam

Auto

Min

Max

Send Start and Stop Logging Commands to the Seabat

Use RESON Remote IO

Base Port

Log Water Column

OK Cancel

- **Side Scan Option:** Check this to enable side scan data.
- **Use Snippets:** Check this to use Seabat snippet data.
- **Draw Snippets:** Uncheck this if real time snippet display causes problems. Snippets are still logged.
- **Log Seabat Datagrams:** Use this to log raw network datagrams to *.7K files. This is done automatically if snippets are enabled.
- **Snippet Samples per Beam:** Option for variable samples per beam. 1118 command to MB2.
 - **Auto:** Snippet samples per beam chosen for 3 dB overlap. Results in much less data than constant samples per beam.
 - **Min:** Minimum Window Size. Include at *least* this number of samples around bottom detection.
 - **Max:** Maximum Window Size. Include at *most* this number of samples.

- **Send Start and Stop Logging Commands to the Seabat:** Causes the MB2 to log data files with the same name as HYPACK files. The options (full path, name only) kick off various naming modes in the Seabat controller. See “7K Data Format” from Teledyne-Reson.
- **Use RESON Remote IO:** Reads time tagged motion and heading data from the selected network port.
- **Log Water Column:** Enables water column logging starting with HYPACK 2015. Data is logged to *_WC.7K files. The 7042 datagram is recommended to minimize file sizes.

Connection:

Multibeam and side scan data are via a network interface. Set port number to 7000 and use the Internet Address of the 7K controller.

Offsets:

- **Starboard:** Sonar head location starboard of **boat center**.
- **Forward:** Sonar head location forward of **boat center**.
- **Vertical:** Sonar head location relative to waterline (positive).
- **Yaw, Pitch, Roll:** Sonar head rotations relative to forward and vertical. Enter values determined by patch testing.
- **Latency:** Enter 0 – latency is automatically compensated.

Notes:

Reson Seabat 7101, 7125, 7150, 7160, 8125H, T20-P, T50-P, T51

HYSWEEP driver for the Reson Seabat 7k multibeam sonar systems. Uses a network interface to provide multibeam soundings, side scan, snippet and water column data.

Setup Form:

- **Side Scan Option:** Check this to enable side scan data.
- **Use Snippets:** Check this to use Seabat snippet data. See Notes.
- **Log Seabat Datagrams:** Use this to log raw network datagrams to *.7K files. This is done automatically if snippets are enabled.
- **Datagram Version 1:** Original data format used by Reson. You can use this until the Seabat is updated to a version that doesn't support it.
- **Datagram Version 2:** Updated format available in 2010. This is an improvement over version 1 in that snippet data is compressed and beam data is completely uncorrected.
- **Snippet Samples per Beam (Version 1):** All beams contain the same number of snippet samples. 1103 command to Seabat.
 - **Auto:** N/A.
 - **Min:** N/A.
 - **Max:** Selects snippet samples per beam.
- **Snippet Samples per Beam (Version 2):** Option for variable samples per beam. 1118 command to Seabat.
 - **Auto:** Snippet samples per beam chosen for 3 dB overlap. Results in much less data than constant samples per beam.
 - **Min:** Minimum Window Size. Include at *least* this number of samples around bottom detection.
 - **Max:** Maximum Window Size. Include at *most* this number of samples.

Reson Setup

Side Scan Option Use Snippets Log Seabat Datagrams
 Snippets from 7058 Datagram

7K Drivers

Datagram Version 1
 Datagram Version 2

Warning: Patch test offsets may change when switching between datagram versions.

Snippet Samples per Beam

Auto
Min: 5
Max: 25

Send Start and Stop Logging Commands to the Seabat

Send HYSWEEP Full Path
 Send HYSWEEP File Name Only (M_ and S_ prefix for dual head)
 Do Not Send a File Name

Use RESON Remote IO Base Port: 2020

Log Water Column
 Use 7042 Compressed Water Column Data

Use Pass Through Position, Heading and MRU
 Use Rotator Data

Dual Head

Integrated Dual Head
Slave IP Address:

Log Head 1,2 Snippet Datagrams to Separate Files
 Merge Head 1,2 Snippet Datagrams into a Single File

Merge Sidescan Swap Sides

OK Cancel

- **Send Start and Stop Logging Commands to the Seabat:** Causes the Seabat to log data files with the same name as HYPACK files. The options (full path, name only) kick off various naming modes in the Seabat controller. See “7K Data Format” from Teledyne-Reson.
- **Use RESON Remote IO:** Reads time tagged motion and heading data from the selected network port.
- **Log Water Column:** Enables water column logging starting with HYPACK 2015. Data is logged to *_WC.7K files. The 7042 datagram is recommended to minimize file sizes.
- **Use Pass Through Position, Heading and MRU:** Takes data from 7K datagrams. Heading and MRU are logged directly to HSX. Position can be used for HYPACK survey navigation. See Appendix D for navigation setup.
- **Use Rotator Data:** Takes pan and tilt from 7K datagrams. Used for rotating head configuration.

Connection:

Multibeam and side scan data are via a network interface. Set port number to 7000 and use the Internet Address of the 7125 controller.

Offsets:

- **Starboard:** Sonar head location starboard of **boat center**.
- **Forward:** Sonar head location forward of **boat center**.
- **Vertical:** Sonar head location relative to waterline (positive).
- **Yaw, Pitch, Roll:** Sonar head rotations relative to forward and vertical. Enter values determined by patch testing.
- **Latency:** Enter 0 – latency is automatically compensated.

Notes:

- Although it is possible to switch the 7125 between equal beam spacing (256 beams) and equal footprint (512 beams), you should decide which is better for you and stick with that for the entire survey. This will avoid potential problems in HYSWEEP post-processing.
- The 7125 controller must be powered on before starting HYSWEEP survey.
- **Snippets** – If snippets are enabled in the driver and turned on in the Seabat, a couple of things happen.
 - The Intensity Waterfall will show snippets instead of intensity.
 - Large files containing raw Seabat datagrams (*.7K) are logged for snippet post processing.
 - You must be careful with snippets using the Version 1 datagrams. Say you are pinging 40 times per second in shallow water, using 512 beams at equal spacing and saving 300 snippet samples per beam (300 is the Seabat default). 2 bytes per sample. You will then try to collect $40 * 512 * 300 * 2 = 12,288,000$ bytes per second = 0.75 Gigabytes / minute. NO! The network will likely choke and even if it doesn't, this is too much for the GSF files used in snippet post processing. Cut down the number of samples to 50 or less if you ping at high rates in shallow water. 25 pings per second, 25 snippet samples per beam is reasonable.
 - Snippet data is optimized (much less data!) using the version 2 datagrams.

Reson Seabat 8101

HYSWEEP driver for Reson Seabat 8101 Multibeam sonar / sidescan.

Setup Form:

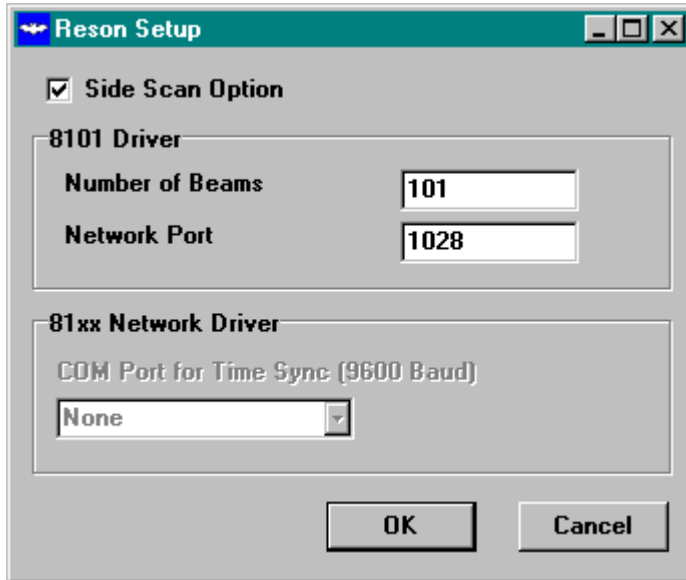

The screenshot shows a 'Reson Setup' dialog box. It features a title bar with a green background and standard window controls. The main area is divided into sections. The first section has a checked checkbox labeled 'Side Scan Option'. Below this is a section titled '8101 Driver' containing two input fields: 'Number of Beams' with the value '101' and 'Network Port' with the value '1028'. The next section is titled '81xx Network Driver' and contains a label 'COM Port for Time Sync (9600 Baud)' above a dropdown menu currently set to 'None'. At the bottom of the dialog are 'OK' and 'Cancel' buttons.

Enter the number of beams you are using (101 for 150 degree swath, 141 for 210 degree swath). If the Seabat is set up for sidescan output, check “Side Scan Option”. The default port = 1028 should not need to be changed.

Connection:

Multibeam data is via an RS232 interface (binary). Sidescan uses the network.

Offsets:

- **Starboard:** Sonar head location starboard of **boat center**.
- **Forward:** Sonar head location forward of **boat center**.
- **Vertical:** Sonar head location relative to waterline (positive).
- **Yaw, Pitch, Roll:** Sonar head rotations relative to forward and vertical. Enter values determined by patch testing.
- **Latency:** Enter 0 – latency is automatically compensated.

Seabat Setup

The Remote IP address must match the address of the HYPACK/HYSWEEP computer. If you don't know how to set up IP addresses, consult the office network guru.

Notes:

Reson Seabat 81xx (Network)

HYSWEEP driver for Reson Seabat 8124, 8125 and some 8101 multibeam sonar models. This driver is appropriate when using the network interface for data transfer. Provides multibeam soundings and sidescan data.

Setup Form:

- **Side Scan Option:** Check this to enable side scan data.
- **Use Snippets:** Check this to use Seabat snippet data. See Notes.
- **Log Seabat Datagrams:** Use this to log raw network datagrams to *.81X files.
- **COM Port for Time Sync:** When using this driver, it is necessary to time synchronize the Seabat sonar unit with the HYPACK / HYSWEEP computer. That is done through the COM port specified here.

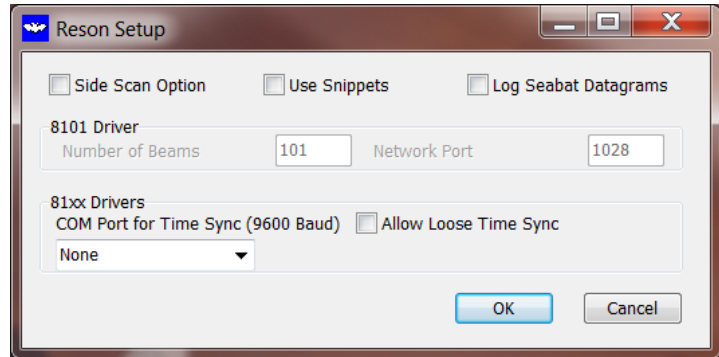

Connection:

Multibeam and side scan data are via a network interface. Set port number to match the Seabat controller (1028 by default) and use the default Internet Address (127.0.0.1).

Offsets:

- **Starboard:** Sonar head location starboard of **boat center**.
- **Forward:** Sonar head location forward of **boat center**.
- **Vertical:** Sonar head location relative to waterline (positive).
- **Yaw, Pitch, Roll:** Sonar head rotations relative to forward and vertical. Enter values determined by patch testing.
- **Latency:** Enter 0 – latency is automatically compensated.

Seabat Setup

Ethernet Port should be 1028 and the Remote IP address must match the address of the HYPACK / HYSWEEP computer.

Notes:

- **Intensity** – Intensity (average backscatter) data is collected and display when the RI-Theta message is sent by the Seabat. I=Intensity.
- **Snippets** – If snippets are enabled in the driver and turned on in the Seabat, a couple of things happen.
 - The Intensity Waterfall will show snippets instead of intensity.
 - Large files containing raw Seabat datagrams (*.81X) are logged for snippet post processing.

Reson Seabat 81xx (Serial)

HYSWEEP driver for Reson Seabat 8124, 8125 and some 8101 multibeam sonar models. This driver is appropriate when using the serial (COM port) interface for data transfer.

Connection:

Multibeam data is via an RS232 interface (binary).

Offsets:

- **Starboard:** Sonar head location starboard of **boat center**.
- **Forward:** Sonar head location forward of **boat center**.
- **Vertical:** Sonar head location relative to waterline (positive).
- **Yaw, Pitch, Roll:** Sonar head rotations relative to forward and vertical. Enter values determined by patch testing.
- **Latency:** Enter 0 – latency is automatically compensated.

Notes:

Reson Seabat 9001 / 9003

HYSWEEP driver for Reson Seabat 9001 / 9003 Multibeam sonar.

Connection:

RS232 Serial interface, binary message. HYSWEEP survey accepts both the R-Theta (Range - Angle) and RI-Theta (Range, Intensity – Angle) messages from the 9001, R-Theta only from the 9003.

Offsets:

- **Starboard:** Sonar head location starboard of **boat center**.
- **Forward:** Sonar head location forward of **boat center**.
- **Vertical:** Sonar head location relative to waterline (positive).
- **Yaw, Pitch, Roll:** Sonar head rotations relative to forward and vertical. Enter values determined by patch testing.
- **Latency:** Enter 0 – latency is automatically compensated.

Notes:

- The 9001 has 60 beams at 1.5 degree spacing for a swath of 90 degrees.
- The 9003 has 40 beams at 3.0 degree spacing for a swath of 120 degrees.

Ross Smart Sweep

HYSWEEP driver for Ross Smart Sweep multiple transducer system.

Connection:

RS232 Serial interface, ASCII message.

```
$SDRSW,cc,xxx.x,xxx.x,xxx.x,xxx.x,xxx.x,xxx.x,xxx.x,xxx.x,xxx.x,xxx.x,xxx.x,xxx.x,xxx.x,xxx.x,f[CR][LF]
```

Where:

- **cc**: Channel Count (number of depths in string, from 3 to 16).
- **xxx.x**: Multi-track depths (3 to 16).
- **f or M**: Depth units: f=feet, M=meters

Offsets – Transducers 1 through 16 (max):

- **Starboard**: Transducer position starboard of **boat center**.
- **Forward**: Transducer position forward of **boat center**.
- **Vertical**: Transducer draft (positive).
- **Yaw, Pitch, Roll**: All zeros.
- **Latency**: Enter the latency time (positive, seconds) appropriate for each transducer.

Notes:

SBG Systems Ekinox

HYSWEEP driver for SBG systems inertial devices (Ekinox, Ellipse, etc.). Position and motion (pitch, roll, heave and heading) data.

Connection:

The HYSWEEP driver takes data in UDP datagrams. Datagrams come directly from the SBG (in the case of Ekinox) or from the SBG driver in HYPACK survey (Ellipse). Connect settings shown below are from Ellipse via the HYPACK driver.

UDP network port = 5656

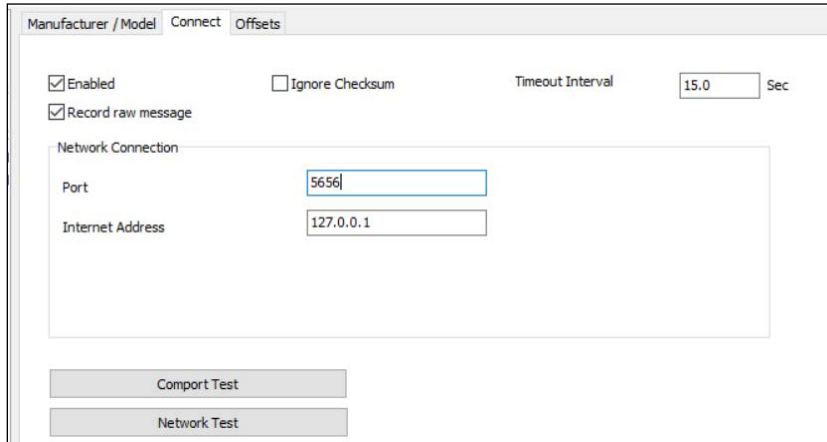

The screenshot shows a configuration window with three tabs: "Manufacturer / Model", "Connect", and "Offsets". The "Connect" tab is active. It contains the following settings:

- Enabled
- Ignore Checksum
- Timeout Interval: 15.0 Sec
- Record raw message
- Network Connection section:
 - Port: 5656
 - Internet Address: 127.0.0.1
- Buttons: "Comport Test" and "Network Test"

Connect settings for the Ekinox aren't readily obvious. Although in one case Network Port 9000 was used.

Offsets - MRU:

Starboard, Forward, Vertical:

Typically, IMU reference point location starboard, forward or below **boat center**.

For installations with IMU mounting at or on the sonar, 0,0 may be used for horizontal offsets, effectively using the sonar as reference point. This is tricky though. It's best to discuss reference point location with HYPACK support.

Yaw, Pitch, Roll:

Typically all zero, as needed corrections are made within SBG configuration.

Latency:

Enter 0.

Offsets - Gyro:

Enter 0 for all offsets and latency.

Setup:

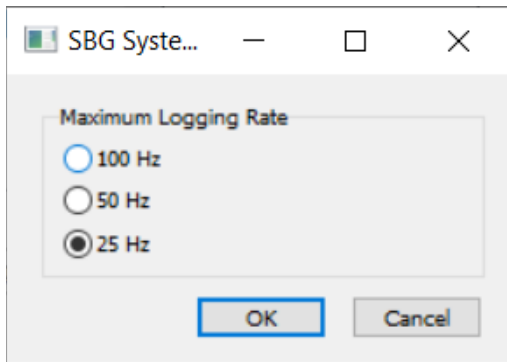

Typically, 25 Hz is fast enough. But if you want more data (and larger files) the 50 and 100 Hz options are available.

Seabeam 1000 Series

HYSWEEP driver for the Seabeam 1000 series of multibeam sonar systems. Supported models are:

- **SB1185** - 0-300 m depth, 180 khz
- **SB1180** - 0-600 m depth, 180 khz
- **SB1055** - 0-1500 m depth, 50 khz
- **SB1050** - 0-3500 m depth, 50 khz
- **SB1055D** - SB1180 + SB1055 (dual frequency)
- **SB1050D** - SB1180 + SB1050 (dual frequency)

All provide roll corrected multibeam soundings along with HPR data. A Seabeam program, Hydrostar Online, runs in the same PC as HYPACK/HYSWEEP. Hydrostar controls the sonar and provides the sounding and MRU data to HYSWEEP survey.

Setup Form:

Record XSE Records: Check this to save raw messages from the Hydrostar program. Useful only for diagnostics and filling up a disk drive.

Record Beam Intensity: Check this to save beam intensity values for use in multibeam editing. Intensity is displayed in the HYSWEEP multibeam waterfall display.

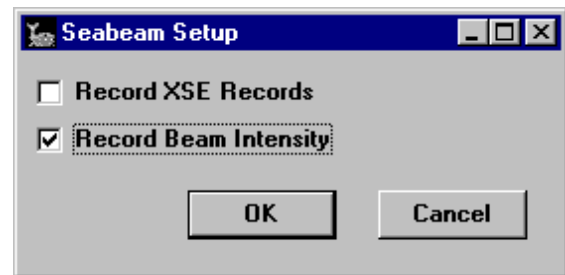

Connection:

Multibeam data is via a network interface internal to the PC (no wires!). Use Internet Address = 127.0.0.1 and Port = 3400.

Offsets - MRU:

- **Starboard:** MRU location starboard of **boat center**.
- **Forward:** MRU location forward of **boat center**.
- **Vertical:** MRU location relative to waterline (positive below).
- **Yaw:** Enter 0.
- **Pitch, Roll:** Enter 0 (MRU pitch/roll offsets are typically zeroed within the MRU itself).
- **Latency:** Enter 0.

Offsets – Sonar Heads 1 and 2:

- **Starboard:** Sonar head locations starboard of **boat center**.
- **Forward:** Sonar head locations forward of **boat center**.
- **Vertical:** Sonar head locations relative to waterline (positive).
- **Yaw, Pitch:** Sonar head rotations. Enter values determined by patch testing in HYSWEEP hardware.

- **Roll:** Sonar head rotations from patch test. Enter values under Hydrostar ship parameters, NOT HYSWEEP (0 in HYSWEEP).
- **Latency:** Enter 0.

Notes:

- **Dual Head Systems:** Separate and different offsets exist for each set of transducers. The surveyor must remember to enter the offsets appropriate for the transducers used in the survey.
- **Quality Coding:** The Hydrostar online program encodes sounding quality; 1 = high quality to 8 = low quality to 9 = bad. HYSWEEP requires the reverse ordering so HYSWEEP quality = 9 – Hydrostar quality.

Sounding Quality	Hydrostar Code	HYSWEEP Code
Excellent	1	8
Poor	8	1
No Good	9	0

- When the number of beams is changed during survey it affects the editing process. Enter Fixed Number of Beams = 126 in Mbmax Read Parameters, Advanced tab (below). 126 is the maximum number of beams available in the system.

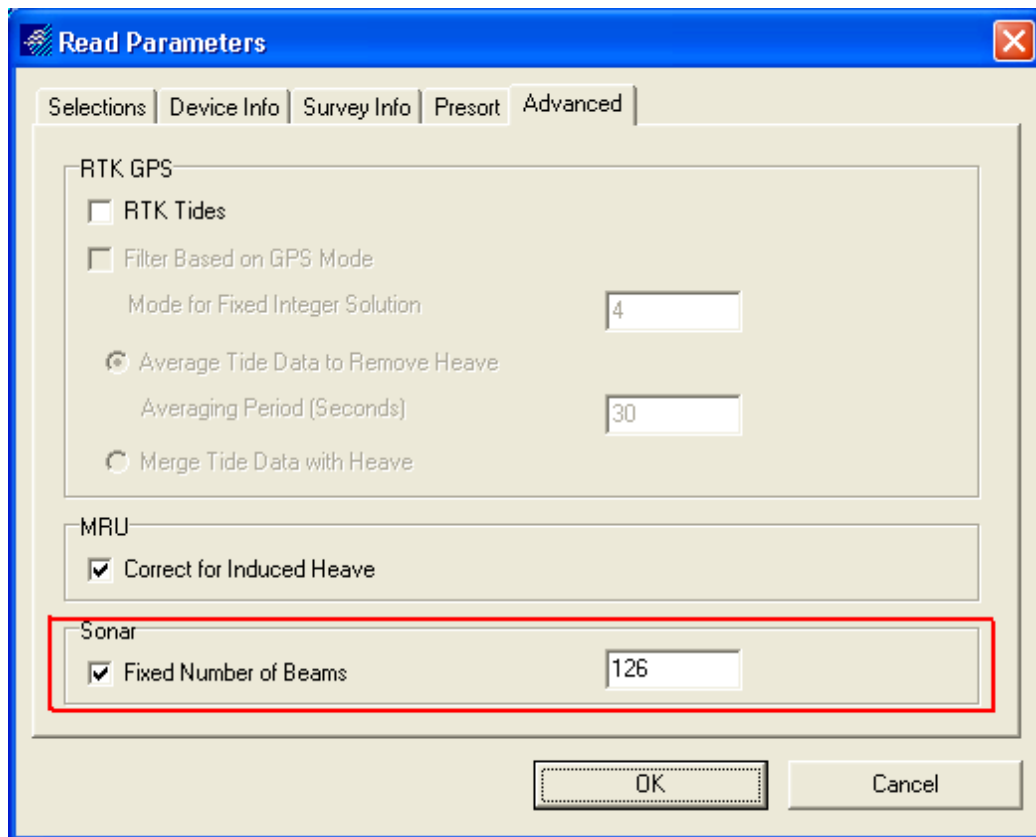

Seabeam 2100

HYSWEEP driver for Seabeam 2100 multibeam sonar. The driver provides heave, pitch, roll and sound velocity corrected soundings. Heading information is included in the 2100 datagram.

Connection:

TCP/IP connection. Use Internet Address = 127.0.0.1 and Port = 5209 in HYSWEEP Hardware. (The PC must have IP address matching the 2100 "Sea Logger" address – 198.114.228.32 in one installation.)

Offsets - Gyro:

- **Starboard, Forward and Vertical:** Enter 0.
- **Yaw, Pitch and Roll:** Enter 0.
- **Latency:** Enter 0.

Offsets – Sonar Head:

- **Starboard and Forward:** Enter transducer position relative to boat reference.
- **Vertical:** Enter 0 – Draft is entered in 2100 Operators Station.
- **Yaw:** Enter the calibration offset.
- **Pitch and Roll:** Enter 0 – These are entered in 2100 Operators Station..
- **Latency:** Enter 0.

Notes:

- Because sounding corrections are done before data is sent to HYSWEEP, data cannot be re-corrected later.
- As with all network interfaces, both the HYPACK PC and the remote computer (2100 operators station) must be time synchronized to GPS time using the \$GPZDA message.

Seabeam 3000 Series

HYSWEEP driver for the Seabeam 3000 series multibeam sonar. Supports:

- **3012** – 12 kHz deep water system.
- **3020** – 20 kHz deep water system.
- **3030** – 30 kHz version of 3050.
- **3050** – 50 kHz medium depth system.

All provide yaw, roll and pitch stabilized soundings. Hydrostar Online (Seabeam program) runs on the same PC as HYPACK/HYSWEEP for sonar control.

Setup Form:

- **Record XSE Records:** Check this to save raw messages from the Hydrostar program. Useful for diagnostics and filling up a disk drive.
- **Record Beam Intensity:** Check this to save beam intensity for editing or mapping. Intensity is displayed in the Intensity Waterfall.

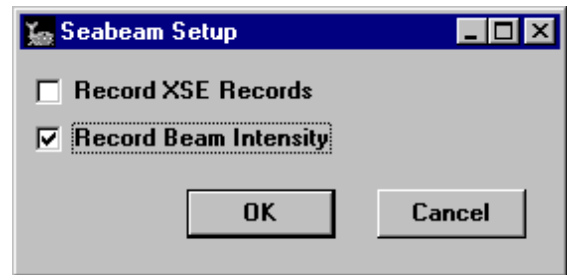

Connection:

Data is via a network interface internal to the PC. Use Internet Address = 127.0.0.1 and Port = 3400.

Offsets – Sonar Head:

- **Starboard:** Sonar head location starboard of **boat center**.
- **Forward:** Sonar head location forward of **boat center**.
- **Vertical:** Sonar head location relative to waterline (positive).
- **Yaw, Pitch, Roll:** Enter patch calibration offsets in Hydrostar. Enter 0 in HYSWEEP.
- **Latency:** Enter 0.

Notes:

- **Quality Coding:** The Hydrostar online program encodes sounding quality; 1 = high quality to 8 = low quality to 9 = bad. HYSWEEP requires the reverse ordering so HYSWEEP quality = 9 – Hydrostar quality.

Sounding Quality	Hydrostar Code	HYSWEEP Code
Excellent	1	8
Poor	8	1
No Good	9	0

- When the number of beams is changed during survey it effects the editing process. Enter Fixed Number of Beams = the maximum during the survey in MBMAX Read Parameters, Advanced tab.

Seatex MRU6

HYSWEEP driver for the Seatex MRU6 motion reference unit. Provides heave, pitch and roll data.

Connection:

RS232 Serial interface, binary message.

Offsets:

- **Starboard:** MRU location starboard of **boat center**.
- **Forward:** MRU location forward of **boat center**.
- **Vertical:** MRU location relative to waterline (positive below).
- **Yaw:** Enter 0.
- **Pitch, Roll:** Enter 0 (MRU pitch/roll offsets are typically zeroed within the MRU itself).
- **Latency:** Enter 0.

Notes:

- HYSWEEP uses the COM port to program the MRU6 to send a particular message. If message is not received by the MRU6, due to starting HYSWEEP survey before the MRU6 or a broken or missing transmit wire (it's happened), the driver will not work.
- The MRU6 can be set to output a "Sounder" message, which is identical to the TSS 335B message.

SG Brown 1000S Gyro

Driver for the SG Brown gyro.

Connection:

RS232 Serial interface. An example message is shown below:

```
XXXX<cr><lf>
^^^^
||||- 1/6th (degrees), HUH?
|||-- units (degrees)
| |-- tens (degrees)
|---- hundreds (degrees)
```

Offsets:

- **Starboard, Forward, Vertical:** Not used – set to 0.
- **Yaw:** Enter the heading correction if any.
- **Pitch, Roll:** Not used – set to 0.
- **Latency:** Enter the gyro latency time if any - positive, seconds.

Notes:

SEA SWATHplus and Bathyswath

Driver for the SEA SWATHplus interferometric sonar. Provides multibeam soundings, beam intensity, beam quality, and sidescan. We can also optionally receive motion and heading data from the SWATHplus, timetagged by the SWATH Processor software (from SEA).

Setup:

Each ping, SWATHplus sends thousands of range / angle / amplitude samples to HYSWEEP survey. These are reduced to a manageable number of beams in HYSWEEP Survey using the filtering and downsampling routines available in the HYSWEEP Interferometry window (See [Appendix C](#)).

SXI format files can be logged alongside HSX by checking the “Record Raw Message” option on the Connect tab.

Connection:

All data is via the network. The SWATHplus software must be configured to pass data over the network in the following manner. First, in the directory for the SWATHplus software, edit the file called “swathproconfig.txt” and enable the 'synsocket' option by changing 0 to 1. Next, configure SWATHplus by clicking the “TCP/IP Socket” button in the Swath Processor software. You will get the “Socket Properties” dialog. Configure like the screenshot to the right, using the HYPACK computer's IP address. Use the same IP address and port in HYSWEEP Hardware. The default port is 5001.

Click Tools->Parsed Data Settings to modify the filter parameters sent to HYSWEEP if you wish to utilize SEA filtering routines. You may turn all these off and use only HYPACK filtering and downsampling if you prefer. In this case, turn on the 'Suppress processing after sending data on socket' option in Swath Processor.

Offsets – Sonar Heads 1 and 2:

- **Starboard:** Sonar head locations starboard of **boat reference**.
- **Forward:** Sonar head locations forward of **boat reference**.
- **Vertical:** Sonar head locations relative to waterline (positive).
- **Yaw, Pitch, Roll:** Sonar head rotations - enter values determined by patch testing.
- **Latency:** Enter 0.

Notes:

- Two programs are required: Swath Processor from SEA and HYPACK / HYSWEEP. If run on the same computer, it is recommended that Swath Processor displays are not used to minimize CPU load.

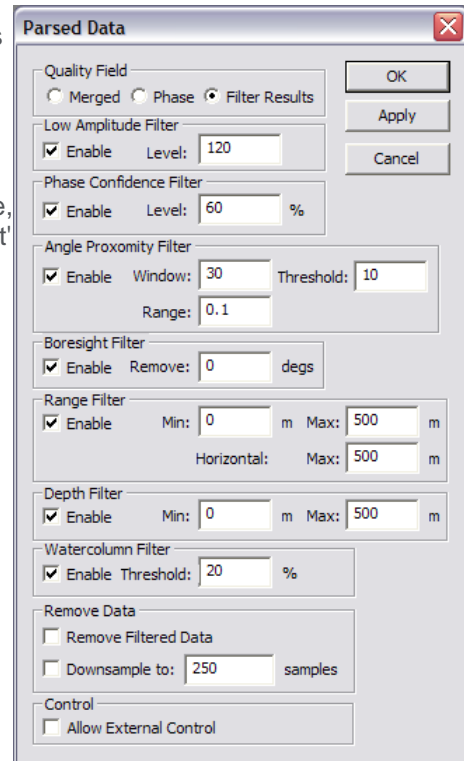
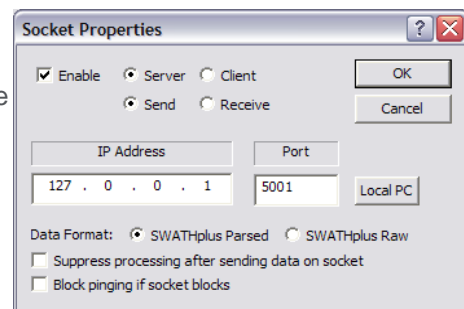

- If you are running Swath Processor and HYPACK on different computers they must be time synchronized. This is done by time synchronizing both to GPS time (requiring a HYPACK 1PPS box).
- Do not use the SEA downsample option as this will mangle the sidescan imagery.
- Quality codes for 'Filter Results' mode are set 0-8 based on # SEA filters *passed*
- 2019: Swathplus retired for Bathyswath; however, the bathyswath is identical in interacting with HYSWEEP. Two identical drivers to help avoid customers' confusion per manufacturer's request.

Tritech Gemini Profiler

The Trittech Gemini is a profiler that can stand-alone, or interface through the Trittech Gemini hub, which provides timestamping and communications services. The Gemini can also be operated in dual head mode through a Gemini hub.

Connection:

Communication is over a network connection via UDP on port 52905 by default.

Setup:

Check dual head if using a two profilers.

If sending motion data through the Gemini Hub, select which port on the hub contains which data string. The driver expects TSS1 on the MRU port and HDT strings on the Gyro port.

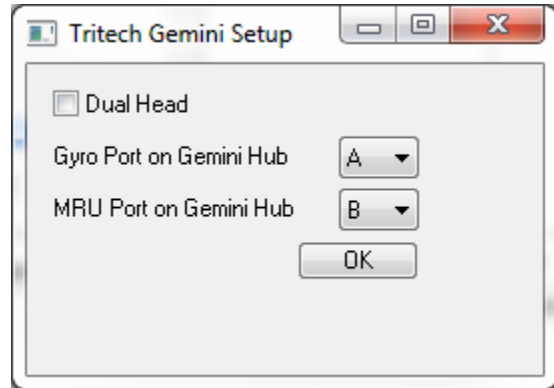

Tritech SeaKing

HYSWEEP driver for the Tritech scanning sonar. This device mechanically scans the bottom and HYSWEEP converts the results into pseudo-multibeam.

Setup:

- Check **“Two Head Operation”** if you want to use 2 profilers. As of August, 2005 there may still be some glitches in the 2 head mode.
- **Transducer Eye...** The transducer may be mounted with the “Eye” up or down. Down is the normal (default) mode. Check accordingly.
- **Maximum soundings per head** is how we convert from scanning sonar to pseudo-multibeam. Once you settle on a good value for this, you cannot change it for the duration of the survey. If you do, the processing will screw up and you are SOL.
- The **Lag Angle** compensates for mechanical lag in the scanning transducer.



Connection:

RS232 Serial interface, with a complication ASCII message. We use the RAW message with delta time mode. A sample message:

```
%D0257022501+00015-00020+00025-00030+000000010404432 ...
```

Field	Start Char	Length	Description
1	0	1	synch sequence = %D
2	2	4	number of bytes in message
3	6	2	slot number, 20 = master (head 1), 21 = slave (head 2)
4	8	2	device type, 25=profiler
5	10	1	0 = ascii text mode
6	11	1	1 = raw data
7	12	6	1st offset - horizontal X pos in mm
8	18	6	2nd offset - vertical Y pos in mm
9	24	6	3rd offset - longitudinal Z pos in mm
a	30	6	4th offset - rotational R pos in 1/10 grad
b	36	6	echo ranging time correction in usec
c	42	5	number of profile samples
d	47	5	scan start angle in 1/16 gradians
e	52	4	step size and direction in 1/16 grad
f	56	5	sv in dm/sec
g	61	8	time at start of scan hhmmsshh
h	69	5	duration of scan in msec
i	74	3	000 = upright orientation
j	77+5*#	5	range in useconds

Pay attention that field 6 = 1 for raw data. Processed data has a different code and won't work right.

Offsets:

- **Starboard:** Sonar head location starboard of **boat center**.
- **Forward:** Sonar head location forward of **boat center**.
- **Vertical:** Sonar head location relative to waterline (positive).
- **Yaw, Pitch, Roll:** Sonar head rotations relative to forward and vertical. Enter values determined by patch testing.
- **Latency:** Enter 0 – latency is automatically compensated.

Notes:

Run the Sea King control program on the same computer as HYPACK/HYSWEEP to avoid timing problems. The serial connection is through a loop-back cable.

TSS 335

HYSWEEP driver for the TSS 335B heave compensator. Provides heave, pitch and roll data.

Connection:

RS232 Serial interface, message format:

```
:xxxxxx shhhhfrrrr spppp<cr><lf>  
zzz|zzzzzz|zz|zz|zzzzzz|  
zzz|zzzzzz|zz|zz|zzzzzz---- signed pitch in degrees * 100  
zzz|zzzzzz|zz|zz----- signed roll in degrees * 100  
zzz|zzzzzz|zz----- ? = bad heave  
zzz|zzzzzz----- signed heave in cm  
----- don't care
```

```
:xxxxxx shhhhfrrrr spppp<cr><lf>
```

Where:

:xxxxxx: signed heave in cm

shhhhf: Bad heave?

rrrr: signed roll in degrees * 100

spppp: signed pitch in degrees * 100

Offsets:

- **Starboard**: MRU location starboard of **boat center**.
- **Forward**: MRU location forward of **boat center**.
- **Vertical**: MRU location relative to waterline (positive below).
- **Yaw**: Enter 0.
- **Pitch, Roll**: Enter 0 (MRU pitch/roll offsets are typically zeroed within the MRU itself).
- **Latency**: Enter 335B latency (0 if prediction mode, 0.07 seconds if not).

Notes:

- If users want the option to record remote heave, they need to select the DMS or POS/MV driver instead of the 335B driver (see below).

TSS DMS

HYSWEEP driver for the TSS DMS/05, /10, etc. heave compensator. Provides heave, pitch and roll data.

Setup Form:



Select TSS 1 Message for the text output message – heave, pitch and roll string similar to the DMS/05.

Select TSS 3 Message to record remote heave instead of total heave as with the TSS1 message.

Select Simrad EM1000 Message for binary output containing heave, pitch, roll *and* heading.

Connection:

RS232 Serial interface, message format:

```
:xxxxxx shhhhsrrrr spppp<cr><lf>
```

```
|   | | |   |  
|   | | |   ---- signed pitch in degrees * 100  
|   | | ----- signed roll in degrees * 100  
|   | ----- don't care  
| ----- signed heave in cm  
----- don't care
```

Offsets:

- **Starboard:** MRU location starboard of **boat center**.
- **Forward:** MRU location forward of **boat center**.
- **Vertical:** MRU location relative to waterline (positive below).
- **Yaw:** Enter 0.
- **Pitch, Roll:** Enter 0 (MRU pitch/roll offsets are typically zeroed within the MRU itself).
- **Latency:** Enter 0.

Notes:

TSS POS/MV

HYSWEEP driver for POS/MV heave, pitch, roll and heading data.

Setup Form:



The screenshot shows a window titled "TSS Setup". At the top left is a small icon and the title "TSS Setup". Below the title bar is a checkbox labeled "Invert Pitch and Roll (Reversed Mount)". Underneath is a group box titled "DMS and POS/MV Drivers" containing three radio button options: "TSS 1 Message" (which is selected), "TSS 3 Message (Record Remote Heave Only)", and "Simrad EM1000 Message". At the bottom of the window are two buttons: "OK" and "Cancel".

Select TSS 1 Message for the text output message – heave, pitch and roll string similar to the DMS/05.

Select TSS 3 Message to record remote heave instead of total heave as with the TSS1 message.

Select Simrad EM1000 Message for binary output containing heave, pitch, roll *and* heading.

Connection:

RS232 Serial interface.

Offsets - MRU:

- **Starboard:** MRU location starboard of **boat center**.
- **Forward:** MRU location forward of **boat center**.
- **Vertical:** MRU location relative to waterline (positive below).
- **Yaw:** Enter 0.
- **Pitch, Roll:** Enter 0 (MRU pitch/roll offsets are typically zeroed within the MRU itself).
- **Latency:** Enter 0.

Offsets - Gyro:

- Enter 0 for all offsets and latency.

Notes:

Valeport SWiFT SVP & CTD

HYSWEEP driver for sound velocity data. Used for Valeport SWiFT SVP and CTD devices.

Setup Form:

In HYPACK Combined Hardware as a HYSWEEP Survey Device, under the “Connect” tab.

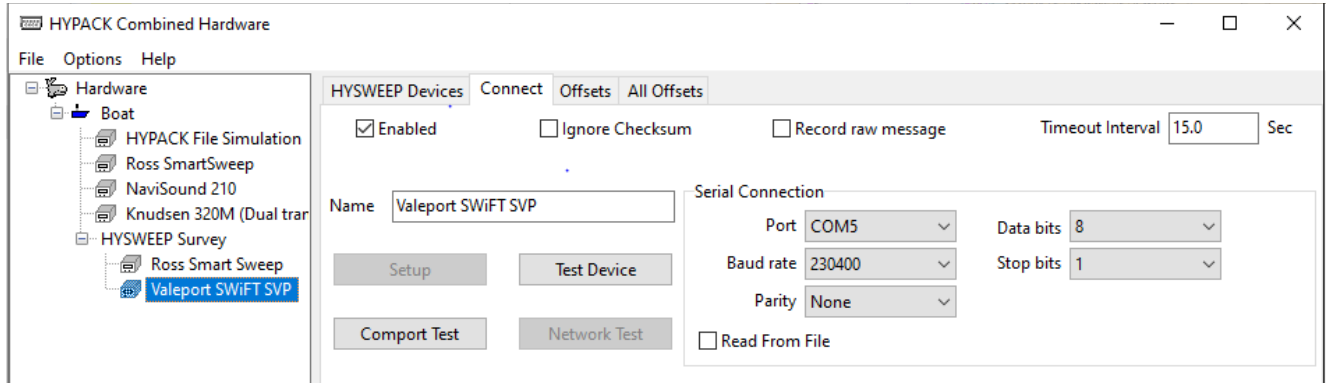

Connection:

Bluetooth or USB.

To use the Bluetooth function of the SWiFT SVP, you must use the Bluetooth USB to serial adapter on the SWiFT SVP. This will be configured using the COM port your system assigns to the Bluetooth USB device and a baud rate of 230400.

Notes:

Velodyne HDL-32E & VLP-16

High density laser device. The driver is a passive UDP network driver that reads XYZ lidar points from the data stream.

Setup Form:

None.

During survey, check the "Use TOP Message" Logging Option to log full resolution data. If this option is turned off, HYSWEEP will automatically downsample as needed.

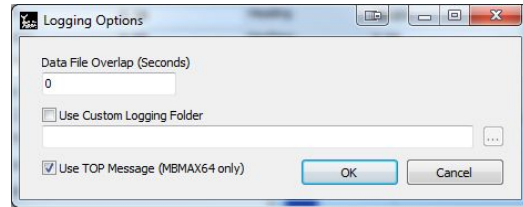

Mounting:

HYSWEEP has "vertical" and "horizontal" versions of the driver which are identical in operation except for the expected mounting. "Horizontal" assumes the device is mounted on top of the vessel with the head rotating 360° around the Z axis and the 0° point of the device aligned forward. "Vertical" assumes mounting on the stern of the vessel with the head rotating 360° around the forward (Y) axis and the 0° point of the device pointed upward.

The 0° point on the HDL-32E is 90° from the cable; on the VLP-16, it is 180° from the cable. See the following diagrams from the Velodyne user manuals:

The angle of rotation for the HDL-32E, looking down on the device from above:

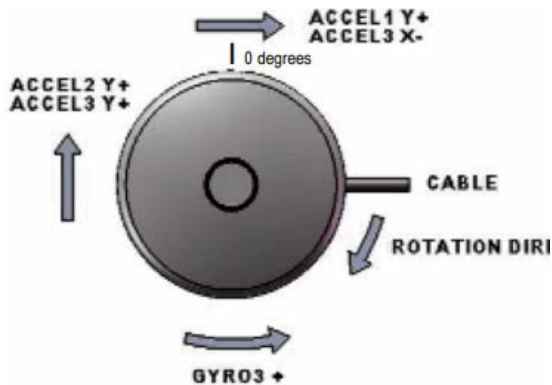

The angle of rotation for the VLP-16, looking up at the device from below:

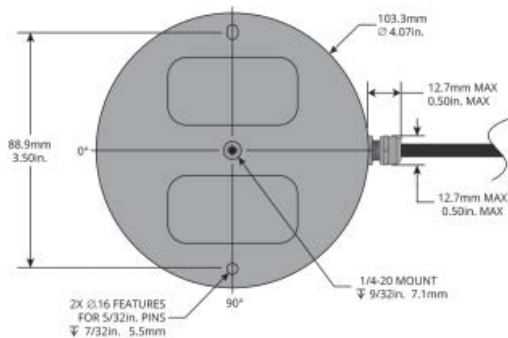

Figure 6. VLP-16 Base

Connection:

Via a network interface. Enter the IP of the device in the Connect tab. The default port is 2368.

Control Form:

The incoming point cloud can be thinned in real-time during survey with the filters provided on the HYSWEEP Velodyne controller. Note that these filters are on the HYPACK side and no commands are sent to the device. Points filtered by this method are lost--they are not displayed or logged.

We recommend disabling all but the center beam (#16) during patch testing.

Notes:

Velodyne provides a web interface to configure the head rotation speed and other parameters. Simply point a web browser to the IP address of the device.

A quality code is logged starting with HYPACK 2019, allowing filtering in MBMAX64. Codes are as follows:

- 8: Beam angle < 2 degrees
- 7: Beam angle < 4 degrees
- 6: Beam angle < 6 degrees
- 5: Beam angle < 8 degrees
- 4: Beam angle < 10 degrees
- 3: Beam angle < 12 degrees
- 2: Beam angle < 14 degrees
- 1: Beam angle >= 14 degrees
- 0: Reserved for no data or bad data

Beam angle is in the laser frame, not relative to vertical or horizontal.

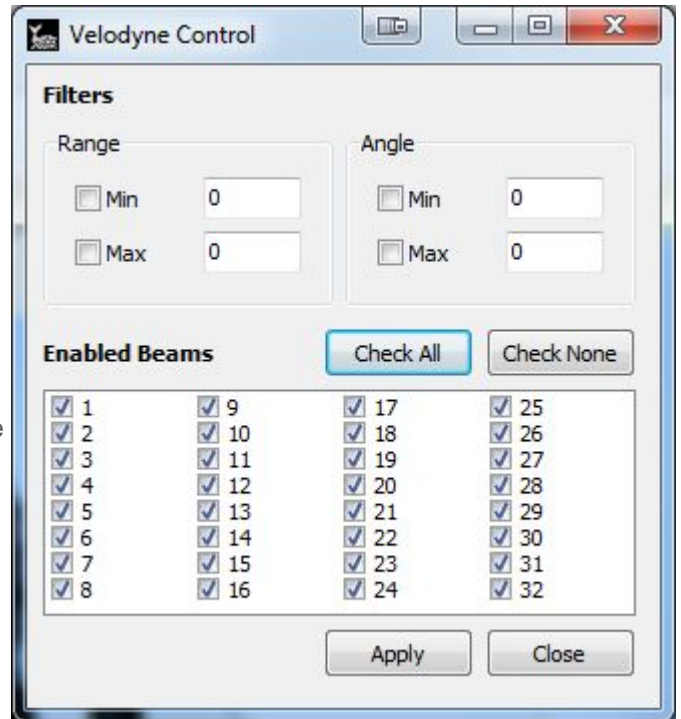

WASSP Multibeam

Simple HYSWEEP driver for the WASSP Multibeam. Reads multibeam, gyro, and MRU data from a network data stream. Works with WASSP Multibeam G2 BTXR 3250 and G3 DRX.

Setup Form:

Connection:

Via a network interface.

To connect the WASSP DRX driver to the DRX RPM module in DataManager.

Port 55555 must be used:

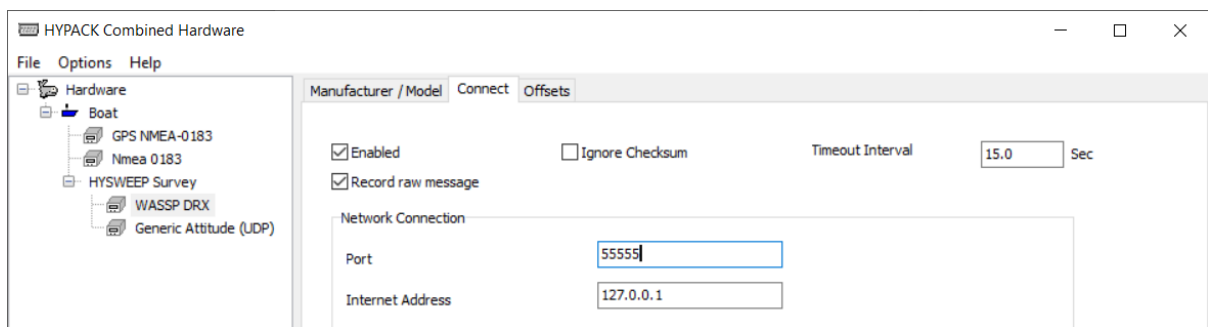

Sensor data Pass Through:

In the adapter settings enable NMEA pass-through pass through all raw serial data from sensors connected to the DRX received by the WASSP DRX Hypack adapter over a local UDP stream. (All data not limited to NMEA)

All other Hypack drivers can now use the sensor data from the DRX via the UDP port set.

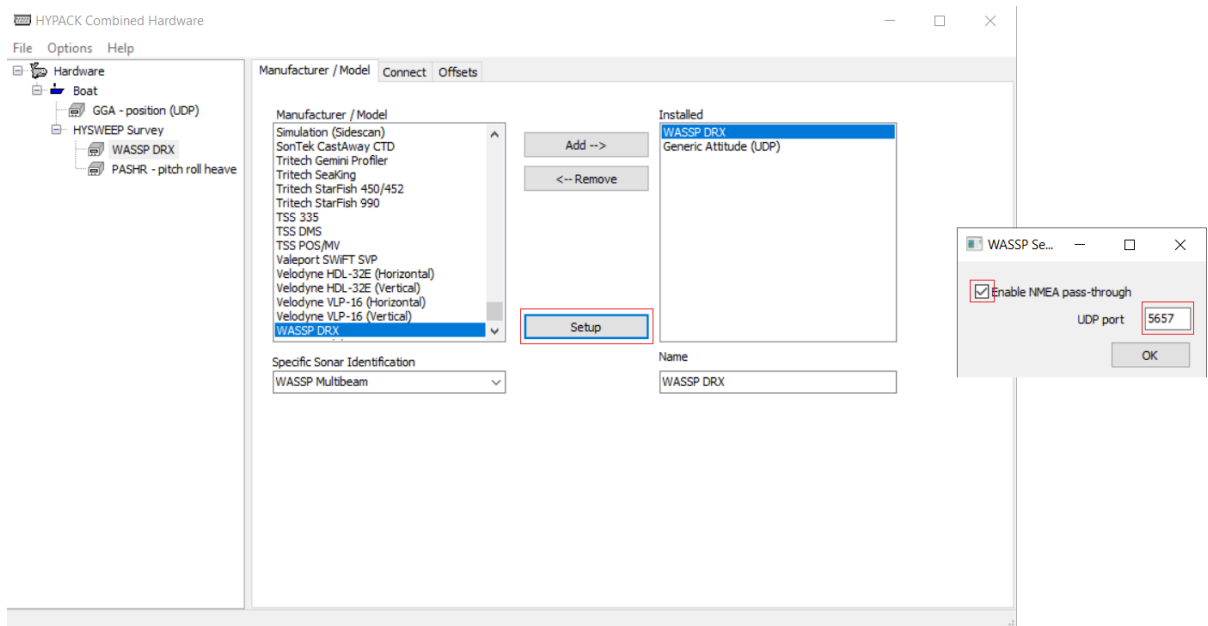

In Hypack configure a GPS (GPS.dll) and set it up for a network connection with the same port as set in the NMEA Pass through in the WASSP driver:

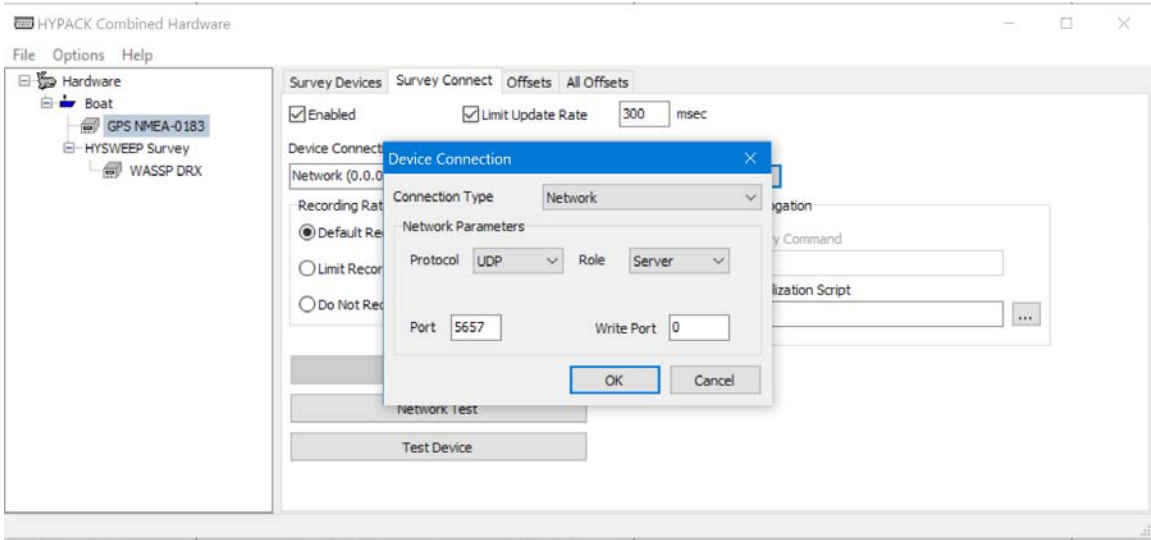

Notes:

The DRX requires PPS with ZDA for time synchronization, Position, heading, motion sensors to be connected and will be passed to Hypack over the network stream. Hysweep only requires the network stream from the DRX, no additional serial connections or time synchronisation required to the PC.

Setup RPM Data Manager

RPM is a licensed module for enhanced performance and higher ping rate. It requires to run DataManager in the background.

When running on the same PC the IP to connect to in Hypack is 127.0.0.1 port 55555

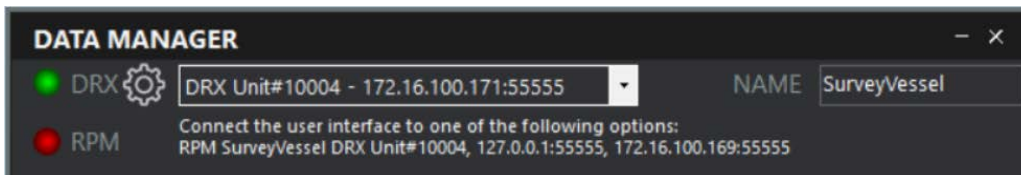

When Hysweep is connected to DataManager the RPM LED becomes green

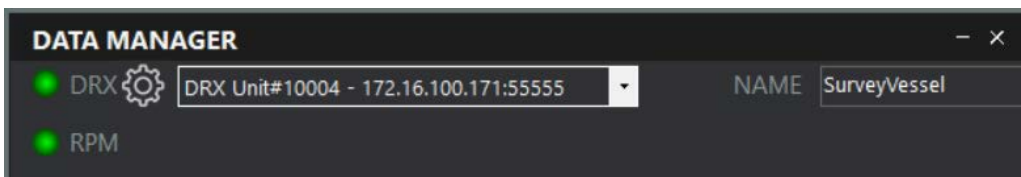

Setup DRX

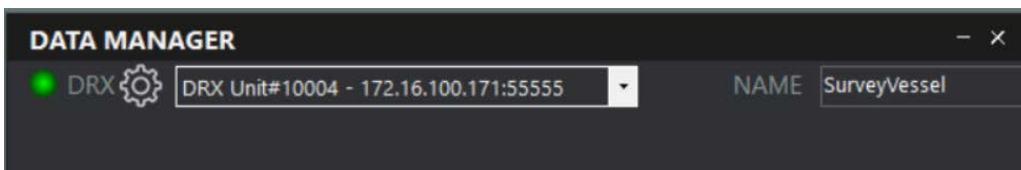

Connecting directly to the DRX in this example; IP to connect to Hypack is 172.16.100.171 port 55555

In this mode all the processing is done on the DRX and there is no need to run DataManager

Selecting the settings button in data manager brings up the WASSP webpages with the option to change the IP address.

IMPORTANT NOTE: When testing the connection with the WASSP, make sure it is installed on a vessel. Running the WASSP in a bucket of water will not work. The system will only output data when it detected a bottom!

Make sure the GPS is connected as well, as the WASSP will only output data when GPS data is received!

Devices in Beta Testing

The following devices are untested and undocumented. If you have interest in working together to complete the development, please contact Support@hypack.com

- 2G Robotics ULS-500
- AML BASEX2
- Output XYZI
- Quanergy M8 Beta (Horizontal)
- Quanergy M8 Beta (Vertical)
- Riegle VUX
- Trittech Gemini

Appendix A: Analog Sidescan Interfacing

Requires a multifunction I/O device for port and starboard transducer signals + trigger, a cable and a connector block. All are available for from National Instruments, along with a CD containing driver software.

National Instruments

11500 North Mopac Expressway,

Austin, TX 78795-3504

TEL: (512) 794-0100

FAX: (512) 683-9300

www.ni.com

I/O Board

For Desktop Computers: NI PCI-6023E – PCI Board.

For Notebook Computers: NI DAQ Card-6024E – PCMCIA Card

Cable

For the Desktop PCI Board: SH68-68-EP

For the Notebook PCMCIA Card: SHC-68-68-EP

Connector Block

For either: SCB-68.

To connect the three inputs – (1) port signal, (2) starboard signal, (3) trigger.

<u>Input</u>	<u>Connector Block</u>
1 Signal	68 (ACH0)
1 Ground	67 (AIGND)
2 Signal	33 (ACH1)
2 Ground	32 (AIGND)
3 Trigger	65 (ACH2)
3 Ground	64 (AIGND)
Note: The trigger wiring below is obsolete as of HYPACK version 2.12A.	
3 Signal	10 (PFI1/TRIG2)
3 Ground	9 (DGND) 11 (PFI0/TRIG1) connected to 47 (DIO3) for internal trigger test mode

Hardware / Software Installation

1. Before installing the NI-DAQ software, install the PCI-6023E board in a spare PCI slot.
2. Start the computer and cancel the New Hardware Wizard.
3. Install the NI-DAQ software from CD then restart the computer.
4. Upon restart, the PCI-6023E is automatically recognized and configured.

Appendix B: A Short List of Odd Things about HYSWEEP Interfacing

- All offsets are considered corrections, that is they are added to the raw data. All offsets **except** the MRU pitch and roll offsets. It got done that way a long time ago and it's too late to change it now.

Appendix C: Interferometry Real-Time Processing

As you may know, HYSWEEP has an internal limit of 1440 beams per ping for multibeam data. Of course, interferometry provides us many more points than that. Our task then is to intelligently reduce this data to something manageable by HYSWEEP which we accomplish through a combination of filtering and downsampling.

Below is a screenshot of the new windows added to HYSWEEP. The “Interferometry” window displays all the points before any decimation. Points flagged as bad or filtered will be colored red; good data is colored green. It will also show any filter boundaries in blue if any are enabled.

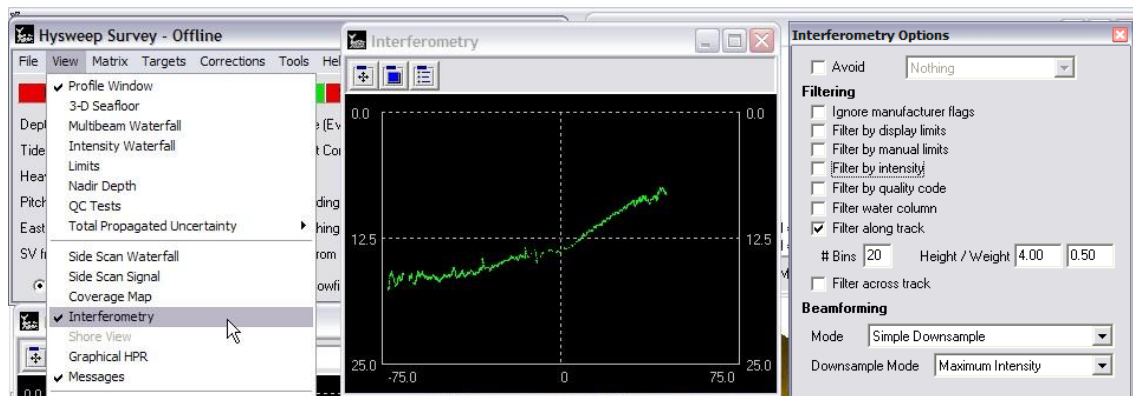

Clicking the third button on this window will open the “Interferometry Options” window. This controls how HYSWEEP will process the data. The processing chain moves from the top of the form to the bottom. Once a point is flagged, it is ignored in the rest of the chain.

Processing Options

- **Avoid.** These options allow you to skip some of the processing if the data is already sufficiently thin (ie < 1440 points). “Avoid Any Processing” will try to do nothing if it can. “Avoid Downsampling” will filter, but try not to beamform.
- **Filtering.** This section provides ways to remove noise. Typically one need not use all of these. Points can be flagged on the basis of depth, offset, intensity, or quality code. If the sonar pre-flags bad points you have the option to honor or ignore these.
- **Display limits** filters based on the depth, offset, and angle limits specified in the view options.
- **Manual limits** allows you to specify limits that are not tied to your viewing limits. You can also set your offset limits to be a multiple of water depth.
- **Intensity** and **quality code** simply filter by a specified min/max. Note that the drivers will scale intensity to a 0—32767 range and quality code to a 0—255 range. The meaning of these vary somewhat depending on the sonar.
- The **water column** filter can track a single beam echosounder depth and reject points with a range less than that value.
- The **along track** filter makes N bins across track of a specified height. Those samples falling within the bin are flagged good and affect the depth of the bin by a specified weight. The lower the weight, the slower the filter reacts to change.

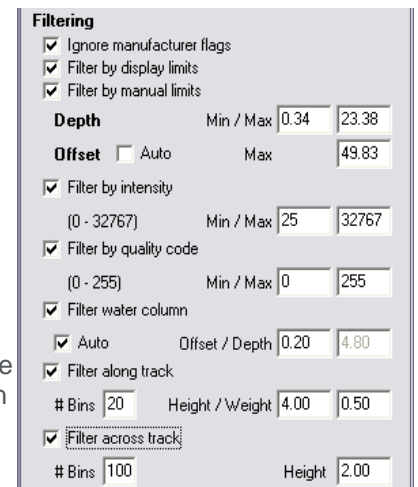
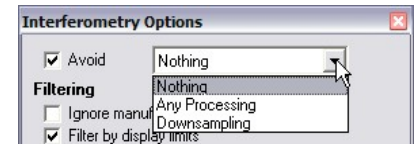

- The **across track** filter works similar to the along track, but it does not remember bin depth from ping to ping. This filter is meant to be used with the along track filter but with a smaller height.
- **Beamforming.** Two modes of beamforming are provided: simple downsampling and binning. Simple downsampling will take the results of filtering and downsample to 1440 beams. You can opt to select by intensity, quality code, or average.

The second option, binning by horizontal offset, is the method used by the GeoSwath, C3D, and SWATHplus drivers in 2009. Given a bin footprint size, it will form a beam for each bin by averaging the good points in each bin, optionally weighted by intensity or quality. In this mode, the beam quality is set to the bin point count. Also provided for this mode are standard deviation and colinearity tests which, if failed, set the beam quality to 1.

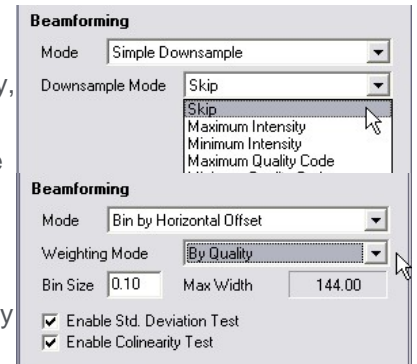

Note that these modes can be seen as opposites. In the first case, the entire swath coverage will be retained, but the beam footprint will be necessarily reduced to compensate. In the latter, footprint resolution is guaranteed at the expense of a swath width limited to $1440 * \text{bin size}$. Also, simple downsampling will retain vertical features such as quay walls while binning will average them out.

The result of this processing is what will be displayed in the rest of the HYSWEEP windows and logged to the HSX.

The Interferometry Display

The display window allows you to view the raw interferometry points and the enabled filters. In this example, the manual limits, water column, and along track filters are enabled. Manual limits and water column (if not automatically tracking a SBES depth) show handles which can be clicked and dragged to modify the filter.

The along track filter can be reseeded to the current SBES depth (or raw nadir of multibeam if no SBES) by simply turning it off and on again. However, double-clicking a point on the display will force the corresponding bin to that depth. This is handy for helping the filter “lock on” to the bottom.

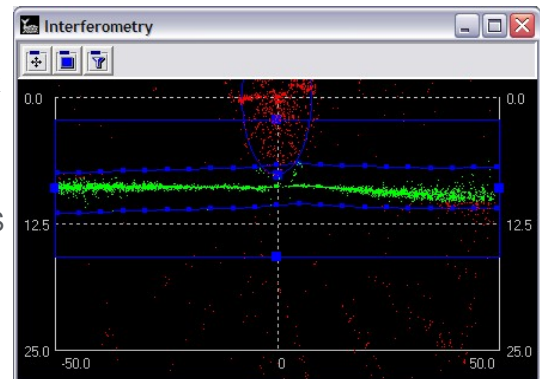

Finally, right-clicking provides a simple menu to quickly turn on/off the filters.

Appendix D: Pass Through Navigation

Starting with HYPACK 2021, HYSWEEP_Extended.DLL can be used for pass through navigation. For example, GPS data received from NORBIT sonar can be used to replace the GPS driver in HYPACK survey.

Hardware Setup

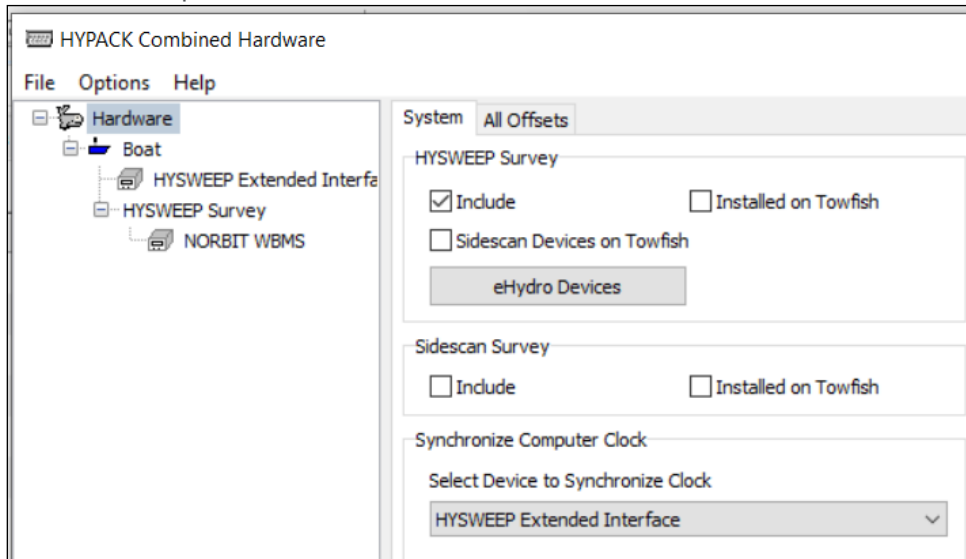

Data display in HYPACK Survey.

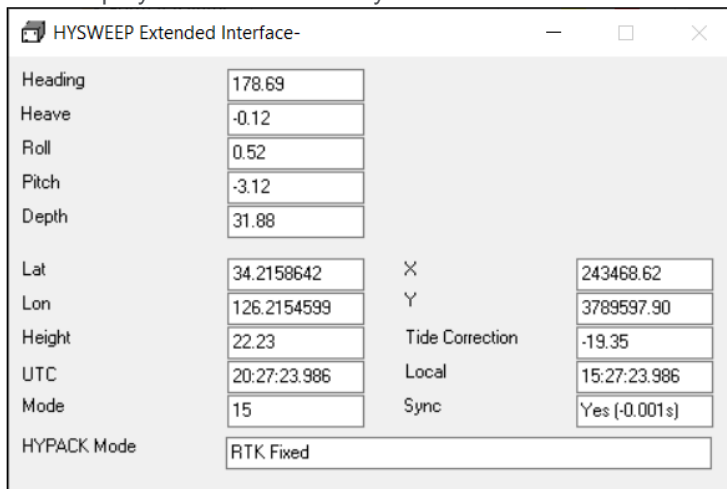

GPS info is just the basics. WGS84 latitude, longitude, height, UTC time, GPS (or inertial) mode and HYPACK standard mode. From that, XY position and RTK tides are calculated as with other HYPACK drivers. Time sync is supported, but only to +/- 10 or so milliseconds. That's OK really, because HYSWEEP devices already time tag using UTC.

Those who need navigation details and status or better time sync should not use pass through. This is primarily for simplification. Like for dredge monitoring.

Initially available for Reson and NORBIT systems (see Reson/NORBIT driver setup for pass through settings).

Appendix E: HYSWEEP with EM2040 Firmware 5 and KMALL

Ken Aiken, October 2022

Lately we've been working with Kongsberg to improve our interfacing in HYSWEEP. This has been very helpful because there are a handful of configurations that can be used. Ideally, you will use one of the first two setups documented here, but for unusual requirements I will describe two other setups as well.

Universal Step One

Whether you are using K-Controller or SIS to control the device, this step will be the same. You'll want your Kongsberg Processing Unit (PU) either connected directly to your computer with an ethernet cable, or you can use a switch in between them. You'll need to change your computer's IP address of the ethernet port you are using to an address on the same subnet. For example, if your PU's address is 157.237.20.40, you'll need to go into adapter settings and change your IP address to 157.237.20.XX

Setup 1: K-Controller and HYSWEEP on a Single Computer

This is the most basic setup. It allows you to use Kongsberg's K-Controller software with HYPACK on a single computer. This is ideal if you do not wish to collect and log with any other software and saves you from purchasing a SIS 5 license.

If you want to simultaneously log KMALL datagrams in two programs, we advise you use [Setup 3](#) with HYSWEEP on a secondary computer. We do not advise logging with a second set of software on the same computer because the large amount of data sent is taxing on the computer, and you might end up with dropped packets.

K-Controller Setup

First thing is to ensure K-Controller is set up correctly. When launching K-Controller, it hides in the task tray on the bottom right of your screen. You may have to open that up to find it. Once K-Controller is open, in the dropdown box select your sounder. Then click on the wrench icon to select Network Setup. For multicast address you can use any address you like where the first number is between 224 and 239. Be sure to note the number you used, since you'll need it when setting up HYPACK. For Multicast Port the default, 6020, is fine. It'll use this number and the two above it (6020-6022), so be sure to keep these clear. The Processing Unit IP is the address of your Kongsberg PU. You may also want to enable Advanced settings so you can disable water column using the button with a half circle on it. There are other settings elsewhere in K-Controller that you may need to set up, but for HYPACK that is all. It's helpful to leave the Network Settings page open so you can see which packets are sent through what port in the Datagram Distribution Table on the bottom.

HYPACK Setup

To set things up in HYPACK first you'll need to add HYSWEEP in your hardware setup. Then under HYSWEEP add the Kongsberg KMALL device. Do not add the Kongsberg Simrad EM2040 as this will only work for older firmware (4 and older). Open the settings dialog and select UDP Multiport. Then in the Device Name box at the bottom enter the name of the device from K-

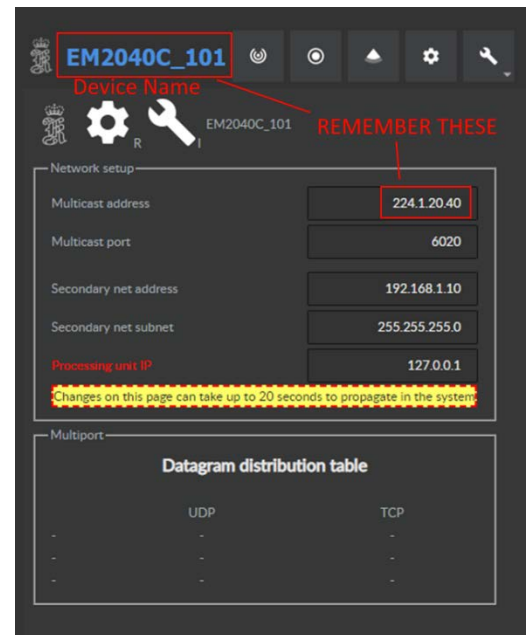

Controller. This is found in the top left of its window. Then enter the IP address of the computer in the box below it. You may also choose to Log Datagrams which will save the raw KMALL packets. You may also use TCP Multiport instead, however that will change the port number you will use in the connect tab to 13130 instead of the multicast port set in the K-Controller window. Finally switch to the Connect tab and set your port and the internet address to the Multicast Port and Address from K-Controller. You can then test to see if everything is working with the network test, however you may need to increase the port number by 2 to see anything due to the multiple ports used.

After that you should be all set. You can save your settings, close Hardware, and launch Survey and HYSWEEP. You should be able to see data coming through.

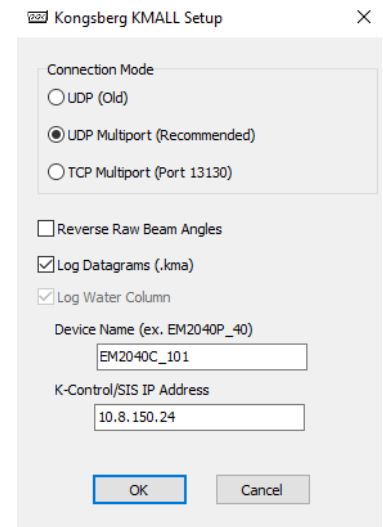

Setup 2: SIS 5 and HYSWEEP on Separate Computers with Multicasting

This is the best option to use if you have a SIS 5 license and wish to log with KMALL files. It'll also make viewing and changing your EM2040 settings easier. Again, you want to be using multiple computers for this if you are logging to KMALL to avoid dropped packets. For this setup you'll want to use a switch to connect the PU, the SIS 5 computer, and the HYPACK computer so they can all talk to each other. Then set both computers' IP address of the ethernet ports you are using to an address on the same subnet. For example, if your PU's address is 157.237.20.40, you'll need to go into adapter settings and change your IP address to 157.237.20.XX. Be sure to use something different for both computers to avoid conflicts.

SIS 5 Setup:

To set up SIS 5 for output to HYPACK, go to its network settings menu item. This will display SIS 5's built in K-Controller. Make sure multicast address is set to an address where the first number is between 224 and 239. Note the number you used - you'll need it when setting up HYPACK. For Multicast Port the default, 6020, is fine. It'll use this number and the 2 above it (6020-6022), so be sure to keep these clear. You can also see the device's name while in here on the top left, so make sure to note the name as well for HYPACK setup. You can then close this window.

HYPACK Setup:

To set things up in HYPACK, first add HYSWEEP in your hardware setup. Then under HYSWEEP, add the Kongsberg KMALL device. Do not add the Kongsberg Simrad EM2040 as this will only work for older firmware (4 and older). Open the settings dialog and select UDP Multiport. Then in the Device Name box at the bottom enter the name of the device from SIS 5. Then enter the IP address of the computer in the box below it. You may also choose to Log Datagrams which will save the raw KMALL packets. You may also use TCP Multiport instead, however that will change the port number you will use in the connect tab to 13130 instead of the multicast port from SIS 5's Network Settings window. Finally, switch to the Connect tab and set your port and the internet address to the Multicast Port and Address from K-Controller. Test to see if everything is working with the network test, however you may need to increase the port number by 2 to see anything due to the multiple ports used.

After that you should be set. You can save your settings, close Hardware, and launch Survey and HYSWEEP. You should be able to see data coming through.

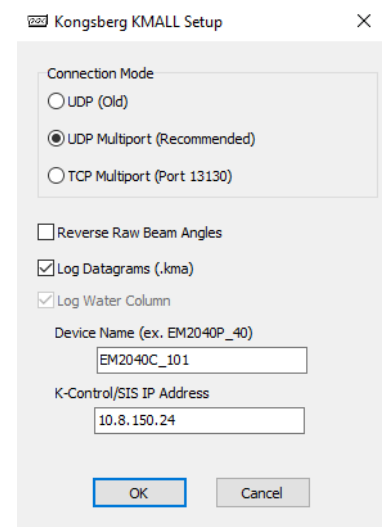

Setup 3: K-Controller and HYSWEEP on separate computers

As mentioned before, it's not recommended to have two programs logging the KMALL datagrams simultaneously, so if you have something other than SIS 5 doing logging you can set that up on the K-Controller computer and use a secondary computer to log with HYPACK. There are 2 major differences for this setup. You need to have a switch to connect both computers and the Kongsberg PU, giving them IP addresses on the same sub net as the PU. Also, when choosing the Connection Mode in HYPACK, you lose the option to choose. You must use whichever connection mode the other program is using. While the other program is connected, you look at the Datagram Distribution Table to see if it's already using TCP or UDP ports. Other than that, the instructions are the same.

Setup 4: SIS 5 and HYSWEEP on Separate Computers with Data Distributor

The Data Distributor option is helpful for some older setups that are already using this option and if you don't wish to break the existing setup if not required. For this setup, you'll still have two computers if you wish to log in SIS 5 and HYPACK. However, you could also do this locally on a single computer. Another advantage of this setup is if you don't have a switch but do have a spare ethernet port on your SIS computer, you can run the HYPACK computer through the spare ethernet port since the HYPACK computer and PU do not need to be able to communicate.

SIS 5 Setup:

In SIS 5's menu, there is a Data Distributor option. This opens a window with a table to configure specific outputs to specific ports. In here, enter the destination address and port for the HYPACK computer. You'll need to make sure to check these datagrams: IIP, IOP, MRZ, SKM, SPO, SVP and SVT. Then you should be all set.

HYPACK Setup:

To set things up in HYPACK, first you'll need to add HYSWEEP in your hardware setup. Then under HYSWEEP add the Kongsberg KMALL device. Do not add the Kongsberg Simrad EM2040 as this will only work for older firmware (4 and older). Open the settings dialog and select UDP (old). Then in the device name box at the bottom enter the name of the device from SIS 5. Then enter the IP address of the computer in the box below it. You may also choose to Log Datagrams which will save the raw KMALL packets. Finally switch to the Connect tab and set your port and the internet address to the Multicast Port and Address from K-Controller. You can then test to see if everything is working with the network test button. If you don't see anything coming through, Data Distributor may be sending packets using TCP instead of UDP. At this time I don't know how to change that so to work around that, use TCP Multiport in the device settings and use the port you specified, not the noted 13130 port.

After that you should be all set. You can save your settings, close Hardware, and launch Survey and HYSWEEP. You should be able to see data coming through.

Positioning

There are several ways you may choose to do positioning with HYPACK and your Kongsberg device, but this is one option worth noting. The Kongsberg datagram includes the positioning supplied to the PU. In your HYPACK setup, you can bring in that positioning with the HYSWEEP Extended interface. We do not recommend you use this as your primary positioning, however, it's good for QC purposes to verify that your positioning is going into and back out of the POS correctly.