

JOB:	REPRESENTATIVE:	
UNIT TAG:	ORDER NO.:	DATE:
ENGINEER:	SUBMITTED BY:	DATE:
CONTRACTOR:	APPROVED BY:	DATE:

Venturi MV2B Valve Kit

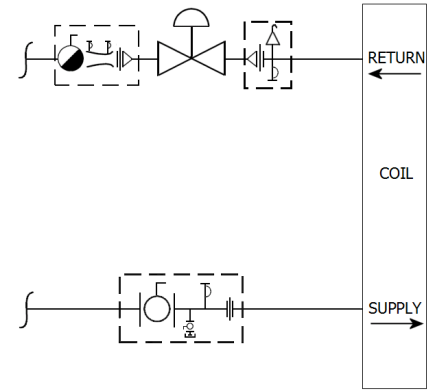
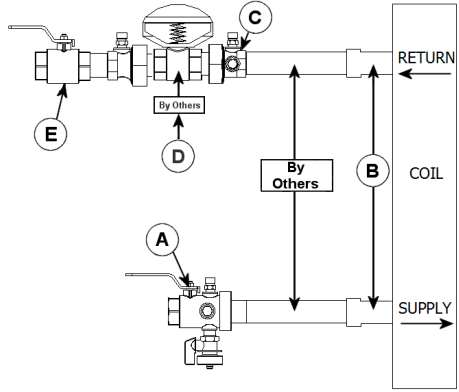

DESCRIPTION

The Bell & Gossett MV2B Valve Kit is a packaged and partially pre-assembled collection of common components required for commissioning a terminal unit. Temperature control valves, piping and coils are not supplied by B&G.

The MV2B Kit consists of:

Balloon	Part Number	Inlet Connection	Outlet Connection	Description
A				Model UBV - Combination Shut Off Valve and Union End with one Pressure / Temperature Port, Drain Valve and Tailpiece.
B				Connection Size for Coil/Terminal
C				Model UA - Union Accessory with one Pressure / Temperature Port, Manual Air Vent, Tailpiece and Union End.
D				Connection Size for Two-Way Temperature Control Valve (by others)
E				Model MV - Venturi/Ball Valve Combination - Calibrated Balance, Commissioning and Positive Shut Off Valve with two Pressure / Temperature Ports, Standard Port Ball Valve, Tailpiece and Union End.

Xylem Inc.
8200 N. Austin Avenue
Morton Grove, IL 60053
Phone: (847)966-3700
Fax: (847)965-8379
www.bellgossett.com

