



---

# Glycol Make-up Unit

---

**INSTALLER:** PLEASE LEAVE THIS MANUAL FOR THE OWNER'S USE.

---

## DESCRIPTION

Single pump unit provides pressurized water or water-glycol mixture to a closed-loop: heating, chilled water, snowmelt, and radiant heat systems. The unit is automatically controlled by a pressure switch to run at the precise pressure required.



## SAFETY INSTRUCTIONS

This safety alert symbol will be used in this manual and on the Safety Instruction decal to draw attention to safety related instructions. When used, the safety alert symbol means **ATTENTION! BECOME ALERT! YOUR SAFETY IS INVOLVED! FAILURE TO FOLLOW THE INSTRUCTION MAY RESULT IN A SAFETY HAZARD!**

# Index

---

<b>SECTION 1</b>		<b>Page</b>
1.0	General Description .....	3
1.1	Purpose of Manual .....	3
1.2	Safety .....	3
1.3	Storage .....	3
1.4	Handling .....	3
1.5	Temperature and Ventilation .....	3
1.6	Electrical Connections .....	3
1.7	Ground Connections .....	3
1.8	Power Wiring .....	3
1.9	Field Connection Diagrams .....	3
<b>SECTION 2</b>		
2.0	Installation Instructions .....	4
<b>SECTION 3</b>		
3.0	Putting the Unit into Service .....	5
3.1	Adjustments and Settings .....	5
3.1.1	Pressure Switch .....	5
3.1.2	Triple Duty Valve .....	5
3.1.2.1	Adjust Triple Duty Valve .....	5
3.1.3	Diaphragm Expansion Tank .....	5
3.1.4	Low Water Cut Off Switch .....	5
3.1.5	Sequence of Operation .....	5
<b>APPENDIX A</b>	System Piping and Unit Installation – Final Check List .....	6
<b>APPENDIX B</b>	Electrical Wiring and Control Settings – Final Check List .....	6
<b>APPENDIX C</b>	Troubleshooting .....	7
<b>APPENDIX D</b>	Typical Field Piping – IFC008 .....	8
<b>APPENDIX E</b>	Wiring Diagram – 1GMU01 .....	9

**NOTE:** The information contained in this manual is intended to assist operating personnel by providing information on the characteristics of the purchased equipment.

It does not relieve the user of the responsibility to adhere to local codes and ordinances and the use of accepted practices in the installation, operation and maintenance of this equipment.

Further information pertaining to the installation, operation, and maintenance of your Glycol Make-up System can be found in the Installation Operation and Maintenance manuals for the associated equipment provided:

- A. Bell & Gossett 3530 Pump – <http://fhasapp.ittind.com/literature/files/644.pdf>
- B. Goulds HMS Pump – <http://www.goulds.com/pdf/IM083R02.pdf>
- C. Bell & Gossett Expansion Tank – <http://fhasapp.ittind.com/literature/files/927.pdf>
- D. McDonnell & Miller Low Water Cut-Offs Switch – <http://fhasapp.ittind.com/literature/files/1446.pdf>
- E. SQUARE D Pressure Switch – <http://ecatalog.squared.com/pubs/Machine%20Control/Condition%20Sensors/Pressure%20Switches,%20Water%20and%20Air/9013F/65013-005-39F.pdf>

# Section 1

## 1.0 GENERAL DESCRIPTION

The Glycol Make-up unit is designed to automatically maintain minimum pressure in closed-loop systems. The GMU-30 uses 1/2 HP pump for systems requiring up to 30-psi. The GMU-60 uses 3/4 HP pump and for systems requiring up to 60-psi.

Depending upon the system pressure required, a GMU-30 or GMU-60 is used. In both units, a pressure switch starts and stops the pump(s).

## 1.1 PURPOSE OF MANUAL

This manual is furnished to acquaint you with some of the practical ways to install, operate, and maintain this unit. Read it completely before doing any work on your unit and keep it handy for future reference.

Equipment cannot operate well without proper care. To keep this unit at top efficiency, follow the recommended installation and servicing procedure outlined in this manual.

## 1.2 SAFETY INSTRUCTION

This safety alert symbol will be used in this manual and on the unit safety instruction to draw attention to safety related instructions. When used the safety alert symbol means **ATTENTION BECOME ALERT! YOUR SAFETY IS INVOLVED! FAILURE TO FOLLOW THIS INSTRUCTION MAY RESULT IN A SAFETY HAZARD.**

### ADDITIONAL SAFETY REQUIREMENTS

 **WARNING:** Electrical shock hazard. Inspect all electrical connections prior to powering the unit. Wiring connections must be made by a qualified electrician in accordance with all applicable codes, ordinances, and good practice. **FAILURE TO FOLLOW THESE INSTRUCTIONS COULD RESULT IN SERIOUS PERSONAL INJURY, DEATH, AND/OR PROPERTY DAMAGE.**

 **WARNING:** Prevent electrical shocks. Disconnect the power supply before beginning installation. **FAILURE TO FOLLOW THESE INSTRUCTIONS COULD RESULT IN SERIOUS PERSONAL INJURY, DEATH, AND/OR PROPERTY DAMAGE.**

Always use accurate test meters when checking electrical components. Always work with another person in case of emergency.

## 1.3 STORAGE

For long periods of storage, the unit should be covered to prevent corrosion and contamination from dirt. It should be STORED in a clean, dry location between 0 and 170°F. The relative humidity should not exceed 85%. The unit should be checked periodically to ensure that no condensation has formed. After storage, again check that it is dry before applying power.

## 1.4 HANDLING

Care should be taken to prevent damage due to dropping or jolting when moving the Glycol Make-up Unit. Transportation damage should be brought to the carrier's attention immediately upon receipt.

## 1.5 TEMPERATURE AND VENTILATION

All electrical equipment is susceptible to failure if operated in ambient temperatures outside of its rating. The OPERATING temperature range for this unit is 32 to 105°F. The relative humidity should not exceed 95% non-condensing. The unit should not be operated outside these extremes.

## 1.6 ELECTRICAL CONNECTIONS - A.C. POWER & SIGNALS INPUT VOLTAGE

The input voltage tolerance is +10/-10% of nameplate voltage.

## 1.7 GROUND CONNECTIONS

A grounding terminal is provided for a dedicated ground wire connection. All provisions of the National Electrical Code and local codes must be followed.

 **WARNING:** Conduit grounds are not adequate. A separate ground wire must be attached to the ground lug provided in the enclosure to avoid potential safety hazards. **FAILURE TO FOLLOW THESE INSTRUCTIONS CAN RESULT IN SERIOUS PERSONAL INJURY, DEATH, AND/OR PROPERTY DAMAGE.**

## 1.8 POWER WIRING

Power wire types and sizes must be selected based upon conformance with the National Electrical Code and all local codes and restrictions. In addition, only copper (Cu) wire rated for at least 75°C may be used for the power connections. Refer to the input current as listed on the motor nameplate when sizing wire. Connect the input power to the screw terminals on the Power Distribution Block labeled "L1" & "L2". Connect a ground conductor to the ground terminal attached to the Power Distribution Block. See wiring diagram 1GMU01 on page 9.

## 1.9 FIELD CONNECTION DIAGRAMS

The following field connection diagrams should be reviewed prior to unit installation and operation.

Drawing #	Description	Page
1FC008	Typical Field piping	8
1GMU01	Wiring Diagram	9

# Section 2

## 2.0 INSTALLATION INSTRUCTIONS

Locate the Glycol Make-up unit for ease of inspection, maintenance, and service. For Glycol application secondary containment is required to catch any leaks or spills that could go down the drain or out a door and cause a risk to the environment. Refer to local codes for clarification.

**FAILURE TO FOLLOW THESE INSTRUCTIONS COULD RESULT IN SERIOUS PERSONAL INJURY, DEATH, AND/OR PROPERTY DAMAGE.**

Place the unit preferably on a concrete floor or base. Level the steel base, on which the pump is mounted, in both directions by placing steel shims between the base and the anchor bolts.

 **DANGER:** Do not lift entire unit by any components lift eyebolts. Lift the unit with slings placed under the unit base rails. **FAILURE TO FOLLOW THESE INSTRUCTIONS COULD RESULT IN SERIOUS PERSONAL INJURY, DEATH, AND/OR PROPERTY DAMAGE.**

 **DANGER:** Top of unit is heavy when it is full of fluids and may tip if not lifted properly. **FAILURE TO FOLLOW THESE INSTRUCTIONS COULD RESULT IN SERIOUS PERSONAL INJURY, DEATH, AND/OR PROPERTY DAMAGE.**

 **DANGER:** Do not step on the top of the unit. It is not designed to support the weight of a person. Any fall can be serious, and may result in painful or incapacitating injury. **FAILURE TO FOLLOW THESE INSTRUCTIONS COULD RESULT IN SERIOUS PERSONAL INJURY, DEATH, AND/OR PROPERTY DAMAGE.**

A well-leveled and secured unit will result in quiet operation as well as longevity of service.

See drawing 1FC008 for general piping requirements. When connecting the GMU discharge line to the make-up line of the Closed-loop system the 3/4" NPT fitting needs to be tightened. When doing this, be sure to use a back-up wrench on the fitting. Do not over tighten the fitting. Inspect all visible fittings for leaks. Tighten the fittings if any leaks are found. Be sure to use two wrenches one to tighten the fitting and the other to back-up the fitting. Using just one wrench may damage the fitting. Never tighten a fitting while there is hydraulic pressure in the fitting.

Support the discharge line independently by use of pipe hangers or anchors. Do not attempt to spring the discharge line into position. It is recommended that there is a three (3) valve by-pass in the make-up line. See drawing 1FC008 for location of valves.

**IMPORTANT:** Do not install and operate pumps in closed systems unless the system is constructed with properly sized safety devices and control devices. Such devices include the use of properly sized and located pressure relief valves, compression tanks, pressure controls, temperature controls and flow controls as appropriate. If the package includes

a pressure relief valve, make sure the discharge of the valve is directed to the floor drain before making the unit operational.

 **WARNING:** The heating of water and other fluids causes volumetric expansion. The associated forces may cause failure of system components and release of high temperature fluids. This will be prevented by installing properly sized and located pressure relief valves and compression tanks. **FAILURE TO FOLLOW THESE INSTRUCTIONS COULD RESULT IN SERIOUS PERSONAL INJURY, DEATH, AND/OR PROPERTY DAMAGE.**

**IMPORTANT:** If vibration eliminators are used, note that unless the piping to which the vibration eliminators are connected to are properly anchored to the floor, the benefits may not be fully realized.

 **WARNING:** Electrical shock hazard. Inspect all electrical connections prior to powering the unit. Wiring connections must be made by a qualified electrician in accordance with all applicable codes, ordinances, and good practice. **FAILURE TO FOLLOW THESE INSTRUCTIONS COULD RESULT IN SERIOUS PERSONAL INJURY, DEATH, AND/OR PROPERTY DAMAGE.**

The power supply required for the unit is indicated on the nameplate located inside the control panel. A dedicated ground wire must be connected to the unit.

 **WARNING:** Conduit grounds are not adequate. A separate ground wire must be attached to the ground lug provided in the enclosure to avoid potential safety hazards. **FAILURE TO FOLLOW THESE INSTRUCTIONS CAN RESULT IN SERIOUS PERSONAL INJURY, DEATH, AND/OR PROPERTY DAMAGE.**

Single phase motors have internal overload protection. The disconnecting means and short circuit protection are to be supplied and mounted by others. Single phase panel remains fully energized at all times, unless incoming power is disconnected. Do not use the "POWER ON" light as a method to determine when the control panel is de-energized.

 **WARNING:** Electrical shock hazard. Turn off and lockout all power sources prior to servicing panel. **FAILURE TO FOLLOW THESE INSTRUCTIONS COULD RESULT IN SERIOUS PERSONAL INJURY, DEATH, AND/OR PROPERTY DAMAGE.**

 **CAUTION:** Seal damage may occur. Do not run pump dry. fill and vent the pump volute prior to operation. **FAILURE TO FOLLOW THESE INSTRUCTIONS COULD RESULT IN PROPERTY DAMAGE AND/OR MODERATE PERSONAL INJURY.**

# Section 3

## 3.0 PUTTING THE UNIT INTO SERVICE

**CAUTION:** Prevent subsequent damage. A unit showing symptoms of possible problems (noise, leaks, vibration, and/or continual operation) must be corrected immediately. **FAILURE TO FOLLOW THESE INSTRUCTIONS COULD RESULT IN PROPERTY DAMAGE AND/OR MODERATE PERSONAL INJURY.**

GMU30 is designed for systems requiring up to 30-psi, drawing water or water-glycol mixture up to 10-gpm from the 55-gallon tank and automatically servicing the closed-loop system.

GMU60 is designed for systems requiring up to 60-psi, drawing water or water-glycol mixture up to 5-gpm from the 55-gallon tank and automatically servicing the closed-loop system.

When pressure in the closed-loop system decreases to the cut-in pressure the pump will start. The pump runs until the pressure switch reaches the cut-out pressure. The pressure switch factory default cut-in setting for GMU-30 is 5-psi, and the cut-out setting is 21-psi. The pressure switch factory default cut-in setting for GMU-60 is 30-psi, and cut-out setting is 50-psi.

### 3.1 ADJUSTMENTS AND SETTINGS

#### 3.1.1 Pressure Switch

Electrical equipment should be serviced only by qualified electrical maintenance personnel.

**WARNING:** Electrical shock hazard. Single phase or three phase AC power. Disconnect and lockout power before servicing unit. **FAILURE TO FOLLOW THESE INSTRUCTIONS COULD RESULT IN SERIOUS PERSONAL INJURY, DEATH, AND/OR PROPERTY DAMAGE.**

The pressure switch is piped to the discharge line. There are two adjusting screws located on the top of the switch control. This adjustment must be made before operating the system.

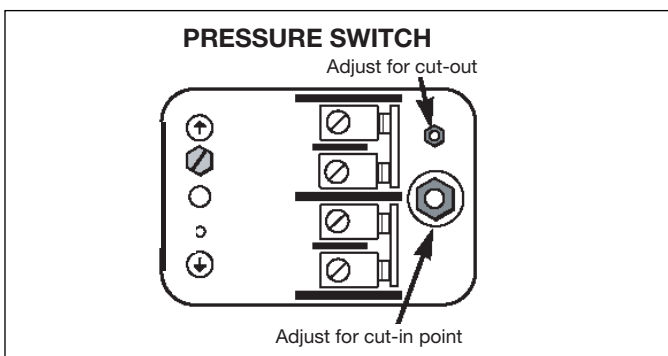

Adjust pressure switch as follows:

- Cut-In (Turn nut clockwise for higher pressure or counterclockwise for lower pressure).
- Cut-Out (Turn nut clockwise for higher pressure or counterclockwise for lower pressure).
- Check switch operation after resetting.
- See above picture for adjustment nut locations.

**WARNING:** Electrical shock hazard. Disconnect and lockout power before servicing the unit. **FAILURE TO FOLLOW THESE INSTRUCTIONS COULD RESULT IN SERIOUS PERSONAL INJURY, DEATH, AND/OR PROPERTY DAMAGE.**

#### 3.1.2 Triple Duty Valve

The Triple Duty Valve is piped to the discharge of the pump and is used as a non-slam check valve, calibrated balance valve and shutoff valve for this unit. The valve stem is located on the top of the valve. The Triple Duty Valve has a calibrated nameplate on the valve stem for rough system balance and position indication. Prior to placing GMU into operation, installer must adjust the Triple Duty Valve.

**WARNING:** Setting the Triple Duty Valve in excess of 100% open within the range labeled gravity flow can allow backward flow of glycol into the 55-gallon tank and overflow it. Adjustment must be made before placing the unit into operation. Follow the instructions that are supplied with the unit. **FAILURE TO FOLLOW THESE INSTRUCTIONS COULD RESULT IN PROPERTY DAMAGE AND/OR MODERATE PERSONAL INJURY.**

##### 3.1.2.1 Adjust Triple Duty Valve

- Never turn the valve stem in excess of 100% open when system is pressured. At this position the valve does not act as a check valve. It is a gravity flow valve.
- Never turn the valve stem to the closed position when operating the system. This position provides positive shutoff.
- Adjust the valve between 20% to 100% open.

##### 3.1.3 Diaphragm Expansion Tank

Diaphragm expansion tank factory pre-charge is 40-psi. Adjust pre-charge to equal incoming pressure. Refer to the specific IOM #V58303 that was shipped with the tank for installation and operating instructions.

##### 3.1.4 Low Water Cut Off Switch

When the water or water-glycol mixture in the 55-gallon reservoir falls below the low level point, the low water cut-off switch will turn the pump off. An alarm light will illuminate.

##### 3.1.5 Sequence of Operation

When pressure in the system decreases to the minimum allowable fill pressure, the pressure reducing valve opens.

The Glycol stored in the pressure tank flows to the system, when pressure supplied to the pressure reducing valve reaches the pump cut-in pressure, the GMU pump will start.

Pump runs until pressure switch reaches the cut-out pressure.

Should the Glycol solution in the 55-gallon reservoir fall below the low level point in the reservoir, the low level switch will turn pump off, an alarm light will be signaled.

# Appendix A

## SYSTEM PIPING AND UNIT INSTALLATION – FINAL CHECK LIST

- \_\_\_ 1. Is the unit base properly leveled and secured?
- \_\_\_ 2. Are all lubrication points properly lubricated?
- \_\_\_ 3. Is the shut-off valve to the pump suction open?
- \_\_\_ 4. Is the shutoff valve to the Diaphragm Expansion Tank line open?
- \_\_\_ 5. Are the shutoff valves for the make-up line open?
- \_\_\_ 6. Is the Triple Duty Valve turned to suitable operating position?
- \_\_\_ 7. Is the piping properly supported to prevent strains on unit?
- \_\_\_ 8. Is the system, including the pumps, purged of debris and air?

 **CAUTION:** Seal damage may occur. Do not run pumps dry. Fill and vent the pump volute prior to operation. **FAILURE TO FOLLOW THESE INSTRUCTIONS COULD RESULT IN PROPERTY DAMAGE AND/OR MODERATE PERSONAL INJURY.**

# Appendix B

## ELECTRICAL WIRING AND CONTROL SETTINGS – FINAL CHECK LIST

- \_\_\_ 1. Does the feeder line voltage correspond to the unit voltage? Check the unit nameplate or motor terminal connection.

 **WARNING:** Electrical shock hazard. Inspect all electrical connections prior to powering the unit. Wiring connections must be made by a qualified electrician in accordance with all applicable codes, ordinances, and good practices. **FAILURE TO FOLLOW THESE INSTRUCTIONS COULD RESULT IN SERIOUS PERSONAL INJURY, DEATH, AND/OR PROPERTY DAMAGE.**

- \_\_\_ 2. Are the feeder wires correctly sized for the load?

 **WARNING:** Conduit grounds are not adequate. A separate ground wire must be attached to the ground lug provided in the enclosure to avoid potential safety hazards. **FAILURE TO FOLLOW THESE INSTRUCTIONS COULD RESULT IN SERIOUS PERSONAL INJURY, DEATH, AND/OR PROPERTY DAMAGE.**

- \_\_\_ 3. Have all the power terminals in the control panel been checked for tightness? This is imperative since stranded wires tend to “flow” and become loose after initial installation.

 **WARNING:** Electrical shock hazard. Single phase or three phase AC power. Disconnect and lockout power before servicing unit. **FAILURE TO FOLLOW THESE INSTRUCTIONS COULD RESULT IN SERIOUS PERSONAL INJURY, DEATH, AND/OR PROPERTY DAMAGE.**

- \_\_\_ 4. Are the pressure controls correctly set? The pressure switch needs to be set for proper operation. Any subsequent change in system operating conditions may require resetting the controls. For best results, use compressed air and a continuity meter (across the switch) to reset the controls. The legend plate on the control indicates approximate readings only, therefore, should be used with caution.

# Appendix C – Troubleshooting

 **DANGER:** Troubleshooting live control panels exposes personnel to hazardous voltages. Electrical troubleshooting must only be done by a qualified electrician. **FAILURE TO FOLLOW THESE INSTRUCTIONS COULD RESULT IN SERIOUS PERSONAL INJURY, DEATH, AND/OR PROPERTY DAMAGE.**

## **Pump will not operate:**

- 1) Check incoming power
- 2) Check motor overload. Reset if tripped.
- 3) With contactor pulled in, check voltage of the motor leads. Voltage should be the same as the incoming power. If no voltage is present, replace the contactor. If voltage is present, contact an electrician to check the leads & motor.
- 4) Check pressure switch cut-in and cut-out setting.
- 5) Check low water cut-off switch probe point in the reservoir.

## **Pump will not build pressure**

- 1) Suction valve is closed. If closed, open.

 **DANGER:** High voltage can kill. Disconnect and lockout power prior to servicing unit. **FAILURE TO FOLLOW THESE INSTRUCTIONS COULD RESULT IN SERIOUS PERSONAL INJURY, DEATH, AND/OR PROPERTY DAMAGE.**

- 2) Motor not operating at rated RPM. Have motor checked at local motor repair shop.
- 3) Internal pump damage. Take pump to authorized pump repair facility.

## **Pump will not start automatically**

 **WARNING:** Electrical shock hazard. Inspect all electrical connections prior to powering the unit. Wiring connections must be made by a qualified electrician in accordance with all applicable codes, ordinances, and good practice. **FAILURE TO FOLLOW THESE INSTRUCTIONS COULD RESULT IN SERIOUS PERSONAL INJURY, DEATH, AND/OR PROPERTY DAMAGE.**

- 1) No power. Restore if there is no power.
- 2) Pressure switch not adjusted properly. Refer to pressure switch setting section 3.1.1.

# Appendix D – Typical Field Piping - IFC008

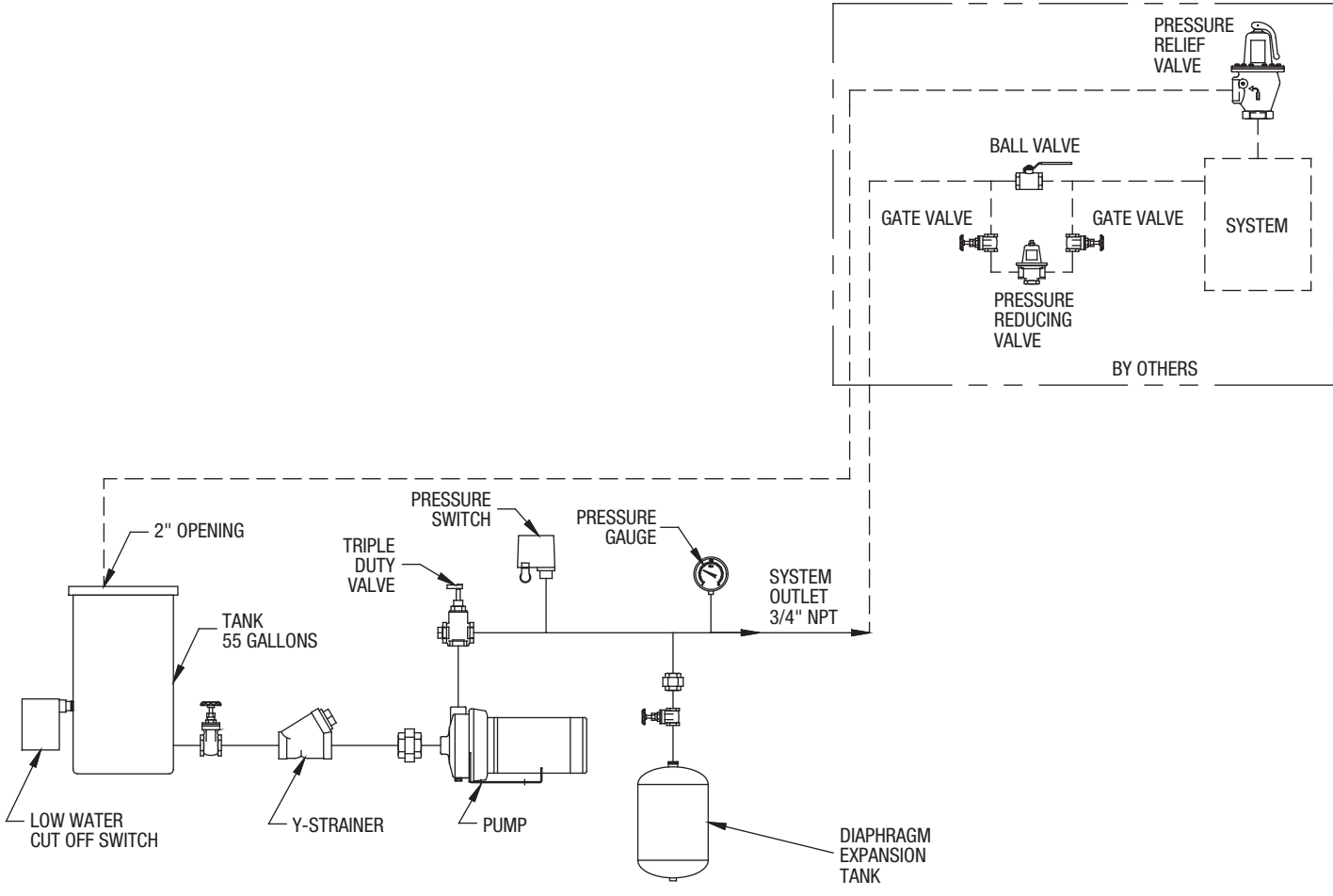



# Appendix E – Wiring Diagram - 1GMU01

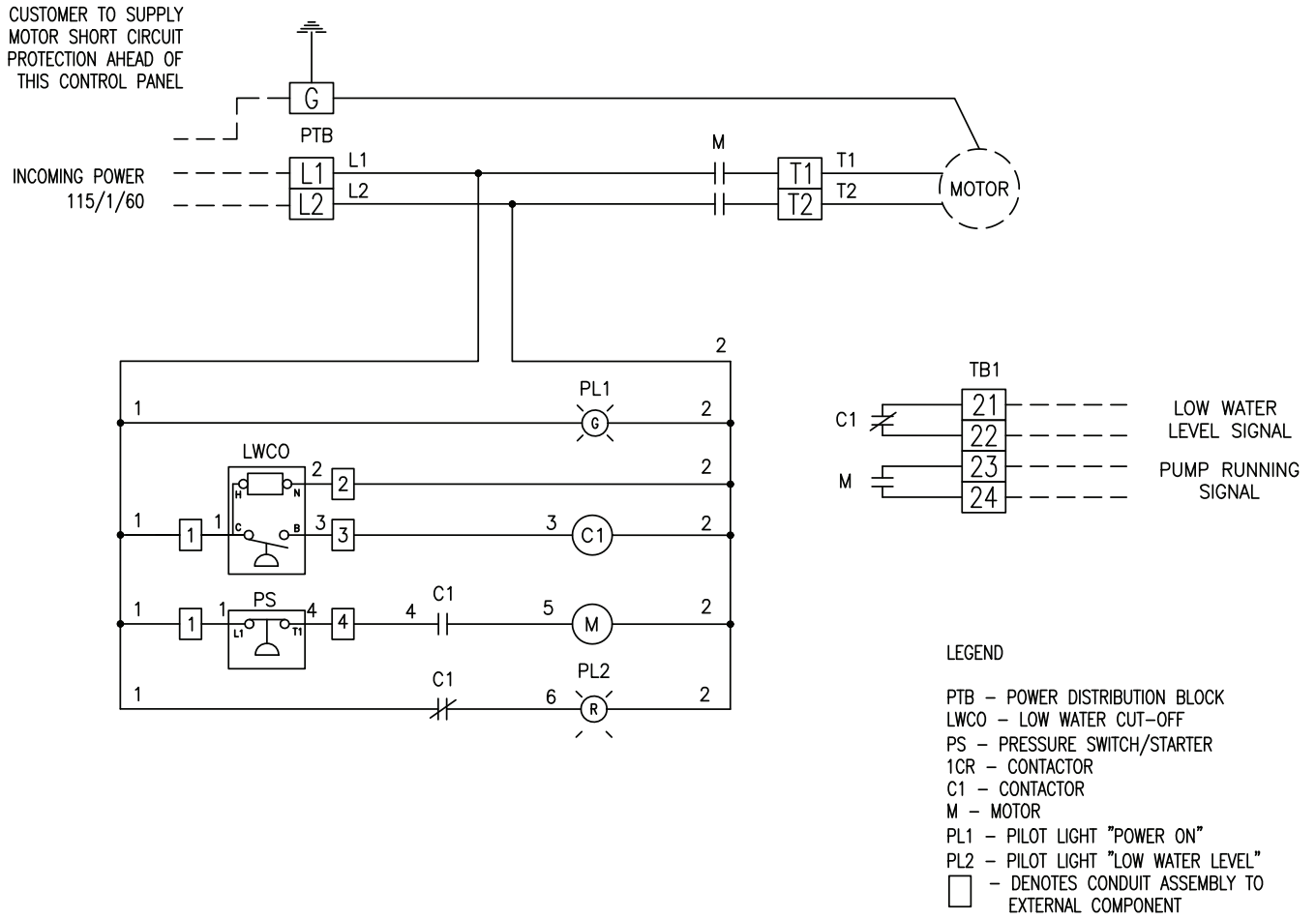

# Xylem |'zīləm|

- 1) The tissue in plants that brings water upward from the roots;
- 2) a leading global water technology company.

We're 12,500 people unified in a common purpose: creating innovative solutions to meet our world's water needs. Developing new technologies that will improve the way water is used, conserved, and re-used in the future is central to our work. We move, treat, analyze, and return water to the environment, and we help people use water efficiently, in their homes, buildings, factories and farms. In more than 150 countries, we have strong, long-standing relationships with customers who know us for our powerful combination of leading product brands and applications expertise, backed by a legacy of innovation.

**For more information on how Xylem can help you, go to [www.xyleminc.com](http://www.xyleminc.com)**



**Xylem Inc.**  
10661 Newkirk Street  
Dallas, TX 75220  
Phone: (469) 221-1200  
Fax: (214) 357-5861  
[www.xyleminc.com/brands/bellgossett](http://www.xyleminc.com/brands/bellgossett)

Bell & Gossett is a trademark of Xylem Inc. or one of its subsidiaries.  
© 2012 Xylem Inc. S14362C August 2012