

## Variable Speed NRF-VS Control with setpoint or external signal follower

**INSTALLER:** PLEASE LEAVE THIS MANUAL FOR THE OWNER'S USE.



### SAFETY INSTRUCTION

This safety alert symbol will be used in this manual and on the pump Safety Instruction decal to draw attention to safety related instructions. When used, the safety alert symbol means **ATTENTION! BECOME ALERT! YOUR SAFETY IS INVOLVED! FAILURE TO FOLLOW THESE INSTRUCTIONS MAY RESULT IN A SAFETY HAZARD.**

Your NRF-VS Control should have the warning/caution label displayed to the right (Fig. 1) on the pump conduit box. If this warning and caution label is missing or illegible, contact your local B&G Representative for a replacement.

FIG. 1

<b>⚠ WARNING</b>
BEFORE INSTALLING, USING OR SERVICING THIS PRODUCT, READ THE INSTRUCTIONS TO REDUCE RISK OF ELECTRICAL SHOCK, SEE INSTRUCTIONS FOR PROPER INSTALLATION.
<b>⚠ CAUTION</b>
FOR SUPPLY CONNECTIONS USE WIRE SUITABLE FOR AT LEAST 90°C. USE COPPER CONDUCTORS ONLY. EMPLOYER DES FILS D'ALIMENTATION ADEQUATS POUR 90°C. FOR INDOOR USE ONLY. EMPLOYER UNIQUEMENT A L'INTERIEUR.

## DESCRIPTION

The NRF-VS is a variable speed control for use in hydronic heating and cooling applications. The temperature of the water is controlled by regulating the speed of the pump which injects water from a different temperature water loop (Primary loop) into a controlled loop (Secondary loop). As the speed of the pump increases, more water is sent into the Secondary loop, resulting in a secondary loop water temperature change.

The NRF-VS can be used either to receive an external 4-20mA or 2-10V signal to control the pump speed. This allows the control to regulate the pump speed to match the input signal supplied.

The NRF-VS can also be used as a set point control. In this mode of operation, the NRF-VS will control the pump speed to hold a constant temperature (determined by the user) in the Secondary loop. The NRF-VS is capable of reading the loop temperature sensor. When used in a heating application, if the loop temperature falls below an adjustable setting, the NRF-VS will increase the speed of the injection pump.

In addition, the NRF-VS can be used in cooling applications. In this scenario, the NRF-VS will increase pump speed whenever the loop temperature increases above the setpoint.

## OPERATIONAL LIMITS

These controls are to be used on pumps designed to pump liquids compatible with their cast iron, bronze or stainless steel body constructions.

Maximum Operating Pressure: 150 PSI (10 bars).

Maximum Operating Temperature: 240°F cast iron body, 230°F brass and stainless steel body.

Electrical Rating: 115V, 60HZ, 1Ø.

Suitable for NRF, NBF, and SSF pumps with less than 1.1 amps pump nameplate rating.

## REQUIREMENTS

### ELECTRICAL SAFETY



#### WARNING: ELECTRICAL SHOCK HAZARD

Electrical connections are to be made by a qualified electrician in accordance with all applicable codes, ordinances and good practices. Failure to follow these instructions could result in serious personal injury, death and/or property damage.



#### WARNING: ELECTRICAL GROUNDING HAZARD

Adequate electrical grounding is required for the safe operation of B&G Pumps. The use of grounded metal conduit assures this requirement. If means of connection to the supply – connection box (wiring compartment) is other than grounded metal conduit, ground the pump back to the service. Use a copper conductor at least the size of the circuit connectors supplying the pump. Connect the ground wire to the green grounding screw in the wiring compartment. Failure to follow these instructions could result in serious personal injury, death and/or property damage.

## TYPICAL APPLICATIONS

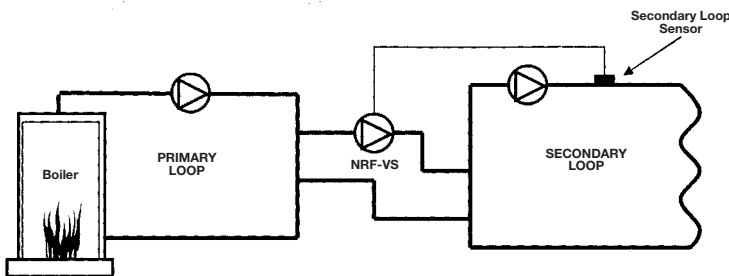

PRIMARY-SECONDARY INJECTION

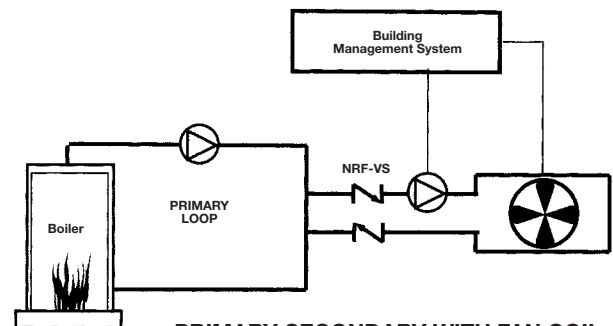

PRIMARY-SECONDARY WITH FAN COIL

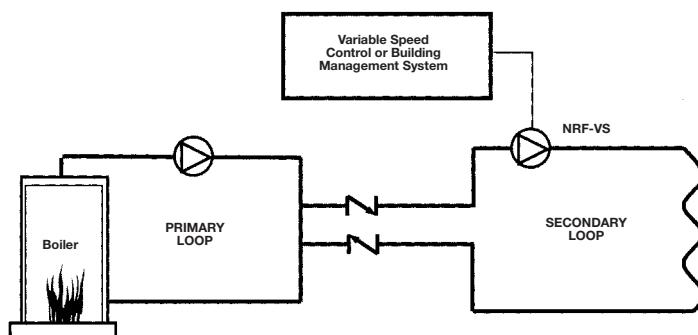

PRIMARY-SECONDARY

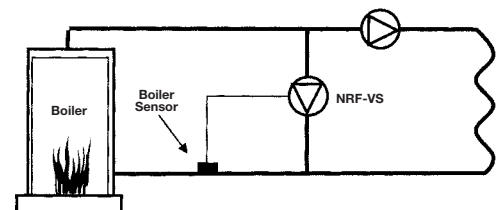

BYPASS BOILER INJECTION

## OPERATION

The NRF-VS is designed to control the pump speed on an injection system allowing the pump to inject a different water temperature into a secondary loop to regulate its temperature. It can be used either in heating or cooling applications using a secondary loop temperature sensor. The sensor reads the secondary loop temperature allowing the NRF-VS to regulate the loop temperature by modulating the injection pump speed accordingly to reach a set point.

A temperature knob mounted on the NRF-VS is used to adjust the temperature set point either in heating or cooling (see Dip Switch 2). Dip Switch 1 must be set to ON to activate the Set Point feature. The sensor must be wired to terminals 2 and 3 when using the setpoint mode.

The NRF-VS can be controlled remotely using an external signal to replace the set point. This allows for the external control or system providing the input to change the pump speed directly. No sensor is required in this setting. The external input providing either 4-20mA signal or 2-10V signal must be wired to terminals 1 and 2. The speed of the pump will vary from full stop below 4mA or 2V to 100% at 20mA or 10V. Dip switch 1 must be set OFF to activate the external signal feature.

## DESIGN SELECTION

To select the correct pump, pipe size and balance valve:

1. Determine the Primary Loop Temperature. This is the temperature the primary loop will maintain.
2. Determine the Secondary Loop Temperature. This is the design temperature of the secondary loop. If an outdoor reset function is being employed, this is the required temperature of the secondary loop under maximum load.
3. Determine the design temperature drop ( $\Delta T$  or delta T) of the secondary loop. This is the design drop in temperature through the secondary loop. In most radiant heat applications,  $\Delta T$  is 10. Other types of radiation such as baseboard have a higher design  $\Delta T$ .
4. Determine the Maximum Injection Heat Load. This is the maximum heat requirement of the secondary loop. The maximum injection heat load is based on the injection pump running at the highest speed. As the pump speed is reduced, less heat will be delivered to the secondary loop.
5. Use the equation below to determine the design injection flow rate.

$$\text{Design Injection Flow Rate (GPM)} = \frac{\text{Maximum Injection Heat Load (BTU/hr)}}{500 (T_{\text{primary}} - T_{\text{secondary}} + \Delta T_{\text{secondary}}) (^{\circ}\text{F})}$$

6. Use the table below to select the appropriate pump, pipe size and balance valve.

Design Injection Flow Rate (GPM)	Injection Pipe Size	B&G Circuit Setter® Balance Valve	B&G Circuit Setter® Valve Setting	B&G Pump
1.5	1/2"	CB-1/2 / CB-1/2S	18 / 25	NRF-22
3.5	1/2"	CB-1/2 / CB-1/2S	full open / 6	NRF-22
6	3/4"	CB-3/4 / CB-3/4S	full open / 12	NRF-22
10	1"	CB-1 / CB-1S	full open / full open	NRF-22
15	1 1/4"	CB-1 1/4 / CB-1 1/4S	5 / 5	NRF-22

Based on (5) feet of pipe, (4) 90° elbows, (4) tees. Correct pipe and pump size calculation for any application should be performed by a qualified engineer or contractor.

Example:

1. Primary Loop Temp: 140°F
2. Secondary Loop Temp: 100°F
3. Design temperature drop: 10°F
4. Maximum injection heat load: 150,000 BTU/hr
5. Calculate Injection flow rate

$$\text{Design Injection Flow Rate (GPM)} = \frac{150,000 \text{ (BTU/hr)}}{500 (140 - 100 + 10) (^{\circ}\text{F})} = \frac{150,000}{25,000} = 6 \text{ GPM}$$

6. Injection Pipe size is 3/4", full open CB-3/4 balancing valve and NRF-22

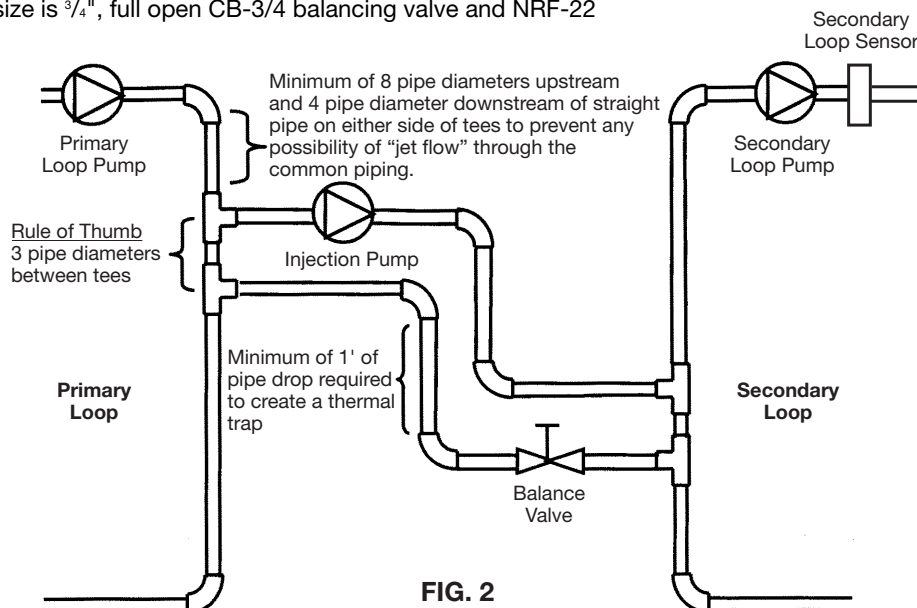

FIG. 2

## PIPING

### PIPING OVERVIEW

- The Primary loop may have multiple injection loops or other takeoffs. However, the piping for each injection system must meet the requirements described below.
- The Injection piping can be installed in either a horizontal or a vertical configuration.
- The pipe diameters of the Primary and Secondary loops may differ.
- The Injection Piping diameter must be at least one pipe size smaller than the smaller of the Primary and Secondary loop piping. For example, if the Primary loop diameter is 1 1/4" and the Secondary loop diameter is 1", then the diameter of the Injection piping must be 3/4" or smaller.

**CAUTION:** The Injection pump and pipe sizing should be performed by a qualified engineer or contractor. Failure to follow these instructions could cause inadequate system performance and/or property damage.

- The Injection pump motor must be a fractional B&G NRF, NBF or SSF permanent split capacitor type pump. (Refer to operational limits on Page 2 for pump information.) The Injection pump will control the amount of water pumped from the Primary loop into the Secondary loop.
- A balancing valve should be installed on the injection return piping. This helps to balance the system.
- The distance between the injection tees should be as short as possible. The rule of thumb distance between the tees is 3 times the pipe diameter. For instance, if the pipe diameter is 1" then the length of straight pipe between the two injection tees should be 3".

### HORIZONTAL PIPING CONFIGURATION

- The Injection piping can be installed horizontally as shown in Fig. 2.
- The Injection supply piping should run horizontally from the Primary to the Secondary loop.
- On the Injection piping it is necessary to install a heat trap to prevent heat from the Primary loop entering the Secondary loop when the Injection pump is not running.
- The injection piping must drop down vertically at least 18" and then rise back up vertically at least 18".

### VERTICAL PIPING CONFIGURATION

- The Injection piping can be installed vertically.
- The Primary loop must be at least 18" vertically above the Secondary loop.

### INSTALLING SENSOR

- In a primary/secondary application, the secondary loop sensor should be mounted downstream of the inlet loop and before any major heating units. That will provide the control a more accurate temperature reading (Refer to Fig. 2.)
- Strap the cylindrical sensor to the pipe as shown in Fig. 3.
- Wrap the pipe and sensor assembly with insulating tape to insure adequate heat transfer to the sensor.

- The sensor wires can be extended up to 500' from the controller. If the sensor wires are located in an area with strong sources of electro-magnetic interference (EMI), the wires must be run in a grounded metal conduit. Do not run wires in conduit with line voltage.

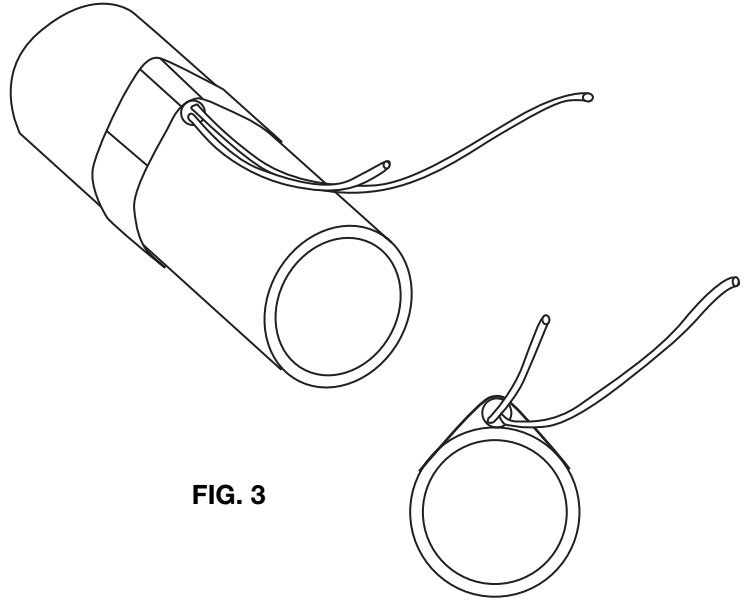

FIG. 3

### WIRING

**NOTE:** If the NRF-VS control is already installed on the pump, skip the NRF-VS control installation section and proceed to the "wiring the sensors" section.

### NRF-VS CONTROL INSTALLATION

1. Disconnect the electrical supply to the pump.

**WARNING: ELECTRICAL SHOCK HAZARD**  
Disconnect and lock out power before making electrical connections. Failure to follow these instructions could result in serious personal injury or death.

2. Remove the screw that holds the steel conduit box cover to the pump.
3. Remove the conduit box cover. The NRF-VS control assembly replaces the conduit box cover.
4. Disconnect the black and white motor leads from the power supply.
5. Position the plastic base for the NRF-VS control assembly onto the steel conduit box with the warning/caution label to the rear of the pump.
6. Secure the plastic base to the conduit box with one 8-32 screw provided.
7. Verify that the electrical rating of the NRF-VS control matches the values shown on the nameplate of the circulator.

- Make the electrical connections according to the wiring diagram provided (See Fig. 4). Route the power wiring through one of the 7/8" diameter holes in the steel conduit box. The control or sensor wiring must pass through the 7/8" diameter hole in the plastic enclosure.
- Attach 120VAC line voltage to the orange wire extending from the back of the NRF-VS. Wire the neutral wire to either of the orange wires extending from the back of the NRF-VS.



**WARNING: ELECTRICAL SHOCK HAZARD**

Electrical connections are to be made by a qualified electrician in accordance with all applicable codes, ordinances and good practices. Failure to follow these instructions could result in serious personal injury, death and/or property damage.

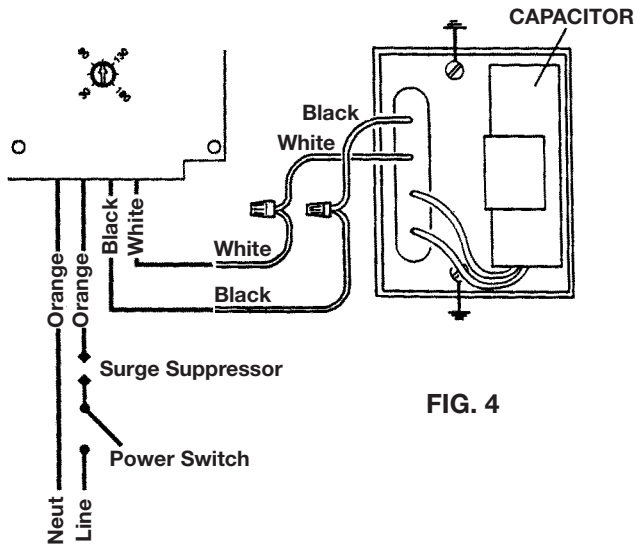

FIG. 4

**WIRING THE SENSORS FOR SETPOINT CONTROL**

- Sensor terminals are located on the back of the NRF-VS control board.
- To set the NRF-VS for use with a temperature sensor, set Dip Switch 1 to On.
- Pass the sensor wiring through the 7/8" hole in the plastic enclosure. Low voltage wiring must be separated from power wiring.
- The sensor wires have no polarity. Connect either wire from the sensor to terminals 2 and 3. (See Fig. 5)
- Sensors are typically installed on the secondary loop. (See Fig. 2)
- On a sensor failure or short the pump will run at full speed and LED Lights will blink indicating a fault status.

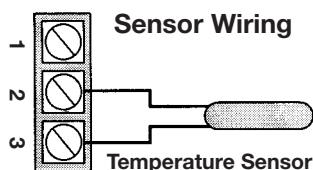

FIG. 5

**WIRING THE EXTERNAL SIGNAL INPUT 4-20mA OR 2-10V**

- External signal terminals are located on the back of the NRF-VS control board. (See Fig. 6).
- To wire the NRF-VS for use with an external signal either 4-20mA or 2-10V, set Dip Switch 1 to Off.
- The NRF-VS DOES NOT source current for the signal. The current must be supplied by the control or system supplying the signal.
- Pass the sensor wiring through the 7/8" hole in the plastic enclosure. Low voltage wiring must be separated from power wiring.
- Polarity is important when using an External Signal. Always connect the common to terminal 2 while the signal side is connected to terminal 1.
- On a signal error the pump will fully stop and LED Lights will blink indicating a fault status.
- When using 4-20mA input signal, make sure the input source can supply at least 10V.
- When using 2-10V input signal, make sure the input source can supply at least 20mA.

**External Signal Wiring**

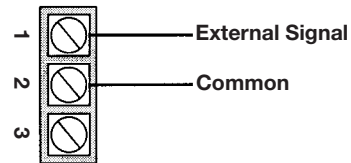
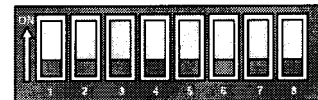

FIG. 6

**DIP SWITCH SETTINGS**

**Dip Switches**



**Dip Switch 1 (Input Mode 4-20mA/2-10V or Setpoint)**

1=Off (4-20mA/2-10V), 1=On (Setpoint) Default 1=Off

- This control can vary the pump speed based on either an External Signal of 4-20mA/2-10V or a Temperature Setpoint.

**Input Mode Setting Dip Switch 1**



### Setpoint (Dip Switch 1=On)

- The Dial on the NRF-VS allows for set point temperature adjustment. Use a small screwdriver to turn the dial so that the arrow lines up with the desired setpoint temperature.
- The pump speed will vary based on the difference between the secondary loop sensor reading and the set point on the NRF-VS.

### External Signal (Dip Switch 1=Off)

- Below 4mA or 2V, the pump will fully stop. At 20mA or 10V the pump will run at full speed.
- The temperature dial is deactivated when control is in the external signal mode.

### Dip Switch 2 (Control Mode Heating or Cooling) Available with Setpoint Only

2=Off (Heating), 2=On (Cooling)      Default 2=Off

- When Heating is selected, the control will increase pump speed when the loop temperature drops further from the Setpoint. When loop temperature is higher than the setpoint, the control will turn off the pump. Refer to the outer range of 70°-200°F shown in the scale.
- In Cooling, the control will increase pump speed the higher the loop temperature increases above the Setpoint. When the setpoint is reached and maintained, the control will turn off the pump. Refer to the inner range of 30°-100°F shown in the scale.

### Dip Switch 3 (Output Mode Linear or Logarithmic)

3=Off (Linear), 3=On (Logarithmic)      Default 3=Off

#### Linear (Dip Switch 3=Off)

Linear operation is based on a linear relationship between percent of flow of the pump and BTU output of the terminal unit. Typical application is when the pump injects into a constant circulating loop, which includes the terminal unit.

#### Logarithmic (Dip Switch 3=On)

Logarithmic operation is based on non-linear relationship between percent of flow of the pump and BTU output of the terminal unit. In order to achieve the desired linear output, the NRF-VS provides a logarithmic output to compensate for the non-linear terminal output. Typical application is when the pump injects directly into the terminal unit.

### Dip Switch 4 (Gain) Available with Setpoint Only

4=Off (Normal), 4=On (Fast)      Default 4=Off

- The Gain is how aggressive the control should behave when loop temperature is far from Setpoint. It governs the amount of change the control applies to pump speed.
- Normal gain is typically used in applications where the sensor temperature changes gradually during operation.
- Fast gain is typically used in applications where the sensor temperature changes rapidly during operation.

### Dip Switch 5 (Pump Exercise)

5=On (Exercise), 5=Off (No Exercise)      Default 5=On

- This Dip Switch regulates if the pump should be exercised when stayed idle for a long period of time. When set to Exercise, pump will run at full speed for a period of 10 seconds when left in idle status for a period of 72 hours.

### Temperature Dial

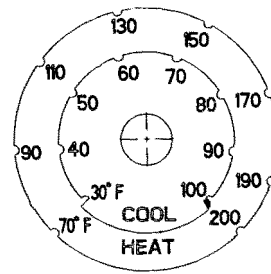

### Heating/Cooling Mode Setting Dip Switch 2 (Setpoint only)



### Output Mode Setting DIP Switch 3

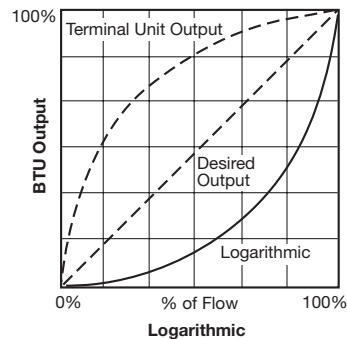
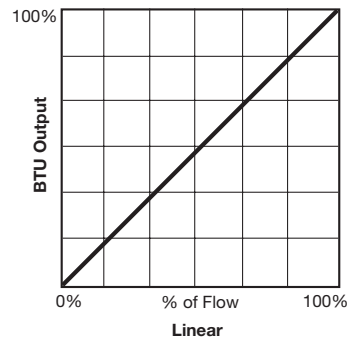
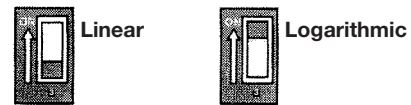

### Gain Setting DIP Switch 4

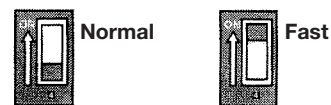

### Pump Exercise Setting DIP Switch 5



## POWER UP SEQUENCE

At initial power up, the NRF-VS will run at full speed for 5 seconds. It will then run at low speed for 5 seconds, before adjusting to the appropriate speed. Monitor the pump at initial power up. If the pump does not operate as indicated above, the Gain (DIP Switch 4) can be adjusted to On (Fast) to increase the minimum power setting.

## OUTPUT LIGHTS

The NRF-VS cover has 6 LED lights to indicate operation and faulty status.

### THE GREEN OUTPUT LIGHT

Represents power to the NRF-VS. When constantly On, the control is powered.

### THE RED OUTPUT LIGHTS

Represent pump speed in increments of 20%. If only one Red light is on, the pump speed is equal to or below 20%. If 2 Red lights are On, the pump speed is equal to or below 40%. When 3 Red lights are On, the pump speed is equal to or below 60%. When 4 Red lights are On, the pump speed is equal to or below 80%. When all Red lights are On, the pump is running from 80% to full speed.

### FLASHING LIGHTS

- This indicates an error in the input signal. If NRF-VS is set to 4-20mA/2-10V, the signal must be below 0.5mA or 0.25V. Check input signal and wiring.
- If NRF-VS is set to Set Point, the sensor has fault status, either shorted or opened. Check sensor wires and Ohm reading against sensor temperature chart.



**WARNING:** The NRF-VS is an operating control only. The boiler must have all safety and limit controls required by code. It is the responsibility of the installer to verify that all the safety and limits are working properly before and after the NRF-VS is installed. Failure to follow these instructions could result in serious personal injury, death and/or property damage.

## PERIODIC INSPECTION

Bell & Gossett products are designed to provide years of trouble free service. It is recommended that periodic inspections be made to check for potential problems with the pump and control. If any leakage or evidence of leakage is present, repair or replace the unit.

## TEMPERATURE SENSOR CHART

TEMPERATURE (in Degrees °F)	Value (in Ohms)
30	17264
35	14985
40	13040
45	11374
50	9944
55	8714
60	7653
70	5941
80	4649
90	3667
100	2914
110	2332
120	1879
130	1524
140	1243
150	1021
160	842
170	699
180	583
190	489
200	412
210	349
220	297
230	253

# Xylem |'zīləm|

- 1) The tissue in plants that brings water upward from the roots;
- 2) a leading global water technology company.

We're 12,500 people unified in a common purpose: creating innovative solutions to meet our world's water needs. Developing new technologies that will improve the way water is used, conserved, and re-used in the future is central to our work. We move, treat, analyze, and return water to the environment, and we help people use water efficiently, in their homes, buildings, factories and farms. In more than 150 countries, we have strong, long-standing relationships with customers who know us for our powerful combination of leading product brands and applications expertise, backed by a legacy of innovation.

**For more information on how Xylem can help you, go to [www.xyleminc.com](http://www.xyleminc.com)**



Xylem Inc.  
8200 N. Austin Avenue  
Morton Grove, Illinois 60053  
Phone: (847) 966-3700  
Fax: (847) 965-8379  
[www.xyleminc.com/brands/bellgossett](http://www.xyleminc.com/brands/bellgossett)

Bell & Gossett is a trademark of Xylem Inc. or one of its subsidiaries.  
© 2012 Xylem Inc. P86271B May 2012